



CAPINTEC
A MIRION MEDICAL COMPANY

ISSUE 3.0



Nuclear Medicine

and Molecular Imaging
Devices and Supplies

ISO 13485:2016
CERTIFIED

Empowering Better, Safer Diagnosis & Treatment

Our Nuclear Medicine products better the human condition by protecting people from exposure during potentially life-saving imaging and therapy.



CAPINTEC
A MIRION MEDICAL COMPANY



Part of Mirion Medical

As part of Mirion Medical, the nuclear medicine and molecular imaging portfolios of Capintec and Biodex have come together under Capintec, a Mirion Medical company. Together, we empower better, safer diagnosis and treatment by enhancing safety and efficiency for technologists and physicists through top-quality nuclear medicine solutions.

At Mirion Medical, we partner with medical professionals to better the human condition. From diagnosis through treatment, we enhance the delivery and ensure the safety of healthcare.



MIRION
MEDICAL

Delivery, Detection and Diagnosis

Dose Calibrators & Accessories	4-21
Thyroid Uptake Systems	22-27
Well Counters & Radio-TLC	28-33
Lung Ventilation Systems & Accessories	35-48
Radiation Monitoring Equipment	50-52
Positioning Devices	53-55
Dispensing Systems	56-57

Lab Supplies

Shielding & Storage	59-92
Lead-lined Cabinets & Enclosures	94-102
Sources & Markers	103-108
Lab Equipment	109-118
Signs, Labels & Tags	120-123
Hot Cells	125-131
Shielded LAF & Fume Hoods	132-135

Imaging Quality Assurance

Phantoms	136-143
----------------	---------

DELIVERY, DETECTION AND DIAGNOSIS

Dose Calibration & Accessories



CRC®-55tR Dose Calibrator

Provides the speed and accuracy you need to measure and prepare doses

The Capintec CRC-55tR Dose Calibrator provides the speed and accuracy you need to measure and prepare doses with the reliability and performance you expect. The CRC-55tR calibrator's design includes a menu-driven, color touch screen interface that is easy to learn and use.

The ion chamber is a time-tested, high pressure chamber Capintec design capable of measuring a dose as high as 6 Ci (250 GBq) with high accuracy.

Additional features such as USB/PC communications, printer capabilities, USB flash drive software upgrades and a plug-and-play chamber make the CRC-55tR calibrator integral in improving your department's efficiency.

The innovative functional design of the CRC-55tR unit allows for a large, easy-to-read display that indicates Nuclide Name, Number, Activity, Unit of Measure and Calibration Number.

Entering data through the custom touch screen interface is fast and includes 28 programmable keys. The user can choose from 80 nuclides by simply selecting the nuclide symbol on the touch screen interface.

Other capabilities include storage of reference sources in memory that automatically decay correct for today's time and date. Automated quality control tests and self-diagnostics are built-in with automatic zero and background subtraction making the CRC-55tR calibrator exceptionally easy to use. An optional printer enables the CRC-55tR unit to print full size records and patient tickets with peel off labels for vial and syringe identification.

Mirion Medical Nuclear Medicine solutions offer excellence in energy measurement, customer service, training and support.

Dose Calibration & Accessories

Features:

- 8 in. color VGA touch screen display
- Single or optional second plug-and-play chamber capability
- Chamber can be placed 100 feet from the readout unit
- Bilingual (English/Spanish) software
- On-screen display of Nuclide Name, Number, Activity, Unit of Measure and Calibration Number
- Large character, high visibility display
- Over 80 Nuclides with half-lives in memory
- Full alphanumeric touchpad
- Built-in dose calibration, quality control and self-diagnostics
- Automated QC including constancy and linearity programs
- Compatible with Nuclear Medicine Management Systems via USB
- Optional printer for full size NRC records and patient labels for syringes and vials
- USB/PC communications
- Software upgrade via USB or flash drive
- USB printer capability
- Automated geometry and linearity testing
- Capable of dual chambers
- Supports exchange of chambers with the CRC®-55tPET Dose Calibrator
- Chamber energy range: 15 keV to 3 MeV

Specifications:

- Console Dimensions: 9.5" h x 9" w x 10.5" l (24 x 23 x 27 cm)
- Console Weight: 7.5 lb (3.4 kg)
- Chamber Dimensions: 17.25" h x 6.76" dia. (43.8 x 17.2 cm)
- Chamber Weight: 30 lb (13.6 kg)
- Chamber Well Dimensions: 2.4" dia. x 10" depth (6.1 x 25.3 cm)
- Ionization Chamber:
 - Type: Thin wall, deep well, high pressure
 - Fill Gas: 12 atm Ultra-Pure Argon
- Measurement Range:
 - Type: Auto Ranging
 - Activity: 250 GBq (6 Ci), max
 - Resolution: .001 MBq (.01 µCi), max
- Display Screen:
 - Type: 8 in. VGA LCD color touch screen display
 - Format: Direct reading in Bq or Ci
 - Bq/Ci Reading: User selectable or fixed
 - Values Displayed: Nuclide name (atomic symbol, mass number), calibration number
- Electrometer:
 - Accuracy: Better than $\pm 2\%$
 - Linearity: Within $\pm 2\%$
 - Response Time: Within 2 seconds, 4 to 16 seconds for very low activity samples

- Repeatability of Measurement:
 - Within $\pm 1\%$ within 24 hours during which time the calibrator is continuously in operation
- Tests:
 - Diagnostics: Full test of program, system memories
 - Daily: Auto Zero, Auto Background Adjust, Data Check, Accuracy and Constancy, Voltage Test
 - Enhanced: Linearity, Geometry, Strip QC
- Nuclear Data:
 - Nuclide Keys: 28 programmable keys
 - System Memory: Over 80 nuclides (cal number and half-life)
- Standard Source Data
 - System Memory: Co-57, Co-60, Ba-133, Cs-137 standard sources
- Molybdenum-99 Assay:
 - Methods: CapMac and canisters
 - Measured Values: Mo-99 elution, Tc-99m, Tc-99m/Mo-99 Ratio
- PC Port:
 - Interface: RS-232 and USB
 - Compatibility: Standard Nuclear Medicine Management Systems
- Printer (Optional):
 - Interface: RS-232 and USB
 - Type: Epson Roll, Epson Slip or Okidata full size dot matrix
 - Printing Options: Full size test reports. Measured results on tickets
- Power Requirements: 100-240 VAC (50/60 Hz) 90 MA
- Cable Length*: 12 ft (3.7 m)
 - Power*: 6 ft (1.8 m)
 - Printer: 6 ft (1.8 m)



*Longer cables are available. Consult factory.

5130-3234 CRC-55tR Dose Calibrator

Related:

- 5430-0058** Epson Roll Printer
- 5430-0100** Epson Ticket Printer
- 7120-1199** CRP-200 Dose Tickets & Labels
- 5130-2046** CAP-MAC-S® Moly Assay Canister for Syringes
- 5130-0006** Moly Assay Canister
- 7300-2004** Chamber Well Insert
- 7300-2450** Environmental Shield
- 7300-2005** Dipper

Dose Calibration & Accessories



CRC®-55tPET Dose Calibrator

Introducing the standard for speed and accuracy in measuring PET isotopes

The Capintec CRC-55tPET dose calibrator combines the ultimate features with the quality and versatility that you've come to expect in one of the industry's finest packages. Using the menu-driven, color touch screen interface, the CRC-55tPET calibrator's reduced chamber pressure and increased bias voltage increases the maximum activity range for high energy PET isotopes. The CRC-55tPET unit's performance and reliability have been designed to meet the demanding needs for speed and accuracy in the preparation and measurement of doses in any laboratory environment.

The enhanced 55t software supports dual chamber technology with an innovative functional design that includes a large, easy-to-read display that specifies Nuclide Name, Number, Activity, Unit of Measure and Calibration Number.

Entering data through the custom touch screen interface is fast and includes 28 programmable keys. The user can select from 80 nuclides by simply selecting the nuclide symbol on the touch screen interface.

Additional capabilities include storage of reference sources in memory that automatically decay corrects for today's time and date. Automated quality control tests and self-diagnostics are built-in with automatic zero and background subtraction making the CRC-55tPET calibrator exceptionally easy to use. An optional printer enables the CRC-55tPET unit to print full size records and patient tickets with peel off labels for vial and syringe identification.

¿Se habla español? The 55t family is bilingual English/Spanish software!

Features including USB/PC communications, printer capabilities, USB flash drive software for upgrades and plug-and-play chamber make the CRC-55tPET calibrator an integral tool in improving your department's efficiency.

Mirion Medical Nuclear Medicine solutions offer excellence in energy measurement, customer service, training and support.

Dose Calibration & Accessories

Features:

- 8 in. color VGA touch screen display
- USB/PC Communications
- Software upgrade via USB or flash drive
- USB printer capability
- Single or optional second plug-and-play chamber with mixed chamber capability
- Chamber can be placed 100 feet from the readout unit
- Bilingual (English/Spanish) software
- On-screen display of Nuclide, Activity, Unit of Measure and Calibration Number
- Large character, high visibility display
- Full alphanumeric touchpad
- Built-in dose calibration, quality control and self-diagnostics
- Has a maximum activity up to 20 Ci of F-18
- Compatible with Nuclear Medicine Management Systems via USB
- Optional printer for regulatory records and patient labels for syringes and vials
- Over 80 nuclide symbols and half-lives in memory
- Automated geometry and linearity testing

Specifications:

- Console Dimensions: 9.5" h x 9" w x 10.5" l (24 x 23 x 27 cm)
- Console Weight: 7.5 lb (3.4 kg)
- Chamber Dimensions: 17.25" h x 6.76" dia. (43.8 x 17.2 cm)
- Chamber Weight: 30 lb (13.6 kg)
- Chamber Well Dimensions: 2.4" dia. x 10" depth (6.1 x 25.3 cm)
- Ionization Chamber:
 - Type: Thin wall, deep well
 - Fill Gas: 5 atm Ultra-Pure Argon
- Measurement Range:
 - Type: Auto Ranging
 - Activity: 20 Curies of F-18
 - Resolution: 0.1 μ Ci (0.01 MBq), max.
- Display Screen:
 - Type: 8 in. VGA LCD color touch screen display
 - Format: Direct reading in Ci or Bq
 - Bq/Ci Reading: User selectable or fixed
 - Values Displayed: Nuclide name (Atomic symbol, Mass number), calibration number
- Electrometer:
 - Accuracy: Better than \pm 2%
 - Linearity: Within \pm 2%
 - Response Time: Within 2 seconds, 4 to 16 seconds for very low activity samples
 - Bias Voltage: +500V

- Repeatability of Measurement:
 - Within \pm 1% within 24 hours during which time the calibrator is continuously in operation
- Overall Accuracy:
 - Accuracy Determined By:
 1. Calibration for the specific nuclide and the sample configuration
 2. Accuracies of standard sources used for calibration of electrometer
- Tests:
 - Diagnostics: Full test of program, system memories
 - Daily: Auto Zero, Auto Background, Voltage Test, Data Check, Accuracy and Constancy
 - Enhanced: Linearity, Geometry
- Nuclear Data:
 - Nuclide Keys: 28 programmable keys
 - System Memory: Over 80 nuclides (Cal number and half-life)
- Standard Source Data
 - System Memory: Co-57, Co-60, Ba-133, Cs-137, Na-22 standard sources
- PC Port:
 - Interface: RS-232 and USB
 - Compatibility: Standard Nuclear Medicine Management Systems
- Printer (Optional):
 - Interface: RS-232 and USB
 - Type: Epson Roll, Epson Slip or Okidata full size dot matrix
 - Printing Options: Full size test reports, measured results on tickets
- Power Requirements: 100-240 VAC (50/60 Hz) 100 mA
- Cable Length*: 12 ft (3.7 m)
 - Power*: 6 ft (1.8 m)
 - Printer: 6 ft (1.8 m)



*Longer cables are available. Consult factory.

- 5130-3235** CRC-55tPET Dose Calibrator
- 5130-2238** CRC-55tPET Multiple Chamber Option

Related:

- 7300-2903** CRC-PS Positron Shield
- 5430-0058** Epson Roll Printer
- 5430-0100** Epson Ticket Printer
- 7120-1199** CRP-200 Dose Tickets & Labels
- 7300-2004** Chamber Well Insert
- 7300-2450** Environmental Shield
- 7300-2005** Dipper

Dose Calibration & Accessories



CRC®-55tW Dose Calibrator Well Counter

A combination of the CRC®-55tR Dose Calibrator and Well Counter

As a combination of the CRC-55tR Dose Calibrator and Well Counter, the CRC-55tW dose calibrators provide advanced features with the speed and accuracy you need to measure activity and prepare doses. Its ion chamber is one of the time-tested, high pressure well designs by Capintec capable of measuring a dose as high as 6 Ci (250 GBq) with high accuracy. The CRC-55tW calibrator features a helpful chamber plug-and-play capability.

For wipe testing, the CRC-55tW calibrator allows the user to define specific counting procedures (protocols) with trigger levels for work, patient, unrestricted areas and sealed source leak tests. The CRC-55tW unit also performs counting functions for wipe tests in as little as six seconds at activities as low as 1 nCi. Low activities are measured with a drilled well high sensitivity Sodium Iodide (NaI) detector.

The well counter includes a 256 channel MCA which provides detailed spectrum for identification and analysis. Manual and automatic ROI selection are available.

The chamber and counter of the CRC-55tW calibrator are combined in a menu-driven, touch screen interface that is easy to learn and use.

Reports software, for the CRC-55tW unit, archives well counter data for quality assurance procedures, wipe measurements and laboratory tests. Well counter reports are stored and searchable by date range for later viewing or printing. Wipe tests are searchable by date range, wipe type, and activity.

Mirion Medical Nuclear Medicine solutions offer excellence in energy measurement, customer service, training and support.

Dose Calibration & Accessories

Features:

- 8 in. VGA touch screen color display
- USB/PC Communications
- Software upgrade via USB or flash drive
- USB printer capability
- Chamber plug-and-play capability
- 28 programmable nuclide keys
- Built-in dose calibration, quality control and self-diagnostics
- Over 80 nuclides in memory
- Automatic chamber QC including linearity
- Hard copy records of data available from optional printer
- Compatible with nuclear medicine information management systems via USB
- 256 channel MCA with detailed spectrum for identification analysis
- Well counter for wipe tests
- User-definable protocols for wipe testing
- Automated well QC including Chi-Square and MDA
- Manual and automatic ROI
- Includes a pre-set key for F-18 measurements
- Reports: Well counter reports for autocalibration, system test, MDA, and Chi-Square are archived and searchable by date, type, and activity
- Automated linearity testing and geometry testing

Specifications:

- Console Dimensions: 9.5" h x 9" w x 10.5" l (24 x 23 x 27 cm)
- Console Weight: 7.5 lb (3.4 kg)
- Chamber Dimensions: 17.25" h x 6.76" dia. (43.8 x 17.2 cm)
- Chamber Weight: 30 lb (13.6 kg)
- Chamber Well Dimensions: 2.4" dia. x 10" depth (6.1 x 25.3 cm)
- Well Counter Dimensions: 9.38" h x 6" dia. (23.8 x 15.2 cm)
Well Counter Weight: 15.2 lb (6.9 kg)
Well Diameter: .67" (1.7 cm)
Well Depth: 1.5" (3.8 cm)
Cable Length: 9 ft (2.7 m)
- Well Detector
Type: Sodium Iodide (NaI) drilled-well crystal detector
256 Channel MCA, manual and automatic ROI
Warning Trigger Levels: User-definable
Tests: Daily test, energy calibration, and reproducibility
Enhanced QC includes Chi-Square and MDA
- Ionization Chamber
Fill Gas: 12 atm Ultra-Pure Argon
Measurement: Auto ranging
Activity Range: Up to 6 Ci (250 GBq)
Resolution: .001 MBq (.01 μ Ci)
Response Time: Within 2 seconds, for low activity sample, 4 to 16 seconds
Tests: Daily tests include Auto Zero, Background Adjustment, Voltage Test, Data Check, Accuracy and Constancy
Enhanced QC includes linearity, geometry, strip QC

- Display Screen
Type: 8 in. VGA LCD color touch screen display
Bq/Ci Reading: User selectable or fixed
Activity Display: Selected radionuclide, calibration number, measured activity and display units (Bq/Ci)
Count Rate Values: Wipe results
- Electrometer
Accuracy: Better than $\pm 2\%$
Linearity: Within $\pm 2\%$
- Repeatability of Measurement
Within $\pm 1\%$ within 24 hours during which time the calibrator is powered at all times
- Nuclide Data
Nuclide Setting Keys: 28 programmable keys
System Memory: Over 80 nuclides (cal number and half-life)
A pre-set key measures up to 2.0 Ci (74.0 GBq) of F-18
- Standard Source Data
System Memory: Co-57, Co-60, Ba-133, Cs-137
- Molybdenum-99 Assay
Methods: CapMac and canisters
Measured Values: Mo-99 elution, Tc-99m, Tc-99m/Mo-99 ratio
- PC Port
Interface: RS-232 and USB
Compatibility: Standard Nuclear Medicine Management Systems
- Printer
RS-232 and USB Ports
Epson Roll, Epson Slip or Okidata dot matrix
- Tests
Diagnostics: Full test of program, system memories
- Power Requirements: 100-240 VAC (50/60 Hz) 100 mA
- Cable Length*: 12 ft (3.7 m)
Power*: 6 ft (1.8 m)
Printer (optional): 6 ft (1.8 m)



*Longer cables are available. Consult factory.

5130-2216 CRC-55tW Dose Calibrator

Related:

- 5420-2072** Well Auxiliary Shield, CAPRAC-t, 55TW
- 5430-0058** Epson Roll Printer
- 5430-0100** Epson Ticket Printer
- 7120-1199** CRP-200 Dose Tickets & Labels
- 7300-2004** Chamber Well Insert
- 7300-2450** Environmental Shield
- 7300-2005** Dipper

Dose Calibration & Accessories

for
NUCMED

for
PET



CRC®-77tHR Dose Calibrator

*High-activity measurements
for isotope production environments*

The CRC-77tHR calibrator's performance and reliability have been designed to meet the unique and demanding needs of the isotope manufacturing and radiopharmaceutical production environments.

The software is designed for rapid repeatable measurement functions often required in production, and includes a fully automated Quality Assurance Program. Hardware is carefully designed to minimize the impact of high radiation fields upon electronics. A touch screen user interface provides a user-friendly and efficient workflow.

Some features include a high activity range of over 400 Curies for Tc-99m, USB/PC communications, and pre-defined communication protocols for fast and easy system interface.

We offer a full line of related Capintec products to safely use the CRC-77tHR calibrator within your hot cell or hood environment.

Features:

- Maximum Activity for 77tHR is 400 Curies (15 TBq)
- Radiation resistant design
- Custom length liners and dippers available to match your hot cell dimensional requirements
- 8 in. color VGA touch screen display
- On-screen display of Nuclide Name, Number, Activity, Unit of Measure and Calibration Number
- Large character, high visibility display
- Over 80 nuclides with half-lives in memory
- Full alphanumeric touchpad
- Built-in dose calibration, quality control and self-diagnostics
- Automated QC including constancy and linearity programs
- Compatible with Nuclear Medicine Management Systems via USB
- Optional printer for full size hard copy records
- USB/PC communications
- Software upgrade via USB or flash drive
- USB printer capability
- Automated geometry and linearity testing

Dose Calibration & Accessories

Specifications:

- Console Dimensions: 9.5" h x 9" w x 10.5" l (24 x 23 x 27 cm)
- Console Dimensions: 9.5" h x 9" w x 10.5" l (24 x 23 x 27 cm)
- Console Weight: 7.5 lb (3.4 kg)
- Chamber Dimensions: 17.25" h x 6.76" dia. (43.8 x 17.2 cm)
- Chamber Weight: 30 lb (13.6 kg)
- Chamber Well Dimensions: 2.4" dia. x 10" depth (6.1 x 25.3 cm)
- Ionization Chamber:
 - Type: Thin wall, deep well
 - Fill Gas: 5 atm Ultra-Pure Argon
- Measurement Range:
 - Type: Auto Ranging
 - Activity: 15 TBq (400 Ci), max Tc-99m, 4.8 TBq (130 Ci), max F-18
 - Resolution: 0.01 MBq (10 μ Ci), max.
 - Energy: 15 keV to 3 MeV
 - Not recommended for activity measurements < 100 μ Ci
- Display Screen:
 - Type: 8 in. VGA LCD color touch screen display
 - Format: Direct reading in Bq or Ci
 - Bq/Ci Reading: User selectable or fixed
 - Values Displayed: Nuclide name (atomic symbol, mass number), calibration number
- Electrometer:
 - Accuracy: Better than \pm 2%
 - Linearity: Within \pm 2%
 - Response Time: Within 3 to 4 seconds, 5 to 25 seconds for low activity samples
- Repeatability of Measurement:
 - Within \pm 1% within 24 hours during which time the calibrator is continuously in operation
- Tests:
 - Diagnostics: Full test of program, system memories
 - Daily: Auto Zero, Auto Background Adjust, Data Check, Accuracy and Constancy, Voltage Test
 - Enhanced: Linearity, Geometry
- Nuclear Data:
 - Nuclide Keys: 28 programmable keys
- Standard Source Data:
 - System Memory: Co-57, Co-60, Ba-133, Cs-137 standard sources
- PC Port:
 - Interface: USB
 - Compatibility: Standard Nuclear Medicine Management Systems

- Printer (Optional):
 - Interface: USB
 - Type: HP Inkjet
 - Printing Options: Full size test report
- Power Requirements: 100-240 VAC (50/60 Hz) 100 mA
- Cable Length: 12 ft (3.7 m)
 - Power: 6 ft (1.8 m)



5130-30261 CRC-77THR Dose Calibrator

Related:

- 7300-2903** CRC-PS Positron Shield
- 5120-2258** Custom Length Dipper
- 5120-2257** Custom Length Liner
- 5126-2001** Positron Shield Stand
- 5130-30251** CAP-Lift
- 5250-0022** CAP-RAD Smart Area Monitor

Call for information for the 3-Part Sliding Door Hot Cell and Vertical Hot Cell: Call for information

Dose Calibration & Accessories



CRC®-PC Smart Chamber

Network ready with remote connectivity

The CRC-PC Smart Chamber combines the well-known and highly reliable measurement Capintec™ chamber with an innovative web-based user interface to meet today's business requirements. Remote connectivity and network-ready interface set the Smart Chamber apart as the most advanced in dose calibration.

The CRC-PC Smart Chamber is available in two fill pressures. For unit dose hot labs, the HL model provides excellent low activity sensitivity while covering a wide clinical range of activities. For radiopharmacies, the lower fill pressure of the pharmacy RPh model extends the activity range to accommodate the higher activity yields of today's generators and cyclotron sites.

The innovative functional design of the PC Smart Chamber provides a small footprint, and direct interface to Nuclear Medicine Management Systems with remote viewing capability.

Additional features include Ethernet software upgrades, plug-and-play chamber, and user adjustable threshold for faster response.

Mirion Medical Nuclear Medicine solutions offer excellence in energy measurement, customer service, training and support.



Dose Calibration & Accessories

Features:

- Connects to network infrastructure so that display can be viewed from any network PC (remote viewing)
- Direct interface to Nuclear Medicine Management Systems - no readout required
- Ethernet Communications
- Automated QC
- Software upgrade via Ethernet interface
- Built-in database to store QC, Moly and User Log
- Power over Ethernet or USB port
- User adjustable threshold for faster response times
- Small footprint
- User manual viewable on PC

Specifications:

- Console Dimensions: 9.5" h x 9" w x 10.5" l (24 x 23 x 27 cm)
- Console Dimensions: 9.5" h x 9" w x 10.5" l (24 x 23 x 27 cm)
- Console Weight: 7.5 lb (3.4 kg)
- Chamber Dimensions: 17.25" h x 6.76" dia. (43.8 x 17.2 cm)
- Chamber Weight: 30 lb (13.6 kg)
- Chamber Well Dimensions: 2.4" dia. x 10" depth (6.1 x 25.3 cm)
- Chamber Dimensions 18.1" h x 6.76" w x 2.75" dia. (45.8 x 17.17 x 2.75 cm)
- Chamber Liner Insert: 2.74" dia. (6.9596 cm)
- Chamber Weight: 39.3 lb (17.8 kg)
- Well Dimensions: 2.4" dia. x 10" depth (6.1 x 25.4 cm)
- CRC-PC Smart Chamber:
 - HL System: Item #5130-30255
 - RPh System: Item #5130-30256
 - HL Chamber: Item #5130-20253
 - RPh Chamber: Item #5130-20254
- Ionization Chamber:
 - Type: Thin wall, deep well, sealed and pressurized
 - Fill Gas: Ultra-Pure Argon
- Electrometer:
 - Accuracy: Better than $\pm 2\%$
 - Linearity: Within $\pm 2\%$
 - Response Time: Within 2 sec, 4 to 16 sec for very low activity samples
- Repeatability of Measurement:
 - Within $\pm 1\%$ within 24 hours during which time the calibrator is continuously in operation
- Tests:
 - Diagnostics: Full test of program, system memories
 - Daily: Auto Zero, Auto Background Adjust, Data Check
 - Accuracy and Constancy, Voltage Test
- Nuclear Data:
 - 30 User Nuclides
 - Over 80 built-in nuclides (cal number and half-life)

- Measurement Range:
 - Type: Auto Ranging
 - HL (hot Lab) 6 Ci Tc-99m, 2 Ci F-18
 - RPh (pharmacy) 72 Ci Tc-99m, 20 Ci F-18
- Standard Source Data:
 - System Memory: Co-57, Co-60, Ba-133, Cs-137, Na-22 standard sources
- Molybdenum-99 Assay:
 - Methods: Canisters and CAP-MAC
 - Measured Values: Mo-99 elution, Tc-99m, Tc-99m/Mo-99 Ratio
- PC Port:
 - Interface: Ethernet
 - Compatibility: Standard Nuclear Medicine Management Systems
- PC Power Requirements:
 - 100-240 VAC (50/60 Hz) 3 A max
- Chamber Power:
 - USB: 5 VDC, 0.5 A
 - Power over Ethernet (PoE): 48 VDC, 0.35 A



- 5130-20253** CRC-PC Smart Chamber HL Chamber
- 5130-20254** CRC-PC Smart Chamber RPh Chamber

Related:

- 5130-0006** Molly Assay Canister
- 7300-2450** Environmental Shield
- 7300-2004** Chamber Well Insert
- 5130-2046** CAP-MAC-S® Moly Assay Canister for Syringes
- 7300-2005** Dipper

Dose Calibration & Accessories



Moly Assay Canister

Measures Molybdenum Content of Tc-99m

Verify that the amount of Mo-99 contamination in your vial of Tc-99m is within NRC or state regulatory limits with a molybdenum assay canister. Use it with all Capintec dose calibrators. The kit has a lead canister and a wire basket to ensure proper placement of the Tc-99m vial in the ionization chamber. It is designed to accommodate all vials up to 30 ml without changing parts or dose calibrator settings.

Specifications:

- Overall height including wire handle: 10.06" (25.5 cm)
- Handle width: 3.75" (9.5 cm)
- Canister diameter: 2.10" (5.3 cm)
- Canister height: 3.68" (9.3 cm)
- Lead Thickness: 0.5" (1.2 cm)

5130-0006 Moly Assay



CAP-MAC-S® Moly Assay Canister For Syringes

Measures Mo-99 in Tc-99m unit doses

The CAP-MAC-S kit is similar to the moly assay canister, but is specially designed for unit-dose syringes of Tc-99m labeled radiopharmaceuticals. Use the CAP-MAC-S kit to verify that the amount of Mo-99 contamination in unit doses is within NRC or state regulatory limits. It fits all Capintec dose calibrators. The CAP-MAC-S kit has a lead canister and a wire basket to ensure proper placement of the syringe in the ionization chamber. It is designed to accommodate all syringes up to 30 ml without changing parts or dose calibrator settings.

5130-2046 CAP-MAC-S

Dose Calibration & Accessories



Mounting Flange

A must for all hot labs with limited counter space

The Mounting Flange allows the chamber for the CRC-25R kit to be mounted in a cabinet or fume hood flush with the surface of the counter top, saving counter space. This is a MUST for all hot labs with limited counter space.

This mounting unit is designed to be used with the chamber for the CRC-25R calibrator. It can also be used for the CRC-15 Ultra, and the CRC-127R unit. The flange is made of attractive brushed aluminum that lies flat against the counter top. It allows the well liner insert to be installed from the top and permits removal of the well for cleaning or decontamination.

The flush Mounting Flange is easily installed in existing or new cabinets or hoods. Drawings are available upon request.

7310-2307 Mounting Flange



Vial/Syringe Dipper

Ensures proper placement every time

Every calibrator comes with a sample holder. Sometimes known as the dipper, this holder is specially designed to hold syringes and vials of all sizes. You can order additional sample holders as a separate item.

The sample holder offers a safe, convenient way to hold a vial or syringe during activity measurement. Proper placement in the dose calibrator is assured every time. New material in the shaft reduces breakage for longer life, and eliminates the attenuation problems of low-energy gamma emissions that occur with other dippers. Syringe inserts available for tuberculin syringes (1.0 ml).

7300-2005 Dipper

Dose Calibration & Accessories



Environmental Shield

Nine Interlocking lead rings surround chamber

Reduce background radiation more than 10 times with the environmental shield. Fitting any Capintec CRC dose calibrator with a remote ionization chamber, the shield consists of nine interlocking lead rings that surround the chamber. Uniform wall thickness (4 cm standard, or 1 1/2") also reduces radiation exposure during calibration. The lead contains 3% antimony for added strength. For use with CRC-25R, CRC-25W, CRC-712M units, and CRC® Ultra.

7300-2450 Environmental Shield



Positron Shield

Constructed with nine sets of split lead rings, provides maximum radiation protection

Constructed of nine sets of 2 1/4" (6 cm) thick lead split rings for full shielding of a dose calibrator chamber. The positron shield gives maximum radiation protection when working with 511 keV nuclides. The shield can either be flush mounted to a work surface or mounted on a table or cabinet.

Specifications:

- Weight: 560 lb (254 kg)

7300-2903 Positron Shield



Positron Shield Stand

Solidly built to support a Capintec dose calibrator encased in the Positron Shield

Features:

- 3-Legged stand made of arc-welded steel
- Capintec will custom design to meet your exact specifications

Specifications:

- Standard Range of height with adjustable feet is 22.875" to 25.375" (58 x 64 cm)

5126-2001 Positron Shield Stand

Dose Calibration & Accessories



Chamber Well Insert

Protects chamber well, easily washable with decontaminant

Every Capintec dose calibrator in the CRC family already comes with this protective chamber well insert. If it becomes contaminated, you can easily remove it for washing with a decontaminant. Or, you can buy an extra chamber well insert to use until the other one decays to background levels.

The chamber well insert is made of clear, tough plexiglass for improved durability, reduced breakage, and longer life.

7300-2004 Liner



Copper Liner

Eliminates variations in readings when measuring I-123

This liner eliminates variations in readings when measuring I-123. It receives a standard dipper.

Specifications:

- Dimensions: 11.75" l x 2.75" dia. (29.8 x 5 cm)

5120-2286 Copper Liner

Dose Calibration & Accessories



Auxiliary Shield

CAPRAC®-t, 55tW, 25W, Ultra Well

The CAPRAC Wipe Test/Well Counter is a very sensitive system which uses a NaI detector that can be affected by high background activity or changes in the room background during counting periods. If the CAPRAC is used in a location which might have a high background, an Auxiliary Shield can be used to reduce background levels. The Auxiliary Shield walls and top are 0.5" thick. The top lid has a handle for easy removal. The shield fits snugly around the well chamber and can be easily installed or removed.

Specifications:

- Dimensions: 9 3/4" h x 4" w (24.7 x 10.1 cm)
- Weight: 22 lb (10 kg)

5420-2072 Well Auxiliary Shield, CAPRAC-t, 55TW



PET Auxiliary Shield

PET auxiliary shield for the 55tW and CAPRAC-t counter

The Well Auxiliary Shield is made with 1.5" thickness for shielding and sits on its own supporting base. The shield fits snugly around the well chamber for a total of 2" and can be easily installed or removed, as needed.

Specifications:

- Dimensions: 15.625" h x 7.5" w x 6.75" d (39.6 x 19 x 17 cm)
- Weight: 90 lb (40.8 kg)

5420-2141 PET Auxiliary Shield



Mick Bard Source Holder

This seed holder is specifically designed to hold seed cartridges. This device allows cartridges to be properly placed in any Capintec standard length Dose Calibrator chamber for the most accurate and reproducible measurement available.

5120-1238 Mick-Bard Source Holder

Dose Calibration & Accessories



CALICHECK Linearity Test Kit

The innovative CALICHECK linearity test kit provides system testing of a dose calibrator in less than 10 minutes. The CALICHECK attenuates Tc-99m by known values.

Simulating decay for a range of a few hours up to four days, the CALICHECK eliminates the need to fractionate eluants or decay them for several days while periodically collecting data.

The unique design of seven color-coded, lead-wrapped tubes allows for accurate testing. They are complete with their own storage container and record-keeping sheets with easy-to-follow instructions.

Features:

- Performs linearity
- Accurately simulates decay down to 10 μCi
- Results comparable to standard linearity tests
- Meets NRC and state standards

5120-2144 CALICHECK Linearity Kit

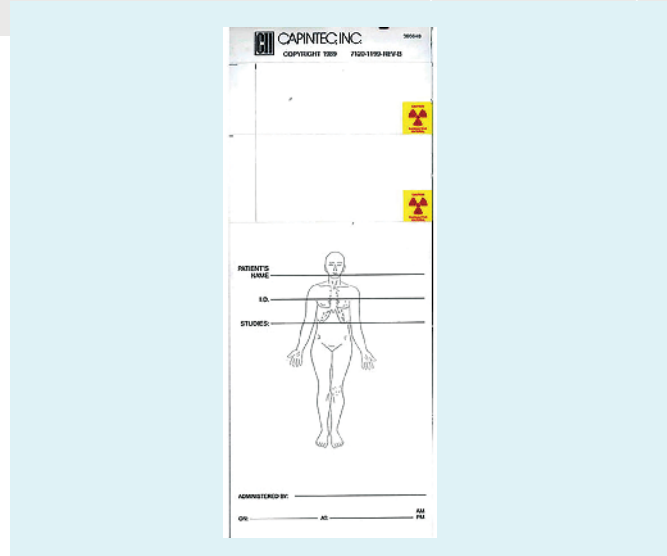

CRP-200 Dose Tickets And Labels

Duplicate tickets with peel-off, self-stick labels

By popular demand we have added the "little patient" to this ticket making it possible to mark the site of injection. Also included, for your convenience, is a place to write the patients Name, I.D. number, Study performed, who administered the dose and when used with the CRC-25R, 25W, or Ultra, one pass through the printer, produces two copies of each ticket and two easy to remove peel-off labels.

All tickets and labels are easily separated after printing. Use them for patient charts, department log books, and syringe or vial shields. A special adhesive makes labels easy-to-remove after use.

7120-1199 CRP & CRC 200 Dose Tickets and Labels 250/pkg.

7120-1240 CRP & CRP 200C Dose and Label Tickets 1500/case

Dose Calibration & Accessories



CAP-Lift™

Hands-free dose measurements

Features:

- Reduces hand and body exposure
- Stainless steel construction
- Auto return to elevated dose reception position
- Small size hand control and/or optional foot switch
- Standard and optional custom lengths
- Color-coded supply lines
- Perfect alignment with all Capintec dose calibrators
- Pneumatic system for faster operations
- No electrical power needed
- Foot pedal accessory included

Specifications:

- Height of lift mechanism: 19.25" (48.9 cm) from top of chamber
- Diameter of lift stand: 6" (15.25 cm) at top of chamber
- Travel: 8" (20.3 cm) (Standard) Custom travel lengths available for situations where lift stand is not sitting directly on the chamber
- Control Box Dimensions: 4" h x 4" w x 2" d (10.1 x 10.1 x 5 cm)

5130-30251 Standard CAP-Lift

Related:

5130-20252 Foot Pedal

Replacement:

5120-20302 Replacement Dipper

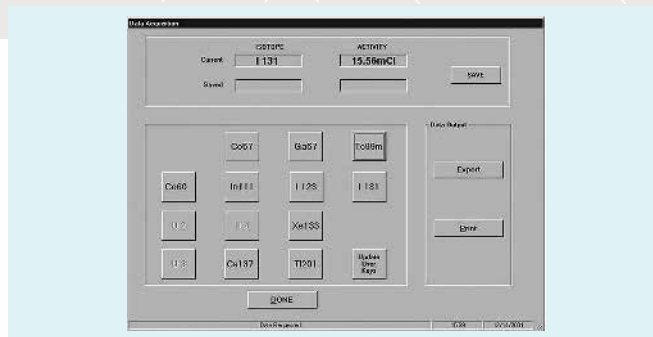

CRC-55t (R, W & PET) PC Series Communications Software

Fast and easy data acquisition - track, record and store dose calibrator measurements on your PC

CRC® PC Communications software will allow for faster and easier data acquisition and storage to your computer. Measurement data, including isotope name and activity, will be transmitted and stored on your PC via an RS232 interface port and the Dose-Link Software package. Ideal for maintaining regulatory compliance, research studies or use in production facilities.

The PC Communications software will create an interface between your CRC-55t (R, W & PET) dose calibrator and your PC. The Dose Link program has four modes of operation:

Acquire and Store Data

Each second the name and activity of the isotope selected on the dose calibrator console will be updated by the program. This data can be saved and exported to an Excel spreadsheet.

Repetitive Acquisitions

Following user-defined parameters of time intervals and number of measurements, activity and isotope data are acquired and saved. The data can then be printed or exported. Great for performing quarterly linearity tests (you don't even have to be there).

Maximum Activity Acquisition

The activity and isotope are updated and displayed at time intervals defined by the user, when data acquisition is stopped, the maximum activity and time will be saved and can be printed or exported.

The CRC PC Communications software is easy to install, easy to use and almost as cost conscious as you are. Help your department maintain accurate record keeping without breaking the department budget.

0960-0183 PC Communication Software Disc; CRC-55t (R, W & PET)

Dose Calibration & Accessories



Epson Roll Printer

For CAPRAC-t, CRC-25W, CRC-55tW, CAPRAC, CAPRAC-R

An Epson printer is provided as an option for the CAPRAC-t, Caprac, Caprac-R, CRC-25W, CRC-55tW Wipe Test/Well Counters. This sturdy, high-quality printer provides graphic output with wipe reports, showing the peak energy range of the nuclides on the wipe. The printer utilizes a black/red ribbon to report wipes that are higher than the trigger levels for contamination. Abnormal values are printed in red for easy/fast identification.



Epson Ticket Printer

Allows individual tickets to be positioned easily for printing

This hard-working printer made by Epson is offered as an option for the CRC-25 and CRC-55t Families of Dose Calibrators, CRC-Beta Enhanced Counter, CAPRAC and the CAPRAC-R Well/Wipe Counters. It allows individual tickets to be positioned easily for printing. The printer automatically aligns the ticket and after printing feeds it out the back. Although designed for tickets, standard paper can be used and is printed along one side. Suggested tickets for the Ticket Printer are the CRP-200 and CRP-700.



5430-0058 Epson Roll Printer

Related:

9282-0009 Paper, 12/rolls

2001-0055 Printer Ribbon



5430-0100 Epson Ticket Printer

DELIVERY, DETECTION AND DIAGNOSIS

Thyroid Uptake Systems

Captus® 4000e Thyroid Uptake System

Large touch screen interface. Fully integrated DICOM

The Captus 4000e unit is a comprehensive Nuclear Medicine Measurement System, with specific software modules for thyroid uptake, bioassay, wipe tests, automated quality assurance tests, and isotope library. The system includes a fully functional 1024 channel MCA with auto and manual calibration. Timed activity mode features a programmable repetitive timed measurement program. Improved menu-driven workflow and large 20" color touch screen streamlines user interface.

The optional fully integrated DICOM interface communicates directly with hospital information systems and can transfer patient, wipe test, and QC data. Custom Protocol is included as standard, and Microsoft Office Professional 32-bit software is optional.

The improved stand provides ergonomically adjustable monitor and easy-to-position articulating collimator arm. Four sided comfortable handle grips and swivel wheels ensure easy mobility. PC can be attached to either right or left side to optimize workspace.

Features:

- Color touch screen user interface
- Large 20" all-in-one touch screen computer
- Optional fully integrated DICOM interface for patient data, QC and wipe tests
- Custom Protocol included as standard
- Ergonomically designed mobile stand
- Articulating arm with wide range of motion
- Medical-grade Corian countertop with document storage shelf
- Secure neck phantom storage location
- Source holder for reproducible QC positioning
- Microsoft Office Professional 2010 option

SOFTWARE:

Diagnostics and Tests

- Fully automated Quality Assurance Section includes energy calibration, zero adjust, gain adjust, detector efficiency, detector resolution, chisquare, constancy, and MDA
- Manual calibration available in MCA module

Thyroid Uptake

- Provides four predefined protocols
- Supports both capsule and liquid dose formats
- Dose may be pre-counted before patient assignment
- Predose measurement option
- Normal range option

Wipe Tests

- Setup for multiple groupings
- Isotope identification available
- Spectrum is displayed for each wipe
- Activity exceeding trigger levels flagged in red



MCA

- 1024 channels
- Automated and manual calibration selection
- Preset or user defined ROI
- Count set by real time, live time, or total peak counts
- Timed activity feature enables predefined continual repetitive measurements

DICOM Interface (Optional)

- Fully integrated interface with Captus 4000e System
- Retrieve patient data from worklist
- Upload patient, wipe test, and QA reports

Bioassay

- Monitors Staff for I-123, I-125, and I-131 exposure
- User defined action levels for each isotope
- Individual and summary reports available

Custom Protocol

- Create Custom Measurement Sequence
- Customizable Reports

Reports

- Reports include full spectrum graphics
- Thyroid report includes time vs. uptake value graph
- Data is archived
- Reports can be printed or saved as a .pdf file

POWER:

Line Voltage

- 120 VAC, 60 Hz, 2.6 AMP
- 230 VAC, 50 Hz, 1.1 AMP
- Isolation Transformer with hospital grade cord and plug

Thyroid Uptake Systems

SPECIFICATIONS:

Thyroid Uptake Stand

- Ergonomically designed floor stand
- Medical-grade Corian countertop with shelf
- Adjustable height PC stand, left or right side mounting
- Articulating arm with 34" vertical range of travel and 220° collimator rotation
- Protective cable management system
- Neck phantom storage location
- Fully protected internally routed cables
- Four heavy-duty locking casters that swivel 360°
- Isolation transformer for patient and user safety
- QA source holder for reproducible geometry

Computer

- 20" All-in-One Touch Screen Flat Panel Computer
- Windows 10 Platform

Printer

- Color Ink Jet printer

Uptake Detector

- 2" dia. 14-pin NaI(Tl) detector with 1.55" depth and 0.66" dia. well
- Flat field collimator meets ANSI N44.3, IAEA
- Precision measurement and alignment rod, which measures distance directly to thyroid

Well Counter

- 2" dia. NaI(Tl) well detector with 1.55" depth and 0.66" dia. well
- 1" lead well shield with brass liner
- (Optional 2" shield available)

Multichannel Analyzer Interface PC Board

- Two detector inputs
- 1024 Channels
- Maximum count rate: 200,000 cps at 5%
- Count Rate Linearity: Within 2% up to 150,000 cps
- ROIs automatic or manual
- Differential Linearity <2% over the top 98% of channels
- Integral Linearity <1% over the top 98% of channels
- Presets live time, real time, total counts
- Automatic peak finding
- Software controlled lower level discriminator

Thyroid Uptake Stand Dimensions

- Closed Storage Position: 56" h x 28" w x 32" d (142 x 71 x 81 cm)
- Arm able to extend 36" (91 cm) horizontally beyond shelf
- Vertical travel 25" to 63" (64 to 160 cm)
- Weight: Uptake System: 340 lb (154 kg)
- Weight with 1" Shielded Well: 410 lb (186 kg)
- Weight with 2" Shielded Well: 540 lb (245 kg)

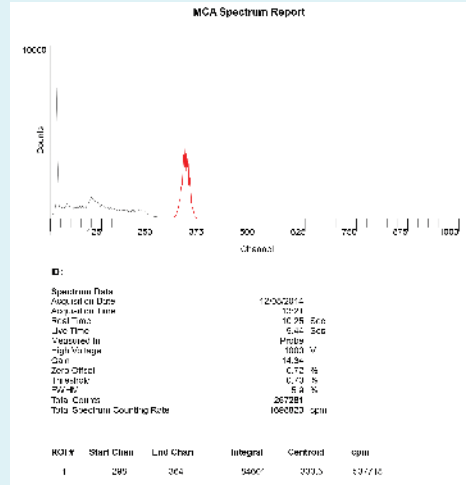

Captus 4000e Reports

Reports include color graphics and isotope spectrum. Thyroid report includes time vs. uptake value graph. Out of range results are flagged. Reports can be printed or saved as .pdf files.

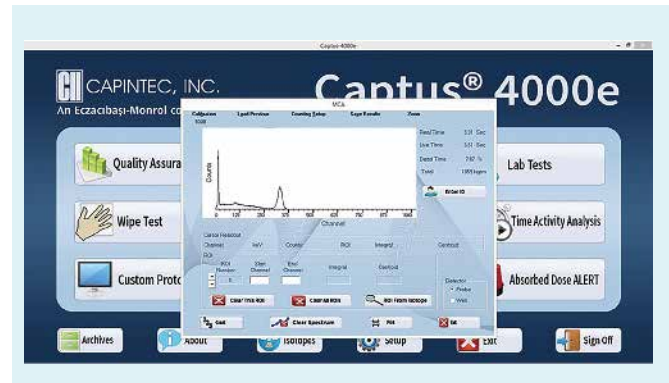

- 5430-30151** Captus 4000e Thyroid Uptake System
- 5430-30152** Captus 4000e Thyroid Uptake System with Well
- 5430-30154** Captus 4000e Thyroid Uptake and Well Counting System with 2" Well Shielding
- 5430-00007** Captus 4000e DICOM Interface

- Related:**
- 5230-0038** Neck Phantom
 - 5420-2164** Well Detector 2" Shield
 - 7315-1850** Rod Source Holder

Thyroid Uptake Systems

Cap-DICOM™ Software Compatibility for the Captus 4000e System

Gain the advantage of DICOM connectivity

With Cap-DICOM software, the Capintec Captus 4000e system gains the advantage of DICOM connectivity. Cap-DICOM software adds DICOM Modality Worklist (MWL) and DICOM export to the Captus 4000e system. This solution allows patient information and demographics to be pulled from the Radiology Information System (RIS) or Hospital Information System (HIS), thus, reducing errors and time associated with the manual input of patient information.

Cap-DICOM software creates a DICOM secondary capture image from information generated during the uptake procedure. The software exports the DICOM image files to a destination DICOM C-Store provider specified by the user. This destination may be a nuclear medicine workstation or PACS (Picture Archive and Communication System).

Features:

- Integrates the Captus 4000e system into a DICOM Radiology Information System and PACS environment
- Supports multiple vendors for nuclear medicine workstations, RIS and PACS systems
- Increases department efficiency and workflow
- Reduces errors associated with the manual input of patient information
- Increases accuracy of patient information in the PACS environment
- Merged uptake reports with thyroid scans can be displayed as a DICOM image
- Improved physician efficiency in interpretation and clinical review of the combined thyroid uptake report and imaging procedure
- Configurable options integrate nuclear medicine into the RIS and PACS environment
- Ability to query the worklist provider by accession number, patient ID, patient name or date
- Intuitive, easy-to-read user interface to quickly sort and search the worklist
- Ability to correct patient information before exporting
- Ability to review final reports before exporting to a nuclear medicine workstation or PACS
- Current Captus 4000e users can upgrade to Cap-DICOM capabilities
- Cap-DICOM options queries the HIS/RIS for the DICOM Modality Worklist and places patient demographics in the Captus 4000e database, eliminating the need to manually enter patient information

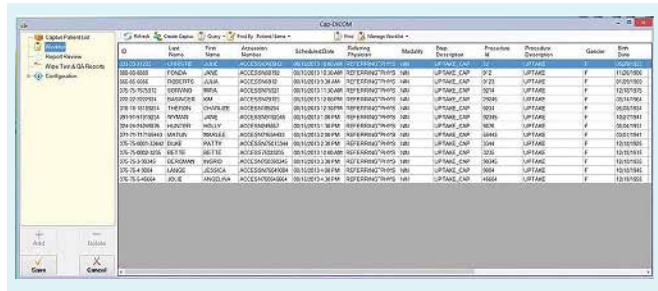
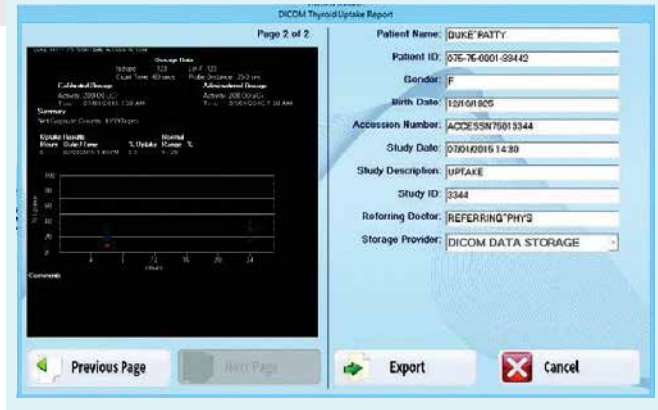

DICOM Conformance

- C-Store User
- C-Store Provider
- Modality Worklist User



5430-0007 Cap-DICOM® Software – Captus® 4000e

Thyroid Uptake Systems



Wipe Spot Pads

Soft, highly absorbent cotton pads

Ultra-absorbent Wipe Spot Pads easily absorb any removable contamination for wipe testing. These wipe pads are backed by a card with space for indicating the wipe location, date and time, activity found, and the initials of the user. These soft, highly absorbent cotton pads may be used either wet or dry to discover contamination.

The Wipe Spot Pads are packed 500 to a box. The adhesive backing allows the wipe to be folded back upon itself and inserted into a test tube for counting.



Captus Neck Phantom

Designed to represent a patient's neck

The Captus neck phantom is made of clear Lucite designed to represent a patient's neck. The phantom has a two part insert that allows counting in a bottle or vial, as well as capsule counting. The unit is etched to show where the caliper of the thyroid probe should be placed for proper alignment. The phantom allows for placement in a vertical or horizontal position. This phantom meets all suggested requirements for use in counting a thyroid uptake standard source.

5420-0086 Wipes, 500/box
006-350 Wipe Test Kits, 1.75" dia., 500/pkg
006-352 Wipe Test Kits, .5" dia., 500/pkg

5230-0038 Captus Neck Phantom

Thyroid Uptake Systems



Counting Test Tubes

Popular size 12 x 75 mm test tubes are available boxed and oriented in one direction for ease of use. The re-closable box minimizes scratches and damage during storage and protects the unused tubes. Box contains 250 tubes.

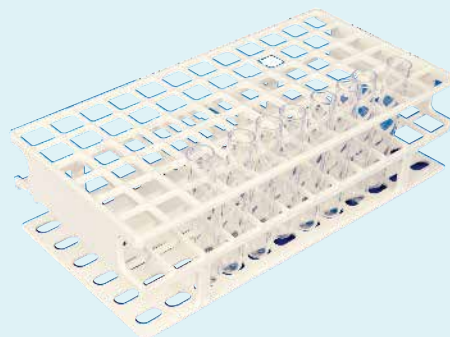

Uniwire Test Tube Rack

Single mold design

Stackable with a single mold design that is coated with Nalgene® and easily cleaned, these racks are designed to hold the counting tubes above and hold up to 40 tubes.

0670-0016 Counting Tubes, 250/box

0670-0022 Uniwire Test Tube Rack
Accommodates 0670-0016 Test Tubes.

Thyroid Uptake Systems



Rod Source Holder

Available boxed and oriented in one direction for ease of use

Designed to provide precise, reproducible positioning of check sources in the thyroid uptake collimator. Easy to clean, and break resistant.



Captus Well Liner

The well liner is made of a very thin plastic that is used with the Drilled Well Crystal.

DELIVERY, DETECTION AND DIAGNOSIS

Well Counters & Radio-TLC

CAPRAC-t Wipe Test/Well Counter

No need to worry about meeting the regulations in 10 CFR Part 35.315 (200 dpm requirements for unrestricted areas and iodine contamination). The Capintec CAPRAC-t Wipe-Test Counter handles all of them.

Measure for measure, no other well counter offers the speed, accuracy and complete range of built-in features provided by the compact CAPRAC-t counter. It performs a wipe test in just six seconds (for 1 nCi) and detects extremely low levels of activity with the accuracy only a NaI drilled-well detector can provide.

The CAPRAC-t system can also serve as a single-well gamma counter in departments that do not need multi-sample changers. User-defined protocols, trigger levels, and counting times are a "snap". A 256-channel pulse-height analyzer permits built-in gamma spectroscopy. Definable conversion factors for specific radionuclides allow the CAPRAC-t counter to calculate results in cpm, dpm, nCi, cps, dps, or kBq. The CAPRAC-t unit also displays full spectrum.

The CAPRAC-t counter is engineered and built for years of consistent, reliable performance and is curie or becquerel selectable. The unit has automatic background subtraction and self-diagnosis programs for systems testing with optimized signal-to-noise ratio. It includes a lead outer shield (1.3 cm thick) with optional auxiliary shield available.



Features:

- 8" SVGA touch screen color display
- 256 channel MCA with detailed spectrum for identification analysis
- NaI drilled-well crystal detector
- Automatic energy calibration, constancy check, and background subtraction
- Automated well QC including chi-square and MDA
- Manual and Automatic ROI
- Sets user-definable protocols for wipes
- Printouts of all data for permanent records with the optional printer
- Direct readouts with spectrum display are in cpm, dpm, curies and becquerels
- Meets all state and NRC wipe test requirements
- USB and RS-232 communication ports for PC and printer
- Compatible with nuclear medicine information management systems via USB
- Built-in database for test and wipe results as well as QC

Well Counters & Radio-TLC

Specifications:**PHYSICAL:****Console Dimensions**

- 9.5" h x 9" w x 10.5" l (42 x 23 x 27 cm)
- Weight: 7.5 lb (3.4 kg)

Well Counter Dimensions

- 9.38" h x 6" dia. (23.8 x 15.2 cm)
- Weight: 15.2 lb (6.9 kg)
- Well Diameter: .67" (1.7 cm)
- Well Depth: 1.5" (3.8 cm)
- Cable Length: 2.7 m (9 ft)

Cables

- Power: 6 ft (1.8 m)
- Printer*: 6 ft (1.8 m)

Performance

- Type: Drilled-well crystal, NaI(Tl) scintillator
- Crystal Dimensions: 1.5" x 1.75" (3.8 x 4.4 cm)
- Shielding: 0.5" lead (1.3 cm)
- Shielding: 9 ft (2.75 m) interconnecting cable
- Channels: 256
- Counting Rate: 100,000 cps, max

Well Detector

- Type: 1 1/2" Sodium Iodide (NaI) drilled-well crystal detector
- 256 Channel MCA, manual and automatic ROI
- Trigger Levels: User-definable
- Automated Calibration and Background Subtract
- QC Tests: Reproducibility, Chi-square, MDA

Display Screen

- Type: 8" VGA LCD color touch screen display
- Bq/Ci Reading: User selectable or fixed
- Activity Display: Selected radionuclide, efficiency, measured activity and display units (Bq/Ci)
- Count Rate Values: Wipe results

Standard Source Data

- System Memory: Cs-137, Eu-152
- Efficiency for commonly used isotopes

PC Port

- Interface: RS-232 and USB
- Compatibility: Standard nuclear medicine management systems

Printer

- RS-232 and USB Ports

Power Requirement

- 100-240 VAC (50/60 Hz) 25 W



5430-0058 Epson Roll Printer

Tests

- Diagnostics: Full test of program, system memories

Cable

- Printer (Optional): 6 ft (1.8 m)
- Power: 6 ft (1.8 m)

*Longer cables are available. Consult factory.



5430-3136 CAPRAC-t Wipe Test/Well Counter

Related:

- 0975-137R** Cs-137 Rod Source
- 0975-152R** Eu-152 Rod Source
- 7900-0352** Protective Screen Covers
- 5430-0058** Epson Roll Printer
- 5420-2141** PET Auxiliary Shield
- 5420-2072** Well Auxiliary Shield, CAPRAC-t, 55TW
- 70670-0016** Test Tubes
- 9282-0009** Roll Paper
- 5420-0121** Well Liners

Well Counters & Radio-TLC

CAP-TLC™ Scanner

Automated TLC strip QC scanner

The Capintec CAP-TLC Scanner is an automated quality assurance tool to rapidly and accurately perform strip QC for any SPECT radiopharmaceutical kit. Dual detector design assures a wide activity range for kits reconstituted any time of the day. The scanner has an optional feeder attachment which holds up to 30 samples. Short scan times assure rapid processing.

The system is compatible with most nuclear pharmacy management systems. Report includes activity distribution graph and Pass/Fail results based on user defined acceptance limits. Automated transfer of data eliminates manual record keeping.

Optional Features

- Bar Code Reader
- Multi Cartridge Feeder
- Collection Tray

Features:

Software

- Windows 10 based application software
- Multiple password security levels
- Manual or bar code assisted job creation
- Daily QC test module
- User definable scan protocols
- Define scan by total counts or time
- Automatically rescans to achieve total counts
- User definable Pass/Fail limits
- Failed results printed in RED
- Includes one strip and two strip protocols
- Supports two or three user defined cut points
- Automatic background subtract
- Excel Report format for easy export
- PC Communication Protocol
- Compatible with most printers

Hardware

- Two collimated GM detectors
- Scanning range 4 μ Ci – 2 mCi
- Scan times typically 1-2 minutes
- Single axis step motor
- Adjustable step points
- Includes QC cartridge
- Custom strip holder cartridge
- Maximum strip length 11.5 cm
- Maximum strip width 2 cm
- Hinged cover provides easy access for cleaning
- USB interface



Specifications:

- Minimum Display Resolution: 1280 x 720 (720 p)
- CPU: x64 processor, 2 GHz or faster
- Operating System: Windows 10
- Minimum Memory: 4 GB
- Minimum Hard Drive: 40 GB
- Microsoft Office or LibreOffice
- Console Dimensions 6.7" h x 8.1" w x 9.6" l (17 x 20.5 x 24 cm)
- Weight: 21.6 lb (9.8 kg)
- Feeder Dimensions: 9.9" h x 5.1" w x 12.1" l (25.1 x 12.9 x 30 cm)
- Weight: 9.0 lb (4.1 kg)
- Working Environment: 0 to 60 °C, 0 to 90% humidity, non-condensing
- Power Requirements: 110-240 VAC 50/60 Hz 50 W



5250-0212 CAP-TLC Scanner
Includes: Console, one QC cartridge and three strip cartridges.

Related:

5250-0213 Auto Feeder
5250-0214 Cartridges 10/pkg
5250-0215 Bar Code Scanner
5250-2110 Collection Tray
0975-0137 Co-57 100 μ Ci QC Source

Well Counters & Radio-TLC

**CAPRAC-t, 55tW Well Auxiliary Shield**

The CAPRAC Wipe Test/Well Counter is a very sensitive system which uses a NaI detector that can be affected by high background activity or changes in the room background during counting periods. If the CAPRAC is used in a location which might have a high background, an Auxiliary Shield can be used to reduce background levels. The Auxiliary Shield walls and top are 0.5" thick. The top lid has a handle for easy removal. The shield fits snugly around the well chamber and can be easily installed or removed.

Specifications:

- Dimensions: 9 3/4" h x 4" w (24.7 x 10.1 cm)
- Weight: 22 lb (10 kg)

**PET Auxiliary Shield**

PET auxiliary shield for the 55tW and CAPRAC-t counter

The Well Auxiliary Shield is made with 1.5" thickness for shielding and sits on its own supporting base. The shield fits snugly around the well chamber for a total of 2" and can be easily installed or removed, as needed.

Specifications:

- Dimensions: 15.625" h x 7.5" w x 6.75" d (39.6 x 19 x 17 cm)
- Weight: 90 lb (40.8 kg)

Well Counters & Radio-TLC



CAPRAC PET Auxiliary Shield

The CAPRAC PET Auxiliary Shield allows for greater shielding of the NaI crystal when higher energy isotopes are being used. This is accomplished by shielding which is 1" thick on the top and walls. The shield fits snugly around the well chamber and can be easily installed or removed.

Specifications:

- Dimensions: 16.625" h x 6.75" w x 8.75" d (42.2 x 17.1 x 22.2 cm)
- Weight: 91 lb (41.2 kg)



CAPRAC Well Liner

The well liner is made of a very thin plastic that is used with the CAPRAC-t Wipe Test/Well Counter.

5420-2137 CAPRAC PET Auxiliary Shield

5420-0121 CAPRAC Well Liner, 5/pkg

Well Counters & Radio-TLC

**CAPRAC Test Tube**

Test tubes are available boxed and oriented in one direction for ease of use. The re-closable box minimizes scratches and damage during storage and protects the unused tubes. Box contains 250 tubes.

Specifications:

- Dimensions: .625" dia. x 2.5" l (1.5 x 6.3 cm)

0670-0016 CAPRAC Test Tube, 250/box

**CAPRAC Test Tube**

Protects against contamination

Test Tube for CAPRAC-T, CRC-25W, CRC-55tW, CAPRAC, CAPRAC-R products. Disposable Plastic Test Tubes.

Features:

- Disposable Plastic Test tubes
- Fits Neatly Into Liner

Specifications:

- Dimensions: .626" dia. x 2.5" l (1.5 x 6.3 cm)

5420-0087 Disposable Test Tube, 100/pkg
Accommodates disposable plastic test tubes with flat bottoms.

Lung Ventilation

Superior Lung Imaging

Xenon or Radioaerosol, it's your choice.

- Pulmonex® II Xenon System
- Xenon Trap Monitor
- Xenon Disposables
- Xenon Convenience Kits
- Xenon Dispenser

- Venti-Scan™ IV Radioaerosol System
- Radioaerosol Convenience Kits
- AeroTech™ I Radioaerosol System



CAPINTEC
A MIRION MEDICAL COMPANY



DELIVERY, DETECTION AND DIAGNOSIS

Lung Ventilation Systems & Accessories

Venti-Scan™ IV

The Venti-Scan IV Radioaerosol Administration System is a self-contained single-use delivery system for Technetium DTPA

Sharp, Clear Images - Easy Breathing

The Venti-Scan IV Radioaerosol Delivery System features a small baffle within the nebulizer to produce an optimal particle size, resulting in a sharp image, quickly. In addition, the kit includes a contoured filter for trapping moisture. This makes it ideal for radioaerosol studies by impeding humidified radiation from passing through. The filter's contour increases surface area to decrease breathing resistance, making it virtually resistance-free with exceptional trapping efficiency.

Designed For Efficiency

The Venti-Scan IV is designed to make performing a study more convenient for the technologist while providing superior images. When the kit is inserted into the Venti-Scan IV canister it automatically locks securely into position, assuring all port alignments. Oxygen connection is a simple attachment to a dedicated external port. The injection site on the kit is precisely angled to align with the canister port. They are positioned perfectly for a bullseye every time. The system also offers a quick, safe disposal method. Unplug the oxygen hose, invert the canister over a shielded waste container and push the release button to free the contaminated kit. This minimizes handling and exposure.

Full Technologist Protection

The Venti-Scan IV shield is completely enclosed providing lead-shielded protection from top to bottom. The Venti-Scan IV Disposable Kit includes everything needed for a single study including a comfortable, natural contour mouthpiece, filter, nose clip and disposal bag. The system uses clean-bore straight path tubing (superior to corrugated) to ensure that particles cannot get trapped in any internal ridges that typically cause clumping. The top of the canister has a shielded sliding port to accommodate the Venti-Pak Accessory Kit for ventilator-assisted patients. An IV pole mount is included with the shield for convenient positioning and administration.

Simple Steps to Perform a Study



Patients and technologists have always been comfortable and confident with the Venti-Scan system. And, when the patient is comfortable, the procedure goes smoothly, without interruption. The end result is a superior study.

Features:

- System design reduces setup time:
 - Kit automatically locks into position
 - One step oxygen connection to dedicated external port
 - Precise injection port alignment
 - Push button disposal of used kit
- Fully enclosed lead shielding from top to bottom
- Contoured filter for increased trapping efficiency and resistance-free breathing
- Trapping efficiency greater than 99.9%
- Small baffle design ensures homogeneous distribution
- Mean particle size = 0.50 microns
- Lightweight and portable, weighs only 8 lb (3.7 kg)

177-090 Venti-Scan IV
Includes: Shielded canister with IV pole mount

Radioaerosol Convenience Kits™

177-091 Convenience Kit, Venti-Scan IV ☉
Includes: 12" (30.5 cm) tubing, small particle delivery system with mouthpiece, filter, nose clip and disposal bag

LATEX FREE

177-092 Convenience Kit, Venti-Scan IV ☉
Includes: 24" (61 cm) tubing, small particle delivery system with mouthpiece, filter, nose clip and disposal bag

LATEX FREE

Note: Each kit is sold in multiples of 10 and 25.

Related:

177-075 Convenience Kit, Venti-Pak for Venti-Scan IV (adapter kit for ventilator assisted patients) ☉
Note: Each kit is sold in multiples of 5.

Lung Ventilation Systems & Accessories

Aerotech™ I Radioaerosol Administration System

The original Cadema Radioaerosol System

Aerosol inhalation for radioimaging studies is an important tool for use in the localization and diagnosis of lung disease. AeroTech I puts information in the hands of the user to assist in diagnosis of a variety of lung diseases.

Enhanced Imaging

The AeroTech I delivers an even distribution of radioaerosol throughout the lungs, reaching the respiratory bronchioles and alveolar ducts and sacs. Excellent aerosol deposition allows the acquisition of multiple views from each diagnostic study. The end result is high quality imaging for confidence in patient diagnosis.

Respirator Compatible

For patients on a respirator, AeroTech I is easily adapted to fit on line using a single accessory tube.

Designed for Patient Comfort

Aerosol inhalation studies allow the patient to breathe normally throughout the procedure, minimizing the likelihood of patient non-compliance.

Superior Safety

Shield construction, disposable components and rapid aerosol delivery time combine to minimize radiation exposure to the patient and technologist. AeroTech I helps meet ALARA radiation protection objectives.

Flexibility

AeroTech I is available with a choice of designs. The 177-324 Delivery System generates a smaller MMAD particle than the standard 177-124 Delivery System. Use the 177-324 model for procedures where delivery time is not significantly restricted.

Features:

- Enhanced Imaging
- Multiple views from one diagnostic study
- Completely portable and respirator compatible
- Completely Shielded

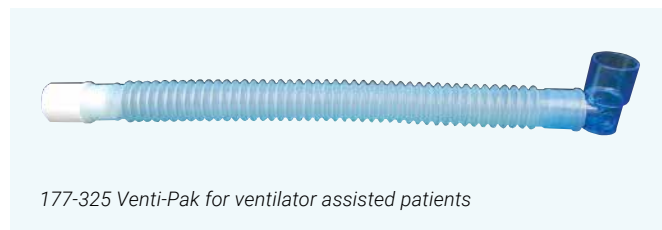

177-325 Venti-Pak for ventilator assisted patients



Shown with kit# 177-124, sold separately.

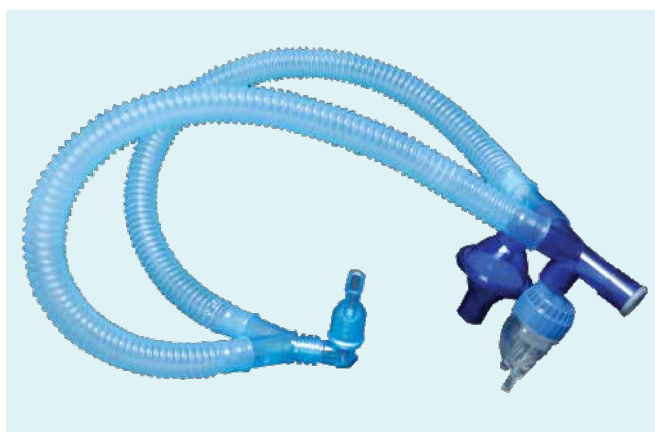

177-095 AeroTech I Shield

Radioaerosol Convenience Kits™

177-124 Convenience Kit, AeroTech I®
LATEX FREE Includes 24" (61 cm) tubing, standard nebulizer delivery system with mouthpiece, bacteria filter, nose clip and disposal bag

177-324 Convenience Kit, AeroTech I with small particle delivery system®
LATEX FREE Includes 24" (61 cm) tubing, small particle nebulizer delivery system with mouthpiece, bacteria filter, nose clip and disposal bag

Note: Each kit is sold in multiples of 5.

Related:

177-325 Convenience Kit, Venti-Pak for AeroTech I, 5/pkg® (adapter kit for ventilator assisted patients)

® Denotes Single Use Only

Lung Ventilation Systems & Accessories

Pulmonex® II Xenon System

The Pulmonex II Xenon System is the best choice for the safe performance of all regional ventilation studies. This is a completely closed system that delivers maximum, reliable results, is simple to operate and reasonably priced.

Resistance-Free Breathing

The injected bolus of xenon will reach the patient exactly when desired. Oxygen may be added to the system any time during the study with the press of a button. An in-line cartridge containing Litholyme absorbs CO₂, preventing acidosis. Large breathing passages, two 10-liter breathing bags (air-in and air-out) and motor-assisted airflow combine to provide resistance-free breathing.

Simple to Operate

All three steps of a Pulmonex II study (start up, equilibrium imaging and washout) are controlled by a single valve handle on the front panel. The valve directs the motor-assisted flow of gases throughout the system. A manually adjusted 15-minute timer initiates all functions, then automatically shuts down the system to complete the study after patient and system washout. With controls conveniently located on the front panel, the user can operate the system and observe the patient and gamma camera from one position. Panel controls are clearly marked for each mode of the procedure with large viewing windows to make it easy to monitor the patient's breathing. The trim, clean design, large handles and total mobility permit easy positioning of the system for studies in both seated and supine positions.

Designed for Safety

Internal systems of the Pulmonex II are shielded for patient and operator safety. The system features two built-in gas traps that operate with a blower fan. Exhaled xenon is pulled through activated charcoal housed within two .125" lead shielded "U"-shaped traps. The double traps extend the life of your charcoal and provide a lengthy migration path for xenon effluent, allowing greater decay and absorption before exhaustion. A cartridge containing Drierite serves as a moisture absorber for air passing into the trap. The charcoal trap can then more effectively remove xenon effluent after each study. Airflow regulation of the trap blowers assure complete patient and system washout. Averaging 30-50 studies per month, the charcoal trap will last approximately one year; charcoal traps are easily replaced. A disposable bacteriostatic filter, used in conjunction with a disposable mask or mouthpiece, prevents system contamination.

Features:

- Resistance-free breathing with 25-liter capacity
- Complete .125" lead shielding in upper cabinet for patient and operator safety
- Easy access to replace Drierite and Litholyme cartridges
- Effortless mobility for easy patient positioning
- Stylish steel cabinet
- Convenient built-in stainless steel tray for holding disposables, xenon gun, syringe, etc.



Specifications:

- Dimensions: 20.5" w x 22" depth x 48.5" h (52.1 x 55.9 x 123.2 cm)
- Motor: UL approved. 12 volt DC
- Electrical Requirements: 115 VAC, 1 amp, 50/60 Hz
- Casters: locking
- Shipping Weight: 375 lb (172.5 kg)
- Certifications: See website for details
- Warranty: One year parts and labor



132-503 Xenon System, Pulmonex II, Double-Trap, 115 VAC
Includes sampling of xenon products.
Currently not for sale in the USA

Related:
136-755 Xenon Trap Monitor
150-315 Dispenser, Xenon, Automatic
130-900 Pulmonex Kit, Free Breathing Hose
132-504 Protective Cover, Pulmonex II

Replacement:
132-319 Charcoal Trap, Pulmonex II
132-555 Cartridge, Refillable, Litholyme or Drierite

Lung Ventilation Systems & Accessories



Automatic Xenon Dispenser

Assures quick, accurate and easy delivery of xenon directly to the patient

The Automatic Xenon Dispenser is easily attached to the front of the Pulmonex System without the use of tools. Preload the xenon vial into the supplied plunger. At the precise moment you want the xenon delivered to the patient, simply press the dispense button.



Xenon Trap Monitor

The Xenon Trap Monitor continuously monitors trap effluent during a xenon study, meeting compliance requirements in most states. An exhaust hose connects from the Pulmonex II exhaust port to the Xenon Trap Monitor's intake port. Counting results are displayed with both audible and visual signals to indicate when the xenon trap exhaust port exceeds of 99 pCi/mL. The unit can also check background levels and perform a self-test for proper operation using a check source. A 10 μ Ci Cs-137 check source is required to calibrate the monitor.

Specifications:

- Dimensions: 7" l x 6" w x 4" h (17.8 x 15.2 x 10.2 cm)
- Lead Shielding: .5" thick (1.3 cm)
- Input: 22 mm Hose Adapter
- Detector: Halogen Quenched GM Tube, 1.1 cm dia., 2 mg/cm² mica window
- Voltage: 500 volts regulated
- Buttons: On/Off, Next/Mute
- Display: 4 Digit LED, 4 RGB Function LEDs (Self Test, Background, Check Source or Count)
- Readings: pCi/ml or counts
- Speaker: Internal, beeps in alarm mode
- Background Count Time: 1 minute
- Power: 18 volts, UL approved, external; 115 VAC power adapter
- Weight: 5.25 lb (11.55 kg)
- Warranty: One year

150-315 Dispenser, Xenon, Automatic
Includes 72" Flexible Tubing with Luer-Lock Adapter

Replacement:
150-317 Tubing, 72" Luer-Lock Adapter, 5/pk

136-755 Monitor, Xenon Trap
Mounts to Pulmonex II Xenon Systems

Related:
101-103 Check Source, Cs-137, 10 μ Ci
Uncalibrated, 1" dia. x .25" thick (2.5 x 64 cm)

Xenon Convenience Kits™

Face Mask or Mouthpiece Kits - Your Choice, Your Convenience.

- Air-Cushioned Face Mask Kits with clear ultra-flex expandable tubing from 6" to 24"
- Mouthpiece Kits with Direct Dose Administration adapter for leak-proof Xenon delivery

Xenon Convenience Kits bring together all the components needed to complete a single xenon study. Xenon can be administered via direct dose administration, that conveniently luer locks without the use of a needle; or by injection port, which requires a syringe needle. Easy to use, simple to order and disposable, Xenon Convenience Kits are more than a bargain, they are a sensible and time-saving investment. In fact, our complete kits can prolong the life of your xenon charcoal traps by ensuring that the pre-filled Drierite cartridges are fresh for every scan while the pre-filled Litholyne (CO₂ absorber) cartridges eliminate possible breakdown of granules that can lead to a clogged system and hinder patient air flow.

For more information, call +1-201-825-9500 or email capintec@mirion.com.

Lung Ventilation Systems & Accessories



**Xenon Convenience Kits
Air-Cushioned Face Mask**



**Xenon Convenience Kits
Air-Cushioned Face Mask
with Injection Port**

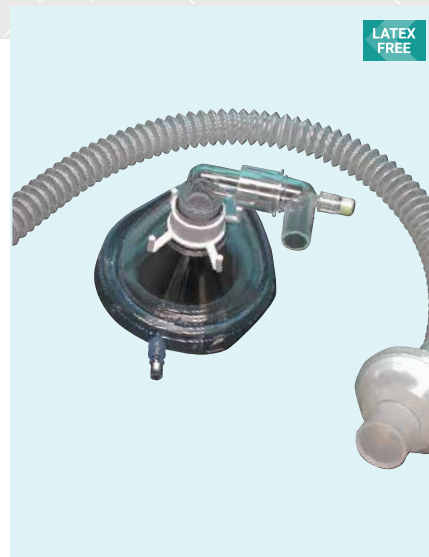

**Xenon Convenience Kits
Air-Cushioned Face Mask
with Luer-Lock Injection Port**

- 132-680** Convenience Kit, Face Mask ☉
Includes: Bacteria filter
- 132-681** Convenience Kit, Face Mask ☉
Includes: Bacteria filter and ultra-flex tubing (shown)
- 132-781** Convenience Kit, Face Mask ☉
Includes: Bacteria filter, ultra-flex tubing, Drierite & Litholyme cartridges
Note: Each kit is sold in multiples of 25.

- 132-690** Convenience Kit, Face Mask with Injection Port ☉
Includes: Bacteria filter (shown)
- 132-691** Convenience Kit, Face Mask with Injection Port ☉
Includes: Bacteria filter and ultra-flex tubing
- 132-784** Convenience Kit, Face Mask with Injection Port ☉
Includes: Bacteria filter, ultra-flex tubing, Drierite & Litholyme cartridges
Note: Each kit is sold in multiples of 25.

- 132-684** Convenience Kit, Face Mask with Luer-Lock Injection Port ☉
Includes: Bacteria filter, ultra-flex tubing and 90° luer-lock injection port
Note: Each kit is sold in multiples of 25.

☉ Denotes Single Use Only

Lung Ventilation Systems & Accessories



Xenon Convenience Kits Air-Cushioned Face Mask w/Direct Dose Administration

No needle necessary



Xenon Convenience Kits with Mouthpiece and Direct Dose Administration Adapter

No needle necessary

- 132-699** Convenience Kit, Face Mask with Direct Dose ☒
Includes: Bacteria filter
 - 132-692** Convenience Kit, Face Mask with Direct Dose ☒
Includes: Bacteria filter and ultra-flex tubing
 - 132-793** Convenience Kit, Face Mask with Direct Dose ☒
Includes: Bacteria filter, ultra-flex tubing, Drierite & Litholyme cartridges
- Note: Each kit is sold in multiples of 25.*

- 132-770** Convenience Kit, Mouthpiece ☒
Includes: Bacteria filter and nose clip
 - 132-774** Convenience Kit, Mouthpiece and Administration Adapter ☒
Includes: Bacteria filter, nose clip and ultra-flex tubing (shown)
 - 132-771** Convenience Kit, Mouthpiece and Administration Adapter ☒
Includes: Bacteria filter, nose clip, ultra-flex tubing, Drierite & Litholyme cartridges
- Note: Each kit is sold in multiples of 25.*

Lung Ventilation Systems & Accessories



Xenon Convenience Kits Air-Cushioned Face Mask and Direct Dose Administration Adapter

No needle necessary



Air-Cushioned Face Mask

The air-cushioned face mask has a pre-filled air-cushion (medium inflation pressure) that molds to the contour of the patient's face providing a tight, leak-proof and comfortable seal. Cushion pressure is easily adjusted by inserting a standard syringe without needle in the two-way valve located on the mask bottom. The flexibility of cushion pressure allows optimum surface contact for every patient. Transparency of the entire mask allows continuous visual identification of patient's vital signs.

134-772 Convenience Kit, Face Mask and Administration Adapter Ⓢ
Includes: Bacteria filter and ultra-flex tubing
Note: Each kit is sold in multiples of 25.

132-685 Face Mask without Injection Port, Adult Ⓢ
Note: Each kit is sold in multiples of 25.

Ⓢ Denotes Single Use Only

Lung Ventilation Systems & Accessories



Air-Cushioned Face Mask with Direct Dose Administration

No needle necessary

In addition to the patient comfort provided by the soft, pliable air cushion of the disposable face mask, the direct dose feature reduces patient anxiety because no needle is used. The syringe luer locks tightly to the direct dose tube, away from the patient's face. The one-way valve prevents the gas from reversing through the mask luer connector, allowing the technologist to disconnect immediately after injecting.

132-698 Face Mask with Direct Dose Administration, Adult ☉

Note: Each kit is sold in multiples of 25.



Air-Cushioned Face Mask with Injection Port

The air-cushioned face mask has a pre-filled air-cushion (medium inflation pressure) that molds to the contour of the patient's face providing a tight, leak-proof and comfortable seal. Cushion pressure is easily adjusted by inserting a standard syringe without needle in the two-way valve located on the mask bottom. The flexibility of cushion pressure allows optimum surface contact for every patient. Transparency of the entire mask allows continuous visual identification of the patient's vital signs. The injection port is attached directly to the face mask and requires a syringe with a needle.

132-695 Face Mask with Injection Port, Adult ☉

Note: Each kit is sold in multiples of 25.

Lung Ventilation Systems & Accessories

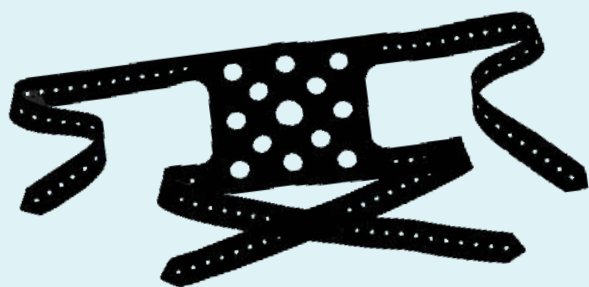

LATEX
FREE

Face Mask Harness

This traditional Face Mask Harness is made of soft rubber and can be adjusted for any head size. The square rubber base is comfortably positioned on the back of the patient's head and the harness tails are brought around to the front. The small holes provide a snug fit on the hook ring, holding the mask firmly in place.



LATEX
FREE

Disposable Nose Clip

Economical, this nose clamp is all plastic for single patient use. Used with any mouthpiece.

139-677 Face Mask Harness

130-100 Nose Clip, Disposable, 100/pkg Ⓢ

Lung Ventilation Systems & Accessories



LATEX FREE

Disposable Bacteria/Viral Filter

Bacteria filters are used to reduce the possibility of cross contamination. The single-use filter is placed in line between a delivery tube and disposable mouthpiece or face mask. Electrostatically charged filter media is 99.9% effective in bacteria/virus retention while maintaining low breathing resistance. Two filters can be piggy-backed together for potential high-risk studies.

132-750 Bacterial/Viral Filter ☉
Note: Each kit is sold in multiples of 25.

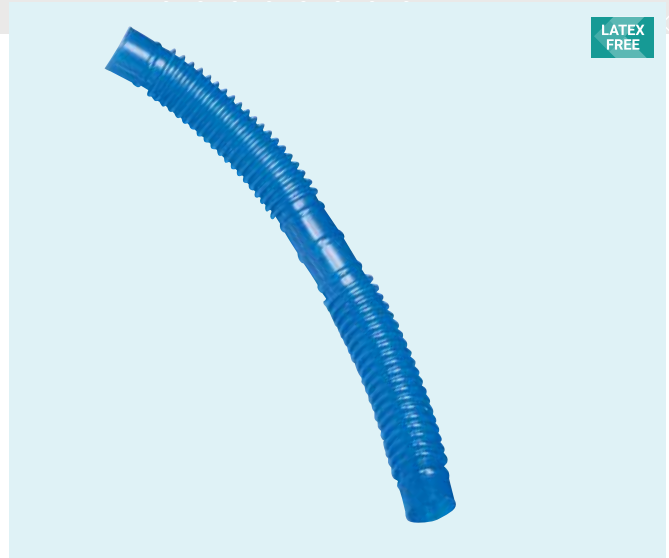

LATEX FREE

Corrugated Tubing

Corrugated Tubing is scored and capped at 6" intervals for easy cutting and firm attachment to fittings.

139-680 Tubing, Corrugated, 100 ft/roll ☉

Lung Ventilation Systems & Accessories



Tubing Splice

Tubing Splice is used to connect sections of 22 mm corrugated tubing to individual mask and filter.



"Y" Connector

The "Y" Connector has a one-way valve and plug. It is used to connect two 22 mm tubes to a mouthpiece, face mask or bacteria filter.

130-639 Tubing Splice, 22 mm Male, 10/pkg ☉

185-302 "Y" Connector, luer plug ☉

139-102 "Y" Connector, solid plug ☉

Note: Not for use with the Pulmonex II

Lung Ventilation Systems & Accessories



Drierite

Moisture absorber - blue and white blend

Drierite serves as a moisture trap for the air going into the charcoal trap of the Pulmonex Xenon System. Drierite is blue and white when dry and turns pink when it has absorbed maximum moisture. Available in two convenient sizes, Drierite is packaged in an air-tight container with a wide-access mouth.



Litholyme

CO₂ absorber

Litholyme, a highly efficient CO₂ absorber, prevents patients from re-breathing carbon dioxide and subsequent acidosis. Available in two convenient sizes, Litholyme is packaged in an air-tight container with a wide-access mouth.

- 139-101** Drierite, 1 lb
- 139-104** Drierite, 4.5 lb
- 132-772** Drierite, Disposable Cartridge 

- 130-019** Litholyme, 1 lb
- 130-020** Litholyme, 4.5 lb
- 132-773** Litholyme, Disposable Cartridge 

 Denotes Single Use Only

Lung Ventilation Systems & Accessories



Free-Breathing Pulmonex Hose Kit

When unrestricted breathing is critical

The Free-Breathing Pulmonex Hose Kit features large bore tubing, which allows for minimal breathing resistance. This inexpensive, high quality, "free breathing" hose kit includes all required components and adapters.

The kit contains two 130-901 "Clean-Bore" hoses (36" l x 1 1/8" dia.), two 130-904 hose clamps, and a 130-902 non-rebreathing anesthesia valve (inlet and outlet 7/8" O.D.), which permits the use of standard disposable bacteria filters and masks while providing unrestricted airway.

130-900 Pulmonex Kit, Free-Breathing Hose

Replacement:

- 130-901** Hose, "Clean-Bore"
36" l x 1.125" dia. (91.4 x 2.9 cm)
- 130-902** Valve, Anesthesia
Hans Rudolph, non-rebreathing
- 130-903** Adapter, Hose
.875" x 1.125" dia. (2.2 x 2.9 cm)
- 130-904** Clamp, Hose



Shown with Air-Cushioned Face Mask with Direct Dose Administration.

Xenon-133 Rebreathing Systems

Disposable pre-packaged kits

A simple, safe and inexpensive method of administering Xenon-133 to perform perfusion steady state and wash out studies. Each kit comes as a complete disposable system, including a pre-filled Litholyne absorber cartridge and a 35-liter bag to ample volume for patient maintenance and collection of expired Xenon-133. Made of a non-permeable plastic, the disposable system precludes xenon absorption or transfer through the device's components. The system is designed to accept any xenon syringe/gun administration system. The entire rebreathing system is disposed of in accordance with NRC regulations.

- 060-133** Xenon-133 Rebreathing System, Mouthpiece ©
Kit includes: Mouthpiece (130-551)
 - 060-137** Xenon-133 Rebreathing System, Mask ©
Kit includes: Air-Cushioned Face Mask with Direct Dose Administration (132-698)
- Note: Each kit is sold in multiples of 5.*

Radiation Detection

Contemporary and User-Friendly

With enhanced features like digital display, ergonomic design, and broader use versatility, these devices are designed to maximize efficiency and accuracy for the modern medical facility and beyond.



CAPINTEC
A MIRION MEDICAL COMPANY

DELIVERY, DETECTION AND DIAGNOSIS

Radiation Monitoring Equipment

RDS-32™ Radiation Survey Meters

The RDS-32 Survey Meters are small handheld, battery operated radiation survey instruments. Due to its versatile functions and durability it is suited for a wide range of applications in civil defense, industrial use, nuclear power plants, laboratories, etc.

The meter features excellent ergonomics; lightweight and easy handling, with visual, audible, and vibration functions. Each meter includes an additional battery cover with belt clip to make it wearable, freeing the user's hands to focus on their primary job.

With both Warning and Alarm levels users can know when they are approaching their limit without constantly monitoring their device and can act accordingly.

To extend the capabilities of the instrument, a wide variety of external Smart probes are available to meet user needs with any RDS-32 version. GMP-12/GMP-25 probes, and the full CSP™ probe range can be connected to all RDS-32 versions with adequate cable. The selection includes probes for gamma and neutron dose rate and alpha and/or beta contamination with various detection areas and scaler counting.

Features:

- H*(10) dose equivalent rate according to latest standards
- External alpha, beta, gamma and neutron probes for direct connection
- RDS-32WR for wider dose rate range
- iTx versions for wireless monitoring
- 4-way navigation keys, practical shortcuts
- Intuitive user interface
- Large graphic screen, configurable backlight
- Automatic display rotation with tilt sensor
- High impact durable case construction, IP67 immersion proof
- Internal memory allows versatile histogram functions and the ability to manually store measurements
- Configuration and firmware upgrade done through the CSW-32™ Software with USB cable-link
- Complies with IEC 60846 standards, designed to meet ANSI 42.17A, 42.17C standards



Specifications:

- Case: high impact durable glass fiber reinforced polymer; Drop tested from 1 m height on concrete floor on each side
- Ergonomic design, rubber grip around the case
- Binder-702 series connector
- Enclosure class IP67 (IEC 60529), including battery compartment
- Dimensions: 116 x 72 x 32 mm (4.57 x 2.83 x 1.26 in)
- Weight without batteries - with batteries
 - RDS-32: 160 g - 210 g (0.35 lb - 0.46 lb)
 - RDS-32iTx: 170 g - 220 g (0.37 lb - 0.49 lb)
 - RDS-32WR: 195 g - 245 g (0.43 lb - 0.54 lb)
 - RDS-32iTxWR: 205 g - 255 g (0.45 lb - 0.56 lb)
- Wrist strap, battery covers with and without a belt clip
- Power supply: Batteries 2 x AA/LR6, alkaline or NiMH
- Operation time with fresh Alkaline batteries more than 2 months 8 h use/24 h (600 h in background radiation, radios disabled, display backlight off, LED off)
- Operation time with fully charged NiMH batteries more than 1.5 month 8 h use/24 h with 2900 mAh capacity (in background radiation, radios disabled, display backlight off, LED off)
- Contacts for external power and charging of NiMH battery
- Alarm audio level 86 dBA at 30 cm
- Operating temperature
 - RDS-32/RDS-32iTx: -25 °C to +60 °C (-13 °F to 140 °F)
 - RDS-32WR/RDS-32iTxWR: -25 °C to +50 °C (-13 °F to 122 °F)
- Storage temperature -40 °C to +70 °C (-40 °F to 158 °F)
- Relative humidity 10% to 95% at +35 °C (95 °F)

Radiation Monitoring Equipment



- RF-immunity: Fulfills following standards: IEC 61000-4-2 (2008), IEC 61000-4-3 (2006 +A1:2007 + A2:2010), IEC 61000-4-6 (2013), IEC 61000-4-8 (2009)
- RF Emissions: Fulfills following standards: EN 55032B
- FCC approval 2AHI8-RDS-32
- IC Approval 26167-RDS32
- IEC 60846-1 (all models), 60846-2 (WR models) compliant
- USB-communication with suitable adapter
- iTx versions: WRM radio 900 MHz or 2.4 GHz
- Maximum possible emitting Tx power:
298 mW at 900 MHz
86 mW at 2.4 GHz

GMP-25™ Pancake Probe

The GMP-25 probe is intended for monitoring alpha, beta, gamma and X-ray radiation. The GMP-25 probe is used as an external detector with the RDS-31/iTx/iTxSD multi-purpose Radiation Survey Meters especially for surface contamination monitoring and source localization applications.

The GMP-25 probe is equipped with a Binder connector and connected to the mating bulk connector interface at the bottom of RDS-31™ family survey meters.

The GMP-25 unit is a "smart" probe, having an internal high voltage generator and non-volatile memory for calibration coefficients and probe identification data. Thus the probe can be connected "on the fly" without the need for switching off the meter, which automatically recognizes the probe type and sets the meter reading to defined measuring unit.

Features:

- Remote pulse rate measurements for alpha/beta/gamma surface contamination measurements
- Converts the meter into contamination monitor
- Sensitive for low levels of alpha, beta and gamma radiation
- For general contamination and frisking applications
- Cord lengths up to 15 meters upon request

5250-1000 Survey Meter, Mirion RDS-32S
5250-1001 Survey Meter, Mirion RDS-32R

5230-0010 Pancake Probe GMP-25
Includes: Fixed coil cable.

Radiation Monitoring Equipment

RDS-80™ Surface Contamination Meter

Allows for easy scanning of surfaces, objects and equipment

The RDS-80 Surface Contamination Meter is a versatile contamination detector which has been designed for a wide range of applications in different fields of radiation protection in the nuclear industry, rescue and other operations, involving a possibility for abnormal contamination levels.

The Digital, Handheld Pulse Rate Meter is suitable for personnel who need to locate and detect contaminated surfaces/objects during their work.

The functions comprise contamination measurements with alarm functions and automatic conversion to surface activity value and additionally surface contamination measurement with a possibility to store the histogram events in the meter's internal memory.

The use of configuration software (RDS-CSW) is required for downloading the data to a PC via IrDA port.

Features:

- Wide measurement range: up to 100 000 cps or 1 000 000 Bq/cm²
- Standard surface contamination measurements in cps or Bq/cm²
- Contamination measurements with histogram function
- Visual and audible alarms
- Handy and easy-to-use design
- Software for parameter setting, histogram readings and nuclide calibration complies with IEC 60325 standard

Specifications:

- Dimensions: 3.07" x 4.96" x 2.24" (7.8 x 12.6 x 5.7 cm)
- Weight:
 - .6172 lb (.28 kg) without batteries
 - .7275 lb (.33 kg) with batteries
- Case: Rugged plastic case
- GM Tube: 1.74" dia. (4.4 cm)
- Power Supply: 2 alkaline batteries IEC LR6/AA size (recommended)
- Battery Life Time: At least 2000 hours at normal background with alkaline cells (more than 1 year under normal operation)
- Battery Alarm: Two-step alarm for low battery voltage

Characteristics:

- Radiation Detected: Alpha >2 MeV, beta E_{max} >100 keV, gamma and X-rays from 5 keV to 3 MeV
- Detector: End window GM tube, 1.5-2 mg/cm²
- MICA Window: Active surface area 15.2 cm²



- Measurement Range: Surface contamination 1 to 100 000 cps or 0.01 to 1 000 000 Bq/cm²
- Alarm levels: Freely adjustable alarm levels for contamination level
- Cps linearity: ±15% ±1 digit over the range. The Bq/cm² display is calculated from cps values using isotope dependent coefficients
- Display: Either cps or Bq/cm²
- Surface Activity: (Bq/cm²) display configurable for different isotopes
- Cps Rate: Follow-up by audible signal with frequency proportional to activity
- Visual and Audible Alarm: User settable for surface activity
- Histogram Capability: Up to 480 points with user settable logging interval
- Backlit Display: Six large digits
- Built-in Self-diagnostics Function
- Gamma Background: Reduction for Bq/cm² measurements
- Built-in Infrared port (IrDA)

5250-0256 Surface Contamination Monitor, RDS-80

DELIVERY, DETECTION AND DIAGNOSIS

Positioning Devices

Scan-Track™ External System with Scan-Bands® Set

A heavy duty track system that connects to the cradle under your systems table pad. This gives your patients a much more comfortable, safe and secure imaging experience. Straps are easily attached and help keep your patients still during imaging, providing clearer images and quicker scanning. The system includes the heavy duty track system, scan-bands and the accompanying corded straps.

Features:

- Helps reduce patient fall risk
- Helps reduce health care-associated infections
- Helps reduce motion artifacts
- Antimicrobial, stain resistant comfort nylon material
- Channel installs onto the imaging table, allowing Patient Support Straps to easily attach and slide along the length of the track
- Provides uninterrupted travel down the length of the scanner
- Fast positioning and superior patient support
- Increases technologists' positioning capabilities
- Optimizes patient positioning to improve comfort during immobilization
- Ideal for accommodating different studies
- Utilizes the otherwise idle space along the outer edge of the scanner
- 72" long track system
- Attach to the table and/or table pad's existing hook or loop adhesive tape



- 0652-0061** Scan-Track Antimicrobial Scan-Bands
*72" Track with 15" w x 32" l and 15" w x 23" l
left and right straps with hook and loop*
- 0625-0011** Scan-Bands 2 Band Set
with Cording Attachment
4" w x 22" l and 4" w x 20" l
- 0625-0012** Scan-Bands 2 Band Set
with Cording Attachment
6" w x 32" l and 6" w x 23" l
- 0625-0013** Scan-Bands 2 Band Set
with Cording Attachment
6" w x 38" l and 6" w x 23" l
- 0625-0014** Scan-Bands 2 Band Set
with Cording Attachment
9" w x 32" l and 9" w x 23" l
- 0625-0015** Scan-Bands 2 Band Set
with Cording Attachment
9" w x 38" l and 9" w x 23" l
- 0625-0016** Scan-Bands 2 Band Set
with Cording Attachment
15" w x 32" l and 15" w x 23" l
- 0625-0017** Scan-Bands 2 Band Set
with Cording Attachment
15" w x 38" l and 15" w x 23" l
- 0625-0018** Scan-Bands 2 Band Set
with Cording Attachment
24" w x 32" l and 24" w x 23" l
- 0625-0019** Scan-Bands 2 Band Set
with Cording Attachment
24" w x 38" l and 24" w x 23" l

Positioning Devices

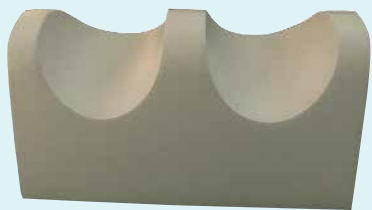

Leg Rest

Contoured Leg Rests come in three sizes. These unique leg rests help with comfort and support which minimizes body motion.

Specifications:

0652-0037 Small Leg Support

- Dimensions: 18" w x 14" d x 5" h (45.72 x 35.56 x 12.7 cm)

0652-0040 Medium Leg Support

- Dimensions: 18" w x 17" d x 7" h (45.72 x 43.2 x 17.78 cm)

0652-0041 Large Leg Support

- Dimensions: 24" d x 18" w x 10" h (60.96 x 45.72 x 25.4 cm)

0652-0037 Small, Leg Rest
0652-0040 Medium, Leg Rest
0652-0041 Large, Leg Rest

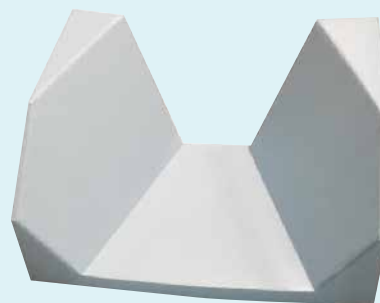

Patient Arm Support

Head/Arm Supports are designed to safely fit the multi-head imaging and diagnostic cameras. They can accommodate any patients with its soft, yet durable coating. They are easily cleaned.

Specifications:

- Dimensions: 9" h x 20" w x 8" d (22.86 x 50.8 x 20.32 cm)

0652-0038 Patient Arm Support II, Antimic

Positioning Devices



Universal Straps

Features:

- Strap fastens around patient, table or both simultaneously
- Velcro closures allow easy, fast attachment back onto itself
- Multiple sizes available
- Customized for your departmental needs

- 0652-0057** Universal Strap
Used for SPECT or PET Imaging
- 0652-0058** Universal Strap
Set Includes: 2 sets of 30" tracks for above cut out and below (left & right) and 2 sets of straps 9" w x 23" l and 9" w x 32" l
- 0625-0003** Universal Body Strap
12" w x 60" l (30.5 x 152.4 cm) Black Nylon

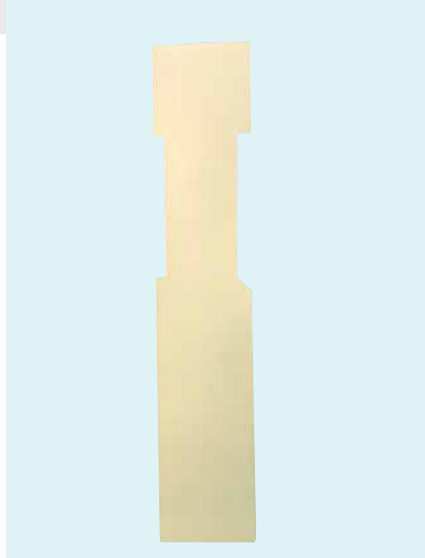

Cardio MD Table Pads

Anti-microbial health care covering

The Cardio MD Table Pads sit on standard hospital bed platforms or patient stretchers. The pull-out section creates space so the technician can manipulate the transducer for optimum visualization.

Replacement Table pads for most cameras.

- Quality replacement Table Pads
- Anti-Microbial health care covering
- Spray on coating
- Custom branding
- Choice of foam
- Custom designs

Color options available:

- Black
- Deep Blue
- Medical Blue
- Light Blue
- Gray

- 0652-0043** Cardio MD Table Pad, Long



Table Pad

We provide table pads to fit all OEM tables.

Specifications:

0652-0046 E-Cam Table Pad

- Dimensions: 83" l x 15" w x 1" d (210.8 x 38.1 x 2.5 cm)

0652-0047 Infinia Antimicrobial Table Pad

- Dimensions: 78" l x 14" w x 1" d (198.1 x 35.5 x 2.5 cm)

- 0652-0046** E-Cam Table Pad
- 0652-0047** Infinia Antimicrobial Table Pad, without strap

DELIVERY, DETECTION AND DIAGNOSIS

Dispensing Systems



for
PET

12 Station Automatic Vial Dispenser

Ideal system for daily production in a cGMP facility

The 12 Station Automatic Vial Dispenser is a fully automated system for dispensing multiple vials with different doses in a continuous process. The rubber stopper is removed, the vial is filled with a radiopharmaceutical to the correct dose level, the rubber stopper is replaced, the aluminum cap is sealed, the bar code is applied, and the vial is returned to the transport container without interruption. The unit is able to dispense twelve different isotopes, including, F-18, Gu-64, Ni-63, I-131, and Tl-201. This dispenser is an ideal system for daily production in a cGMP facility.

Features:

- A rotating carriage delivers twelve 10 ml vials into position for processing
- A moveable suction device removes the rubber stopper
- A clamp both removes and replaces the aluminum cap
- A rotating arm moves the dispensing needle into position
- Software controls the process of dispensing the unit dose, dose dilution, and calculating dose decay time corrections
- A dose calibrator measures the activity in each vial
- A capping device seals the aluminum cap
- A bar code scanner identifies the dose prescription
- A moveable clamp delivers the filled vial to the transport carriage

Specifications:

- Model: MDV-12
- Dispensing time: Average 70 second per vial (15 minutes for 12 vials)
- Dimensions: 21" w x 19.5" d x 13" h (54 x 50 x 34 cm)
- Weight: 88 lb (40 kg)
- Power: 110 voltage, 1 phase, 10 Amp
- Pneumatic pressure: 6 bar

0670-20002 12 Station Automatic Vial Dispenser



for
PET

Multiple Automatic Dose Dispenser

This dispenser allows the pharmacist to compound and dispense radiopharmaceuticals from three individual shielded vials into a unit dose syringe. It is ideal for routine dispensing of various radiopharmaceuticals.

Features:

- A rotating vial holder for loading three vials with a gas vent filter is included. Desired doses are input and the selected vial rotates to the upright position of the shielded syringe platform to introduce the syringe needle to draw the dose
- The shielded syringe platform has two operation platforms. One platform is for rotating the syringe to the desired vial position, another platform has two actuators to introduce the syringe needle and to draw the plunger
- An automatic needle decapper is equipped to remove and recap the needle during the procedure
- Easy to place various drugs in the vial holders for unit dose drawing
- All the procedures are controlled by PC programming software
- This provides the ability to easily set dose volumes, decay time corrections, various compounding factors, and manage the database
- Dispensing a dose can be completed within 40 seconds
- There are three shielded vial holders to load the various radiopharmaceuticals. Each vial holder utilizes tungsten vial shields for PET or lead glass vial shields for SPECT doses 10 to 30 m vials can be accommodated
- The 9 mm tungsten syringe shielding with LED illumination provides radiation shielding and the clear view of the dose volume during procedures

Specifications:

- Dimensions: 11.8" w x 11.8" d x 3.5" h (30 x 30 x 39 cm)
- Weight: 66 lb (30 kg)
- Power: 110 to 220 VAC 5 A, 50/60 Hz
- Gas Power: 4 to 6 Bars
- Pneumatic Pressure: 6 bar

0670-0029 Multiple Automatic Dose Dispenser

Dispensing Systems



ADG 2000™ Automatic Syringe Dispenser

These Automatic Dispensing Systems are stand-alone modular devices with three components. These components are the pump and valve control unit, the mechanical control units, and the operating software. The automated functions include activity concentration, measurement and calculation, decay time correction, saline dilution, gas extraction, and patient data management.

Features:

- Dose measurement, decay correction, saline dilution, and gas extraction are achieved in one continuous step
- The accuracy of both systems is within 5% for total activity and within 5% for volume (less than 0.01 ml)
- The systems can manage activity levels up to 2000 mCi at a concentration of 130 mCi/ml
- Less than 30 seconds is required for dispensing, dilution and gas extraction

The operating software serves two main functions
Radiopharmacy Function:

- Selects up to 12 nuclides for dispensing
- Enables either one or two dose calibrators to measure activity in the mother vial and activity in the daughter syringe
- Performs decay time correction and activity calculation for both the mother vial and the daughter syringe dose.
- Performs volume calibration and activity concentration measurement for daily QC
- Label printer control mode can select a specific printer

Patient Management Function:

- Patient data includes date, injection time, required dose, dispensing dose, ID number, weight, and DOB
- Residual activity in empty syringe
- Remote display in PET injection room
- Patient history data base
- Electronically recorded and signed

0670-0025 ADG 2000 Automatic Syringe Dispenser



ADG 500™ Vial and Syringe Dispenser

These Automatic Dispensing Systems are stand-alone modular devices with three components. These components are the pump and valve control unit, the mechanical control units, and the operating software. The automated functions include activity concentration, measurement and calculation, decay time correction, saline dilution, gas extraction, and patient data management.

Features:

- Dose measurement, decay correction, saline dilution, and gas extraction are achieved in one continuous step
- The accuracy of both systems is within 5% for total activity and within 5% for volume (less than 0.01 ml)
- The systems can manage activity levels up to 2000 mCi at a concentration of 130 mCi/ml
- Less than 30 seconds is required for dispensing, dilution and gas extraction

The operating software serves two main functions.
Radiopharmacy function:

- Selects up to 12 nuclides for dispensing
- Enables either one or two dose calibrators to measure activity in the mother vial and activity in the daughter syringe
- Performs decay time correction and activity calculation for both the mother vial and the daughter syringe dose
- Performs volume calibration and activity concentration measurement for daily QC
- Label printer control mode can select a specific printer

Patient Management function:

- Patient data includes date, injection time, required dose, dispensing dose, ID number, weight, and DOB
- Residual activity in empty syringe
- Remote display in PET injection room
- Patient history data base
- Electronically recorded and signed

0670-0026 ADG 500 Vial and Syringe Dispenser

Syringe Shields

Expertly Designed for Safer Handling

To significantly reduce hand exposure from radiopharmaceuticals during injections, tungsten and lead glass Syringe Shields are engineered for optimal protection and convenience.

- Tungsten Syringe Shields
- Lead Glass Syringe Shields
- PET Syringe Shields
- Beta Syringe Shields
- Carriers and Holders for Safe Handling
- Injection and Disposal Supplies



CAPINTEC
A MIRION MEDICAL COMPANY

LAB SUPPLIES

Shielding & Storage



Pro-Tec™ II Syringe Shield

Thin, lightweight and easy to use, the Pro-Tec II is designed to reduce hand exposure for clinicians during preparation and administration of radiopharmaceuticals.

The barrel of the shield is constructed of 2 mm thick tungsten that will reduce radiation exposure from Tc-99m by more than 99% attenuation for Tc-99 tested with TLD chips. A 5.05 density lead glass window provides protection and visibility. A white reflective surface on the shield interior improves viewing of the syringe's markings and fluid content. Polymer encasement and beveled edge around the lead glass helps guard against scratching or breaking. A thumbscrew holds syringes firmly in place. Pro-Tec II Syringe Shields accommodate the standard sized 3 cc and 5 cc syringes.

Features:

- 2 mm thick tungsten shielding
- 5.05 density lead glass window
- Lightweight
- Fits most disposable syringes
- Unobstructed visibility to tip of syringe
- Replacing scratched or broken glass is simple – no gluing required
- Easily sanitized with alcohol wipes

Pro-Tec II Syringe Shields with lead glass window:

007-800 Syringe Shield, 3 cc
007-900 Syringe Shield, 5 cc
 U.S. Patent #4,062,353

Pro-Tec II Syringe Shields without lead glass window:

007-801 Syringe Shield, 3 cc
007-901 Syringe Shield, 5 cc

Replacement:

127-735 Syringe Shield Replacement Glass, 3 cc and 5 cc
007-803 Syringe Shield Replacement Screws, 15 pkg

Replacement glass for previous generation Pro-Tec II Syringe Shields with clip: www.capintec.com



Pro-Tec™ III Syringe Shield

The Pro-Tec III Syringe Shield is designed to reduce hand exposure in clinicians preparing and administering radiopharmaceuticals. With its lightweight, sleek design, this syringe shield is easy to use.

The barrel of the shield is constructed of 2 mm thick tungsten that will reduce radiation exposure from Tc-99m by more than 99% attenuation for Tc-99 tested with TLD chips. A 5.05 density lead glass window provides protection and optimal visibility. A white reflective surface on the shield interior improves viewing of the syringe's markings and fluid content. Polymer encasement and beveled edge around the lead glass helps guard against scratching or breaking. The quick release, Safe-T-Lock is designed to facilitate minimal handling, thereby reducing hand exposure. Upon insertion, the Safe-T-Lock grips and securely locks the syringe into place. Disposing of used syringes is easy; invert the syringe shield over a sharps container, press the release button and the syringe freely disengages.

Features:

- 2 mm thick tungsten shielding
- 5.05 density lead glass window
- Safe-T-Lock firmly secures syringe to avoid rotating
- Safe-T-Lock design reduces exposure with faster handling
- Unobstructed visibility to tip of syringe
- Replacing scratched or broken glass is simple – no gluing required
- Easily sanitized with alcohol wipes

Pro-Tec III Syringe Shields:

007-723 Syringe Shield, 1 cc (BD luer lock)
007-734 Syringe Shield, 1 cc (press fit)
007-755 Syringe Shield, 2.5 cc (HSW)
007-735 Syringe Shield, 3 cc
007-736 Syringe Shield, 5 cc
007-738 Syringe Shield, 10 cc

Replacement:

127-734 Syringe Shield Replacement Glass, 1 cc
127-735 Syringe Shield Replacement Glass, 3 cc and 5 cc
127-738 Syringe Shield Replacement Glass, 10 cc

Shielding & Storage

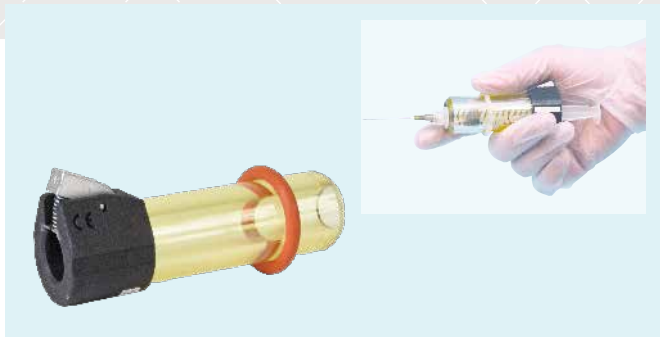

Pro-Tec™ IV Syringe Shield

Convenient to use, the Pro-Tec IV Syringe Shield reduces hand exposure and maximizes the viewing area.

The barrel of the shield is constructed of optically clear, 5.6 high density lead glass. The 360° view and a tapered end on the lead glass barrel provide complete visibility of the syringe contents, allowing for faster and easier venipuncture. The high density lead glass significantly reduces radiation exposure from Tc-99m by more than 99% attenuation for Tc-99m tested with TLD chips.

The Safe-T-Lock is designed to facilitate minimal handling, reducing hand exposure. Upon insertion, the Safe-T-Lock grips and securely locks the syringe into place. Disposing used syringes is easy; invert the syringe shield over a sharps container, press the release button and the syringe freely disengages.

Features:

- 5.6 High density lead glass shielding; 360-degree barrel view
- Lightweight
- Fits most disposable syringes
- Safe-T-Lock design reduces exposure with faster handling
- 5 cc syringe shield – ideal for Quadramet®
- Easily sanitized with alcohol wipes

Pro-Tec IV Syringe Shields:

007-670	Syringe Shield, 1 cc
007-675	Syringe Shield, 3 cc
007-680	Syringe Shield, 5 cc
007-685	Syringe Shield, 10 cc



Beta Syringe Shield

This Beta Syringe Shield reduces hand exposure from syringes containing beta-emitting radiopharmaceuticals such as those used in Theranostics and Therapeutics. The barrel of the syringe shield is constructed of clear plastic, which attenuates Beta emission. The .062" thick embedded lead lining attenuates Gamma emission and errant bremsstrahlung. The viewing window provides clear visibility when drawing and administering a dose. A thumbscrew holds syringes firmly in place.

Features:

- Lead and plastic shielding, designed for Beta
- Clear plastic window
- Fits most disposable syringes
- Suitable for alpha emitting therapy agents
- 20 cc syringe shield – ideal for theranostics

Specifications:

007-956 Beta Syringe Shield, 1 cc

- Dimensions:
O.D.: 1.63" dia. x 3.25" l (4.1 x 8.3 cm)
I.D.: 0.41" dia. (1 cm)
- Shielding: .062" thick (.16 cm) lead
- Weight: 10.4 oz. (297 g)

007-957 Beta Syringe Shield, 10 cc

- Dimensions:
O.D.: 1.625" dia. x 3.25" l (4.1 x 8.3 cm)
I.D.: 0.750" dia. (1.9 cm)
- Shielding: .062" thick (.16 cm) lead
- Weight: 9.6 oz (274 g)

007-958 Beta Syringe Shield, 20 cc

- Dimensions:
O.D.: 1.88" dia. X 3.75" l (4.7 x 9.5 cm)
I.D.: .96" (2.44 cm)
- Shielding: .062" thick (.16 cm) lead
- Weight: 11.2 oz (318 g)

007-956	Syringe Shield, Beta, 1 cc
007-957	Syringe Shield, Beta, 10 cc
007-958	Syringe Shield, Beta, 20 cc

Shielding & Storage



Dose Drawing Syringe Shield (glass non-replaceable)



Dose Drawing Syringe Shield with replaceable glass



Dose Drawing Syringe Shield

Lightweight, easy-to-use design

These Syringe Shields reduce hand exposure when drawing doses from a shielded vial. Constructed of optically clear high density lead glass, the barrel of the syringe shield offers complete 360° visibility while reducing radiation exposure from Tc-99m by more than 99%. The shield features quick and smooth syringe insertion with an O-ring seal and anti-roll cap. Constructed with a polymer material on each end that acts as a shock absorber.

Dose Drawing Syringe Shields:

Accommodates luer and non-luer lock syringes

007-661 Syringe Shield, 3 cc

007-663 Syringe Shield, 5 cc and 6 cc

007-665 Syringe Shield, 10 cc and 12 cc

Dose Drawing Syringe Shields with Replaceable Glass:

Accommodates luer and non-luer lock syringes

007-691 Syringe Shield, 3 cc

007-693 Syringe Shield, 5 cc and 6 cc

007-695 Syringe Shield, 10 cc and 12 cc

Replacement:

127-691 Syringe Shield Replacement Glass, 3 cc

127-693 Syringe Shield Replacement Glass, 5 cc and 6 cc

127-695 Syringe Shield Replacement Glass, 10 cc and 12 cc

511 Dose Drawing Syringe Shield

Constructed with the same featured shielding as the 511 C-Tec Syringe Shields

The 511 Dose Drawing Syringe Shields are constructed with the same featured shielding as the 511 C-Tec Syringe Shields. The needle end of the syringe shield has a tungsten disc that protects the user's hands during the dose drawing procedure.

There are 2 pins in the end disc that secure the shield to the Drawing Station. This allows single-handed dose removal from the drawing station. The syringe shield has a tungsten thickness of .315".

0665-2017 511 Dose Drawing Syringe Shield 5cc

High Density Lead Glass Syringe Shield

The High Density Lead Glass Syringe Shield reduces hand exposure from Tc-99m by more than 99% and allows a large viewing area and is easy to use. The barrel of the syringe shield is constructed of optically clear high density (5.6) lead glass and offers complete 360° visibility. The end of the barrel is tipped with a polymer material to protect it from breaking or scratching. This lightweight shield features quick and smooth syringe insertion with an O-ring seal and an anti-roll cap.

Features:

- Lead glass provides clear visibility
- Accommodates most vials
- Centering action holds vials securely

High Density Lead Glass Syringe Shields:

Accommodates luer and non-luer lock syringes

007-620 Syringe Shield, 1 cc

007-635 Syringe Shield, 3 cc

007-652 Syringe Shield, 5 cc and 6 cc

007-612 Syringe Shield, 10 cc and 12 cc

Shielding & Storage



Twist to lock syringe in place with one hand

Gaard Lock™ PET Syringe Shield

The Gaard Lock PET Syringe Shield reduces hand exposure from syringes containing 511 keV radionuclides FDG F-18. The syringe shield is offered with or without a high density (5.6) flush mounted lead glass window that provides protection and visibility. A white reflective surface on the shield interior improves viewing of the syringe's markings and fluid content.

Features:

- Unique flange locking design reduces exposure with faster handling
- Constructed of .34" thick tungsten, attenuates FDG F-18 by 88%
- Available with or without a high density lead glass window
- Easily sanitized with alcohol wipes

Specifications:

- Shielding: .34" tungsten (9 mm)
- Lead Glass: 5.6 density

007-711 & 007-716 Gaard Lock Syringe Shield, 3 cc

- Dimensions: 2.9" l (74 mm)
- Weight: 1.7 lb (.77 kg)

007-712 & 007-717 Gaard Lock Syringe Shield, 5 cc

- Dimensions: 3" l (76 mm)
- Weight: 2 lb (.91 kg)

007-713 & 007-718 Gaard Lock Syringe Shield, 10 cc

- Dimensions: 3.6" l (91 mm)
- Weight: 3 lb (1.4 kg)

Gaard Lock PET Syringe Shields with lead glass window:

- 007-716** Syringe Shield, 3 cc
- 007-717** Syringe Shield, 5 cc
- 007-718** Syringe Shield, 10 cc

Gaard Lock PET Syringe Shields without lead glass window:

- 007-711** Syringe Shield, 3 cc
- 007-712** Syringe Shield, 5 cc
- 007-713** Syringe Shield, 10 cc

Replacement:

- 007-974** Glass, Replacement
For 007-716, 007-717, 007-718, 007-961, 007-962, 007-969, 007-973, 007-975 and, 007-980.



Z-PET Syringe Shield

The Z-PET Syringe Shield greatly reduces hand exposure from syringes containing 511 keV radionuclides. The barrel of the shield is constructed of .55" thick tungsten that attenuates FDG F-18 by 97%. The shield accommodates standard 5 cc syringes.

Features:

- Extra thick wall for extra protection
- Constructed of .55" thick tungsten, attenuates FDG F-18 by 97%
- Easily sanitized with alcohol wipes

Specifications:

- Dimensions: 2.75" l x 1.7" dia. (7 x 4.3 cm)
- Shielding: .55" thick (14 mm) tungsten
- Weight: 3.7 lb (1.7 kg)

- 007-945** Syringe Shield, Z-PET, 5 cc*

*Z-PET Syringe Shield was conceived by Michael Zimmer, Ph.D.

Shielding & Storage

Pro-Tec™ PET Syringe Shield

The Pro-Tec PET Syringe Shield reduces hand exposure from syringes containing 511 keV radionuclides. The syringe shield is offered with or without a high density (5.6) flush mounted lead glass window that provides protection and visibility. A white reflective surface on the shield interior improves viewing of the syringe's markings and fluid content. A thumbscrew holds syringes firmly in place.

Features:

- 3/4" thick tungsten attenuates FDG F-18 by 88%
- Available with or without a high density lead glass window
- Fits most disposable syringes
- Easily sanitized with alcohol wipes

Specifications:

007-973 Syringe Shield, 3 cc

- Dimensions:
O.D.: 1.160" (2.945 cm)
I.D.: .480" (1.21 cm)
Length: 2.75" (6.98 cm)

007-969 Syringe Shield, 5 cc HSW

- Dimensions:
O.D.: 1.280" (711 cm)
I.D.: .600" (1.52 cm)
Length: 2.5" (6.35 cm)

007-975 Syringe Shield, 5 cc

- Dimensions:
O.D.: 1.280" (711 cm)
I.D.: .600" (1.52 cm)
Length: 2.75" (6.98 cm)

007-980 Syringe Shield, 10 cc

- Dimensions:
O.D.: 1.440" (3.65 cm)
I.D.: .760" (1.93 cm)
Length: 3.280" (8.33 cm)

- Shielding: .34" thick (9 mm) tungsten

- Lead Glass: 5.6 density

- Weight:

007-973 & 007-985: 1.4 lb (.64 kg)

007-969, 007-975 & 007-990: 1.7 lb (.77 kg)

007-980 & 007-995: 2.3 lb (1.05 kg)

007-983 Syringe Shield, 1 cc

- Dimensions:
O.D.: 1.160" (2.945 cm)
I.D.: .406" (1.03 cm)
Length: 3.00" (7.62 cm)

007-985 Syringe Shield, 3 cc

- Dimensions:
O.D.: 1.160" (2.945 cm)
I.D.: .480" (1.21 cm)
Length: 2.75" (6.98 cm)

007-990 Syringe Shield, 5 cc

- Dimensions:
O.D.: 1.280" (711 cm)
I.D.: .600" (1.52 cm)
Length: 2.75" (6.98 cm)

007-995 Syringe Shield, 10 cc

- Dimensions:
O.D.: 1.440" (3.65 cm)
I.D.: .760" (1.93 cm)
Length: 3.280" (8.33 cm)

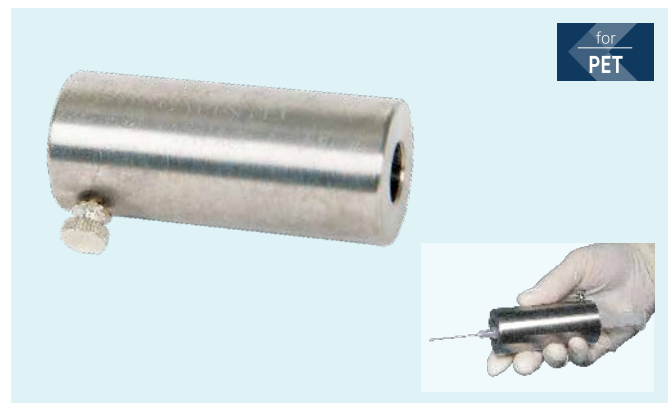

Pro-Tec PET Syringe Shields with lead glass window:

- 007-973** Syringe Shield, 3 cc
- 007-969** Syringe Shield, 5 cc HSW
- 007-975** Syringe Shield, 5 cc
- 007-980** Syringe Shield, 10 cc

Pro-Tec PET Syringe Shields without lead glass window:

- 007-983** Syringe Shield, 1 cc
- 007-985** Syringe Shield, 3 cc
- 007-990** Syringe Shield, 5 cc
- 007-995** Syringe Shield, 10 cc

Replacement:

- 007-974** Glass, Replacement
For 007-716, 007-717, 007-718, 007-961, 007-962, 007-969, 007-973, 007-975 and 007-980.
- 007-968** Syringe Shield Replacement Screws, 15 pkg

Note: Syringe Shields available for a selection of international syringes. Contact Capintec at +1-201-825-9500 or e-mail capintec@mirion.com.

Shielding & Storage

Pro-Tec™ PET/MR Syringe Shield

This non-magnetic, Pro-Tec PET/MR Syringe Shield reduces hand exposure from syringes containing 511 keV radionuclides. The barrel of the shield is constructed of .34" thick tungsten, which attenuates FDG F-18 by 88%. The shield is clearly labeled and engraved as MR safe to avoid confusion.

A 5.6 high density, flush-mounted, lead-glass window provides additional protection and optimal visibility. A white reflective surface on the shield interior improves viewing of the syringe's markings and fluid content. A thumbscrew holds syringes firmly in place.

Pro-Tec PET/MR Syringe Shields accommodate the standard sized 3 cc and 5 cc syringes.

Features:

- MR Conditional for 3T
- Ideal for the administration of high-energy isotopes for PET/MR imaging
- Constructed of .34" thick tungsten; attenuates FDG F-18 by 88%
- Easily sanitized with alcohol wipes

Specifications:

- Shielding: .34" thick (9 mm) tungsten
- Lead Glass: 5.6 density



Pro-Tec PET/MR Syringe Shields with lead glass window:

- 007-961** Syringe Shield, 3 cc
- 007-962** Syringe Shield, 5 cc

Pro-Tec PET/MR Syringe Shields without lead glass window:

- 007-966** Syringe Shield, 3 cc
- 007-967** Syringe Shield, 5 cc

Replacement:

- 007-974** Glass, Replacement
For 007-716, 007-717, 007-718, 007-961, 007-962, 007-969, 007-973, 007-975 and, 007-980.
- 007-968** Syringe Shield Replacement Screws, 15 pkg

Shielding & Storage

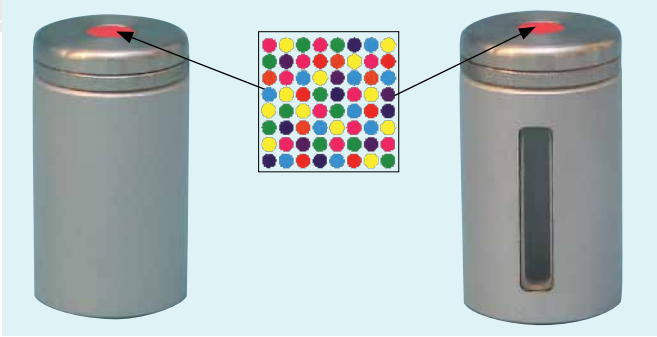

Lead Vial Shield with Magnetic Cap

Color coding for easy identification

Designed to facilitate quick and easy access, the Lead Vial Shield features a tungsten screw top with a magnetic cap. For easy identification, a recessed hole is located on the top of the cap to accommodate a colored label.

The body of the vial shield is machined with 0.31" thick lead, accommodating most 10 ml vials.

A 4.2 density lead glass window provides protection and visibility.

Features:

- Magnetic cap designed to facilitate minimal handling
- .31" lead shielding
- Virtually unbreakable tungsten top
- Available with or without glass window
- Includes multi-colored labels for easy identification

Specifications:

- Dimensions:
O.D.: 1.7" dia. x 3.0" h (4.3 x 7.6 cm)
I.D.: 1.05" dia. x 2.24" h (2.7 x 5.7 cm)
- Lead Shielding: 0.31" thick (.79 cm)
- Lead Equivalency: 0.286" thick lead for Tc-99m
- Accommodates Vial Size: 10 ml
- Weight: 2.2 lb (1 kg)

053-610	Vial Shield, 0.31" lead, Magnetic Cap <i>Includes a sheet of colored labels</i>
053-611	Vial Shield, 0.31" lead, Magnetic Cap, with glass <i>Includes a sheet of colored labels</i>

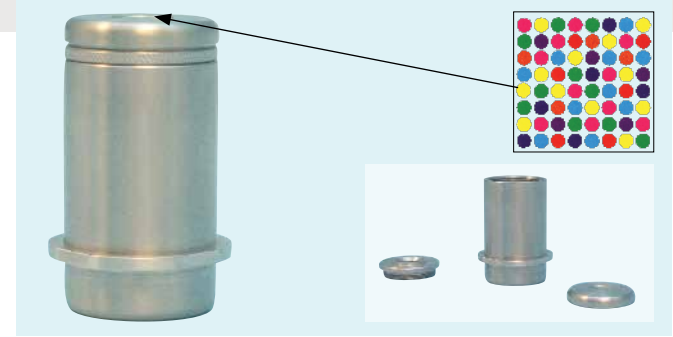

Tungsten Lead Vial Shield with Magnetic Cap

Designed with holding ring for hand ergonomics or inverted placement in dispensing station.

Designed for vials containing liquid radioisotopes, the Tungsten Vial Shield features a removable screw top with a magnetic cap. Speed of handling reduces exposure. Another design feature is the holding ring which fits comfortably in the hand or into a dispensing stand. The magnetic cap holds the lid in place even when inverted on the stand.

Machined with 0.2" thick tungsten, the vial shield accommodates most 10 ml vials.

Features:

- Magnetic cap requires less handling, reduces hand exposure
- Virtually unbreakable
- Includes multi-colored labels for easy identification

Specifications:

- Dimensions:
O.D.: 1.44" dia. x 2.99" h (3.7 x 7.59 cm)
O.D.: (at grip ring): 1.74" dia. x 2.99 (4.4 x 7.59 cm)
I.D.: 1.02" dia. x 2.25" h (2.6 x 5.7 cm)
- Attenuation: > 99% for Tc-99m
- Tungsten Shielding: 0.2" thick (.51 cm)
- Lead Equivalency: 0.286" thick lead for Tc-99m
- Accommodates Vial Size: 10 ml
- Weight: 1.75 lb (0.80 kg)

053-806	Vial Shield, 0.2" Tungsten, Magnetic Cap <i>Includes a sheet of colored labels</i>
----------------	---

Shielding & Storage



Tungsten Vial Shield

The Tungsten Vial Shield is designed to greatly reduce exposure to vials containing liquid radioisotopes. The shield is machined with 0.2" thick tungsten, equivalent to 0.286" lead at 140 keV.

The tungsten will retain its shape under the roughest handling conditions and is virtually unbreakable.

Features:

- Virtually unbreakable
- Safe handling of radioactive liquids

Specifications:

- Dimensions:
O.D.: 1.44" dia. X 2.8" h (3.7 x 7 cm)
I. D.: 1" dia. x 2.25" h (2.5 x 5.7 cm)
- Attenuation: > 99% for Tc-99m
- Tungsten Shielding: 0.2" thick (.51 cm)
- Lead Equivalency: 0.286" thick lead for Tc-99m
- Accommodates Vial Size: 10 ml
- Weight: 1.65 lb (0.75 kg)

053-807 Vial Shield, Tungsten



Lead Vial Shield

This Vial Shield is designed to aid in preparation of radiopharmaceuticals that require boiling.

Vents are located to minimize scatter leakage, boiling water can circulate freely around the vial, heating the solution rapidly and uniformly. The carrying handle makes it easy to lower and remove the vial from the boiling water bath.

The vial is constructed of lead .25" thick. A 5.6 density flush mounted lead glass window provides protection and visibility. The radiation level for 25 mCi of Tc-99m is reduced to background.

Specifications:

- Dimensions: 2" dia. x 3.875" h (5 x 9.8 cm)
- Lead Shielding: .25" thick (.64 cm)
- Accommodates Vial Sizes:
up to 1.5" dia. x 3.125" h (3.8 x 7.9 cm)
- Weight (including handle): 3 lb (1.4 kg)

001-236 Vial Shield, .25" lead



PET Vial Pig

Vials containing PET or other high-energy radionuclides can be safely transported in this Vial Pig. The pig offers a minimum of 1" of lead shielding to accommodate the concentrated energy.

The Vial Pig can be used independently or with the PET Shipping System, which meets DOT II Type A packaging requirements.

Specifications:

- Dimensions:
O.D: 6.63" h x 4.15" dia. (16.8 x 10.5 cm)
I.D: 2.76" h x 1.51" dia. (7 x 4.4 cm)
- Lead Shielding:
Sides and Bottom: 1" thick (2.5 cm)
Top: 1.75" (3.8 cm)
- Weight: 21.3 lb (9.7 kg)

001-706 Pig, Vial, PET, 1" lead
Transports 10*, 20* &
30 ml vials.
*Requires Vial/Pig
Adapter, sold separately.

Related:
001-771 Sheets, Absorbent,
100/pkg
001-707 Adapter, Vial Pig, 10 ml
Allows 001-706 Vial Pig to
accommodate 10 ml vials
001-711 Adapter, Vial Pig, 20 ml
Allows 001-706 Vial Pig to
accommodate 20 ml vials

Shielding & Storage



High Density Lead Glass Vial Shield

The High Density (5.6) Lead Glass Vial Shield reduces hand exposure and offers complete 360° visibility. The lead glass vial shield is suitable for low-energy radioisotopes.

The shield has a removable cap that makes cleaning and needle insertion as simple as possible while maintaining a sleek attractive appearance.

Automatic centering action positions vials within the shield and holds them securely for extra safety and convenience.

Features:

- Lead glass provides clear visibility
- Accommodates most vials
- Centering action holds vials securely

Specifications:

- Lead Equivalency: .12" (3 mm)
- HVL for 99m-Tc: 10
- Accommodates Vial Sizes: 5 through 30 ml
- Weight: 3 lb (1.4 kg)

001-075 Vial Shield, .12" lead equiv.

Related:

066-533 Forceps, Curved, locking, 9.5" l (24.1 cm)
066-535 Forceps, Straight, locking, 9.5" l (24.1 cm)
066-536 Forceps, Curved, non-locking, 12.5" l (31.7 cm)



Figleaf Gonad Shields

Effectively protect female reproductive organs during pelvic radiography, angiography and fluoroscopy

Proper shielding is vital to any woman of childbearing age and her offspring. The Figleaf Gonad Shields effectively protect female reproductive organs during pelvic radiography, angiography and fluoroscopy. Unlike most shielding devices for the ovaries, uterus and fallopian tubes, our Figleaf Gonad Shields DO NOT obscure diagnostically important surrounding bone structures.

Maximum Protection

Figleaf Shields provide the protective shielding of 1 mm lead equivalency and consistently blocks a minimum of 65% of all direct-beam radiation to gonadal tissues and significantly reduces scatter to vital organ areas.

How To Use The Figleaf Shield

Proper positioning of the Figleaf Shield places the shield's vertical line directly on the mid-sagittal line of the patient's abdomen – with the bottom edge of the shield aligned 1/2" (1.3 cm) to 3/4" (2.0 cm) above the pubic symphysis. When properly positioned, the Figleaf Shield is secured to close-fitting undergarments with microspore tape for best results.

Selection of the correct-size Figleaf Shield is based upon the patient's abdominal thicknesses. When the Figleaf Shield is positioned on the patient, the shield is separated by some distance from the ovaries and by an even greater distance from the X-ray film surface. This causes magnification of the shield shadow at the level of the ovaries and even more magnification at the film surface. By factoring magnification, a small Figleaf Shield can be used to give complete gonadal shielding without obscuring pelvic bone.

Specifications:

- Small: 3.2" w x 2.4" h (8 x 6 cm)
- Medium: 4" w x 2.75" h (10 x 7 cm)
- Large: 4.75" w x 3.2" h (12 x 8 cm)

117-808 Gonad Shields, Figleaf, 3/set

Note: Product contains lead.

Handle with gloves and avoid skin contact.

Shielding & Storage



For added protection, store loaded syringes in the Shielded Syringe Holder.

Shielded Syringe Holder

Accommodates shielded and unshielded syringes

This Shielded Syringe Holder will accommodate unshielded syringes and syringes in a syringe shield.

The Syringe Holder is constructed of lead shielding, encased in steel. The shielding tapers from .25" - .5" lead. The large diameter base ensures stability.

Specifications:

- Dimensions: 6.5" h (16.5 cm)
I.D.: .84" dia. x 5.6 h (2.1 x 14.3 cm)
- Lead Shielding: .25" - .5" thick (.64 cm - 1.3 cm)
- Accommodates Syringe Shields:
Pro-Tec II: 1 cc, 3 cc, 5 cc
Pro-Tec III: 1 cc, 3 cc, 5 cc
Pro-Tec IV: 1 cc
- Weight: 6 lb (2.7 kg)



Syringe Shield Holder

Protect your investment

Don't let your syringe shields roll around on the counter. The Syringe Shield Holder offers a means of protecting syringe shields from scratches or misplacement while freeing up extra work space. The Syringe Shield Holder will support up to eight shields and is counterbalanced to prevent tipping. Know exactly where syringe shields are when you need them.

Specifications:

- Dimensions: 7.5" w x 4" depth x 6" h (19 x 10.2 x 15.2 cm)
- Weight: 5 lb (2.3 kg)

009-205 Syringe Holder, Shielded

007-999 Syringe Shield Holder

Shielding & Storage



Shielded Syringe Carriers

Shielded Syringe Carriers reduce exposure while storing or transporting radioactive material. The overlapping lid design with snap-latch closure prevents streaming. There are two sizes, offered in .125" and .25" lead shielding for added protection. The ends of the carriers are double thick to reduce the exposure from the ends of syringes.

Specifications:

001-179 Shielded Syringe Carrier, Large

- Dimensions:
I.D.: 8.25" l x 3" w x 2.9" h
(21 x 7.6 x 7.4 cm)
O.D.: 9.5" l x 4.4" w x 3.5" h
(24 x 11.2 x 8.9 cm)
- Lead Shielding:
Sides, top and bottom:
.125" thick (.32 cm)
Ends: .25" thick (.64 cm)
- Weight: 11.3 lb (5.1 kg)

001-181 Shielded Syringe Carrier, Small

- Dimensions:
I.D.: 8" l x 1.9" w x 1.97" h
(20.3 x 4.8 x 5 cm)
O.D.: 9.25" l x 3.4" w x 2.6" h
(23.5 x 8.6 x 6.6 cm)
- Lead Shielding:
Sides, top and bottom:
.125" thick (.32 cm)
Ends: .25" thick (.64 cm)
- Weight: 7.5 lb (3.4 kg)

001-182 Shielded Syringe Carrier, Small

- Dimensions:
I.D.: 7.5" l x 1.7" w x 1.7" h
(19 x 4.3 x 4.3 cm)
O.D.: 9.25" l x 3.4" w x 2.6" h
(23.5 x 8.6 x 6.6 cm)
- Lead Shielding:
Sides, top and bottom:
.25" thick (.64 cm)
Ends: .5" thick (1.3 cm)
- Weight: 11 lb (4.9 kg)

001-180 Shielded Syringe Carrier, Large

- Dimensions:
I.D.: 7.7" l x 2.6" w x 2.7" h
(19.6 x 6.6 x 6.9 cm)
O.D.: 9.5" l x 4.4" w x 3.5" h
(24 x 11.2 x 8.9 cm)
- Lead Shielding:
Sides, top and bottom:
.25" thick (.64 cm)
Ends: .5" thick (1.3 cm)
- Weight: 17 lb (7.7 kg)

Shielded Syringe Carrier, .125" lead:

- 001-181** Syringe Carrier, Small
- 001-179** Syringe Carrier, Large

Shielded Syringe Carrier, .25" lead:

- 001-182** Syringe Carrier, Small
- 001-180** Syringe Carrier, Large



Eliminate clutter and reduce safety hazards with convenient Shielded Storage Containers.

Molded plastic liner with threaded lid fits Storage Container 050-250.

Shielded Storage Containers

For beta and gamma radiation

Shielded Storage Containers are useful for storing used syringes, alcohol wipes, etc., that may be contaminated with low-energy gamma or beta radiation residue prior to disposal.

All sizes are fashioned of lead-lined stainless steel, but the 050-205 is lined with both lead and aluminum. This shielding combination attenuates gamma radiation, beta radiation and errant bremsstrahlung.

Specifications:

050-200 Shielded Storage Container, Gamma, Small

- Dimensions: 6.5" h x 5" dia. (16.5 x 12.7 cm)
- Lead Shielding: .125" thick (.32 cm)
- Weight: 7 lb (3.2 kg)

050-250 Shielded Storage Container, Gamma, Large

- Dimensions: 7" h x 6" dia. (17.8 x 15.2 cm)
- Lead Shielding: .125" thick (.32 cm)
- Weight: 9 lb (4.1 kg)

050-205 Shielded Storage Container, Beta/Gamma, Small

- Dimensions: 6.5" h x 5" dia. (16.5 x 12.7 cm)
- Lead Shielding: .25" thick (.64 cm)
- Aluminum Shielding: .0625" thick (1.6 mm)
- Weight: 12 lb (5.4 kg)

- 050-200** Shielded Storage Container, Gamma, Small, Stainless Steel, Lead Lined
- 050-250** Shielded Storage Container, Gamma, Large, Stainless Steel, Lead Lined
- 050-205** Shielded Storage Container, Beta/Gamma, Small, Stainless Steel, Lead/Al Lined

Related:

- 007-007** Liner, Molded Plastic, 12/pkg
Fits 050-250
- 040-315** Liner, Poly Bag, 100/pkg
Measures 6" x 3" x 15"
Fits 050-200, 050-250 and 050-205

Shielding & Storage



Monoject Sharps Container
0660-1811.

Vertical Drop CII Sharps Shield

A convenient way to store spent syringes in a safe manner

These Sharps leaded container cabinets offer a convenient way to store spent syringes in a safe manner. Two sizes are shown: One is designed for containment of one medium-size Chimney-Top Monoject Sharps container and the other holds two small or one large Monoject Sharps Container.

The Vertical Drop CII Sharps Shield comes with a Key-Lock safety feature not found elsewhere. The hinged top is easily opened to remove the Sharps container for replacement, requiring no removal of a heavy lid. Shielded with 1/8" lead, this unit can be specified with 1/4" shielding. The Vertical Drop CII Sharps is designed to use a Chimney-Top Sharps Container which protects the user's fingers in use. Convenient needle notches facilitate safe and rapid removal of needles from tube holders.

Features:

- All units have Key-Lock tops to meet OSHA requirements
- Table Top or Flush Mount in work counter
- Single or double stacked models
- Lead thickness 1/8" or 1/4"
- Hinged top for easy opening and removal of sharps

Specifications:

- Standard Model
Shielding: .125" lead with 4 pi shielding
Dimensions: 11" h x 7.25" w x 11" l (28 x 18.4 x 28.2 cm)
Weight: 54 lb (24.5 kg)
- Tall Model
Shielding: .125" lead with 4 pi shielding
Dimensions: 18" h x 7.25" w x 11" l (45.7 x 18.4 x 28 cm)
Weight: 76 lb (34.5 kg)

- 0660-0018** Vertical Drop CII Sharps Shield (Standard)
- 0660-0019** Vertical Drop CII Sharps Shield (Tall)
- 0660-1811** Monoject Sharps Medium (For Standard) 20/box
- 0660-1813** Monoject Sharps Small (For Tall) 40/box



Horizontal Drop CII Sharps Shield

Comes with hinged top and easy opening

These Sharps leaded containers are available for Nuclear Medicine needs. Designed for containment of one medium size Horizontal-Entry Monoject Sharps Container or one medium Gator Sharps container.

The Horizontal Drop CII Sharps Shield comes with a Key-Lock safety feature, and hinged top with easy opening for replacement. Shielded with 1/8" lead, this unit can be specified with 1/4" shielding. The Horizontal Drop CII Sharps is designed to use a Horizontal-Entry Sharps Container with greater filling capacity since the syringes lie flat.

Features:

- All units have Key-Lock tops to meet OSHA requirements
- Lead thickness 1/8" or 1/4"
- Hinged top for easy opening and removal of sharps

Specifications:

- Shielding: .125" lead with 4 pi shielding
- Interior Dimensions: 11" h x 7.25" w x 11" l (28 x 18.4 x 28.2 cm)
- Exterior Dimensions: 12.625" h x 9.19" w x 13.75" l (32 x 23.34 x 35 cm)
- Weight: 52 lb (23.6 cm)

- 0660-0038** Horizontal Drop CII Sharps Shield (Standard)

Shielding & Storage



High-Energy Sharps Container Shield

This Sharps Container Shield is a simple, safe and convenient solution for disposal of used syringes that may be contaminated with high-energy isotopes such as I-131. The shield is constructed of steel lined with .5" of lead (1.3 cm).

The shield features a hinged top with a sliding port and side handles which allow for easy transport. It will accommodate both small and medium Monoject Sharps containers.

Specifications:

- Dimensions:
I.D.: 7" l x 11.38" w x 11.25" h
O.D.: 9.19" l x 15.25" w x 13.31" h
- Lead Shielding: .5" thick (1.3 cm)
- Security: Key-locked
- Finish: Powder coat
- Weight: 160 lb (72.3 kg)

039-326 Sharps Container Shield, .5" lead



0660-0042 PET
Sharps Insert.

PET Sharps Container Shield

Hinged cover for syringe disposal

The Capintec PET Sharps Container Shield is constructed to stand alone or to be recessed within a countertop. The shield is constructed of steel with 1" lead lining and allows for simple and convenient disposal of 511 keV radionuclides.

Features:

- Hinged cover for syringe disposal
- Sliding top with lock for container removal

Specifications:

- Dimensions: 13.5625" h x 10.625" od x 6.125 id
(34.4 x 27 x 15.6 cm)
- Weight: 160 lb (72.6 kg)
- Lead Lining: 1" (2.5 cm)

5730-2271 PET Sharps Container Shield

Related:
0660-0042 PET Sharps Inserts

Shielding & Storage



Syringe Recapper

Syringe recapping device

Don't put yourself at risk with an accidental needle stick! The Syringe Recapper is a safe and inexpensive way to protect yourself when recapping a used syringe. Used either hand-held or placed on a flat surface, such as a procedure tray, the Recapper is made of a lightweight plastic that is easily carried anywhere.

Specifications:

- Dimensions: 3.25" l x 2.75" w (8.3 x 7 cm)



Shielded Waste Container

For low-energy beta and gamma waste

This Shielded Waste Container is used in facilities that generate low-energy beta and gamma radiation waste.

The interior of the container is constructed of .063" aluminum and .25" lead. The shielding combination attenuates gamma radiation, beta radiation and errant bremsstrahlung.

Extra protection is provided with a specially designed hatch door that protects the user from container contents even while open. Convenient side handles let you easily lift the container top to empty decayed contents. Sleek and sturdy, the exterior is constructed of steel, with a powder-coat finish.

Specifications:

- Dimensions: 12" w x 22" h x 9" d (30 x 56 x 23 cm)
I.D.: 10.5" w x 14.5" h x 8.5" d (27 x 37 x 22 cm)
- Lead Shielding: .25" thick (6 mm)
- Aluminum Shielding: .063" thick (1.6 mm)
- Finish: Powder coat
- Shipping Weight: 120 lb (54 kg)

008-300 Syringe Recapper

039-110 Waste Container, Shielded, .25" lead
Includes 20 Poly Liners

Replacement:
040-108 Liner, Poly, 20/pkg

Shielding & Storage



Shielded Waste Container

For low-energy gamma waste

The Shielded Waste Container is a must-have item for any facility that generates low-energy gamma radiation waste. Constructed entirely of 18-gauge stainless steel and lined with .125" lead, this 20-quart container can be placed on the floor or counter. Simply lift off the shielded cover for quick disposal of waste. Plastic liners make it easy to transfer waste to a decay or disposal site once the container is filled.

Specifications:

- Dimensions: 11.9" w x 9.9" depth x 15.25" h (30.2 x 25.1 x 38.7)
- Lead Shielding: .125" thick (3 mm)
- Capacity: 20 qt (18.9 L)
- Weight: 51 lb (22.6 kg)

039-106 Waste Container, Shielded, .125" lead
Includes 20 Poly Liners

Replacement:
040-108 Liner, Poly, 20/pkg



12 Gallon Step Waste Can

Reduces hand exposure

Features:

- Rugged Steel Construction
- Positive leverage foot pedal with hinged lid for hands-free operation
- Shielded with 1/8" of lead - ideal for low energy radioactive waste
- Includes rigid spill proof liner
- Available in durable white glossy finish or stainless steel exterior

Specifications:

- Dimensions: 23" h x 12" d x 12" w (58.4 x 30.5 x 30.5 cm)
- Weight: 80 lb (36.3 kg)
- Circumference: 48" (121.92 cm)
- Capacity: 12 gal (45.4 kg)

5530-20178 12 Gallon Step Waste Can, White
5530-20179 12 Gallon Step Waste Can, Stainless Steel

Shielding & Storage

Compact PET Shipping Systems for One, Two or Three Unit Dose Pigs

The Compact PET Shipping Systems transport one, two or three 3 cc or 5 cc doses containing high-energy radionuclides such as FDG F-18. Dose syringes fit into the pig with or without an attached needle. The shipping container is designed to conserve space and minimize weight. An important feature is that the shipping container can be left at a convenient height while the pig (9 lb) can be easily removed from the container. The pig is then placed behind an L-Block Shield for dose loading and unloading.

Compact PET Shipping Systems for one, two or three unit dose pig(s) consist of:

- PET Unit Dose Pig(s)
- Absorbent sheets
- Shipping container with lead shielding

Specifications:

001-786 PET Shipping System, Single Dose

- Dimensions:
Container: 11.75" l x 11.75" w x 12.5" h (29.8 x 29.8 x 31.8 cm)
Cubic Feet: ~1 cu ft (.03 cu meters)
- Weight (Combined): 38.3 lb (17.5 kg)
- Regulations:
Meets DOT Yellow II Type A packaging requirements when shipping up to 500 mCi (18.5 GBq) of FDG F-18



001-787 PET Shipping System, Double Dose

- Dimensions:
Container: 11.75" l x 11.75" w x 12.5" h (29.8 x 29.8 x 31.8 cm)
Cubic Feet: ~1 cu ft (.03 cu meters)
- Weight (Combined): 55.2 lb (25.2 kg)
- Regulations:
Meets DOT Yellow II Type A packaging requirements when shipping up to 160 (5.92 GBq) and 235 mCi (8.70 GBq) of FDG F-18



001-739 PET Shipping System, Triple Dose

- Dimensions:
Container: 11.75" l x 11.75" w x 12.5" h (29.8 x 29.8 x 31.8 cm)
Cubic Feet: ~1 cu ft (.03 cu meters)
- Weight (Combined): 95 lb (43.1 kg)
- Regulations:
Meets DOT Yellow II Type A packaging requirements when shipping up to 235 (8.70 GBq), 160 (5.92 GBq) and 140 mCi (5.18 GBq) of FDG F-18
Meets IATA Dangerous Goods Regulations, 60th Edition Sections 5.0.4.3, 10.5, and 10.6.1 through 10.6.3.5
- Compliance reports for radioactive materials packaging are available by request.



001-786 PET Single Dose Shipping System.



001-787 PET Double Dose Shipping System.

Shielding & Storage



001-739 PET Triple Dose Shipping System.



PET Unit Dose Pig

The 001-785 Unit Dose Pig is encapsulated in durable, high-impact Lexan and polypropylene, making the pig durable, easy to clean and compatible with automatic washing systems. All PET L-Block Shields incorporate a hex-shaped plate that corresponds with the hex shape at the base of the pig. This design element allows one-handed loading and unloading of syringes. A single twist opens or closes the pig, reducing handling time.

Features:

- Single twist thread to open and close
- No exposed lead
- Compatible with automatic washing equipment

Specifications:

- Dimensions: 10.2" h x 2.4" dia. (26 x 6 cm)
- Lead Shielding:
 - Body: .5" thick (1.3 cm)
 - Ends: Top: 1.44" thick (3.6 cm)
 - Bottom: 1.2" thick (3 cm)
- Weight: 8.7 lb (4 kg)

- 001-786** Shipping System, PET, Single Dose
For single Unit Dose Pig
Includes: 001-785 Unit Dose Pig, absorbent sheets and shipping container with lead shielding
- 001-787** Shipping System, PET, Double Dose
For two single Unit Dose Pigs
Includes: Two 001-785 Unit Dose Pigs, absorbent sheets and shipping container with lead shielding
- 001-739** Shipping System, PET, Triple Dose
For three single Unit Dose Pigs
Includes: Three 001-785 Unit Dose Pigs, absorbent sheets and shipping container with lead shielding

Related:

- 001-284** Pig Rack, PET
- 001-730** Cart, Transport, PET Shipping System
- 001-771** Sheets, Absorbent, 100/pkg
- 001-726** Tags, Wire Security, 25/pkg
Used to identify unauthorized access
- 001-721** Document Protector, 100/pkg

U.S. Patent No. 6,586,758
U.S. Patent No. 6,822,253
U.S. Patent No. 6,963,073
U.S. Patent No. 7,019,317

- 001-785** Pig, Unit Dose, PET, 3/5 cc, .5" lead
Accommodates syringes with or without needle
- 001-798** Pig, Unit Dose, PET, 10 cc, .5" lead
Accommodates a 10 cc syringe with or without needle, filled to 6cc
- Note: Each Pig is sold in multiples of three.

Related:

- 001-284** Pig Rack, PET
- 001-771** Sheets, Absorbent, 100/pkg

Shielding & Storage

Intego™ Vial Shipping System

The Vial Shipping System employs a unique Tungsten Vial Shield for use with the Medrad Intego PET Infusion System. Manufactured to Medrad specifications, the Vial Shield transports a 30 ml Hospira vial.

To lift or lower the vial within the container or the Intego Infusion System, a detachable handle is provided. Accommodation is made for the handle to travel with the shipping container.

The system meets DOT Yellow II Type A packaging requirements when shipping up to 2.5 Ci (92.5 GBq) of FDG F-18.

Specifications:

001-708 Vial Shield with Lifting Handle

- Weight: 15.2 lb (6.89 kg)

001-723 Intego Shipping Container

- Dimensions:
Container: 11.75" l x 11.75" w x 12.5" h (29.8 x 29.8 x 31.8 cm)
Cubic Feet: ~1 cu ft (.03 cu meters)
- Weight: 48.8 lb (22.1 kg)
- Weight (Combined): 64 lb (29 kg)
- Regulations:
Meets DOT Yellow II Type A packaging requirements when shipping up to 2.5 Ci (92.5 GBq) of FDG F-18
Meets IATA Dangerous Goods Regulations, 60th Edition Sections 5.0.4.3, 10.5, and 10.6.1 through 10.6.3.5
- Compliance reports for radioactive materials packaging are available by request.



- 001-708** Vial Shield, Tungsten, Intego
For 30 ml Hospira vials.
Includes lifting handle.
- 001-723** Shipping Container, Intego

- Related:**
- 001-730** Cart, Transport, PET Shipping System
 - 001-726** Tags, Wire Security, 25/pkg
Used to identify unauthorized access
 - 001-721** Document Protector, 100/pkg

U.S. Patent No. 6,586,758

Shielding & Storage

Compact PET Shipping System for Vial Pig

The PET Shipping System for Vial Pigs is designed to transport a 10, 20 or 30 ml vial containing high-energy radionuclides. Designed to conserve space and minimize weight, the entire system weighs only 50 lb. An important feature is that the shipping container can be placed at a convenient height while the pig is easily removed from the shipping case. For added safety and convenience, the vial pig can then be placed in the 042-466 Dose Drawing System for drawing doses from the vial.

The system meets DOT Yellow II Type A packaging requirements when shipping up to 1.5 Ci (55.5 GBq) of FDG F-18.

PET Shipping System for Vial Pigs consists of:

- PET Vial Pig
- Absorbent Sheets
- Shipping Container with lead shielding

Specifications:

001-706 Vial Pig

- Dimensions:
 - Exterior: 6.63" h x 4.15" dia. (16.8 x 10.5 cm)
 - Interior: 2.76" h x 1.51" dia. (7 x 3.8 cm)
- Lead Shielding:
 - Sides and Bottom: 1" thick (2.5 cm)
 - Top: 1.75" (4.4 cm)
- Weight: 21.3 lb (9.7 kg)

001-724 PET Shipping System, Vial

- Dimensions:
 - Container: 11.75" l x 11.75" w x 12.5" h (29.8 x 29.8 x 31.8 cm)
 - Cubic Feet: ~1 cu ft (.03 cu meters)
- Weight (Combined): 49.7 lb (22.5 kg)
- Regulations:
 - Meets DOT Yellow II Type A packaging requirements when shipping up to 1.5 Ci (55.5 GBq) of FDG F-18
 - Meets IATA Dangerous Goods Regulations, 60th Edition Sections 5.0.4.3, 10.5, and 10.6.1 through 10.6.3.5
- Compliance reports for radioactive materials packaging are available by request.



001-724 System, PET, Vial*
Includes: 001-706 Vial Pig and shipping container with lead shielding

Components:

001-706 Pig, Vial, PET, 1" lead
Transports 10*, 20* & 30 ml vials.
*Requires Vial/Pig Adapter, sold separately.

Related:

001-707 Adapter, Vial Pig, 10 ml
Allows 001-706 Vial Pig to accommodate 10 ml vials

001-711 Adapter, Vial Pig, 20 ml
Allows 001-706 Vial Pig to accommodate 20 ml vials

001-730 Cart, Transport, PET Shipping System

001-771 Sheets, Absorbent, 100/pkg

001-726 Tags, Wire Security, 25/pkg
Used to identify unauthorized access

001-721 Document Protector, 100/pkg

U.S. Patent No. 6,586,758

Shielding & Storage

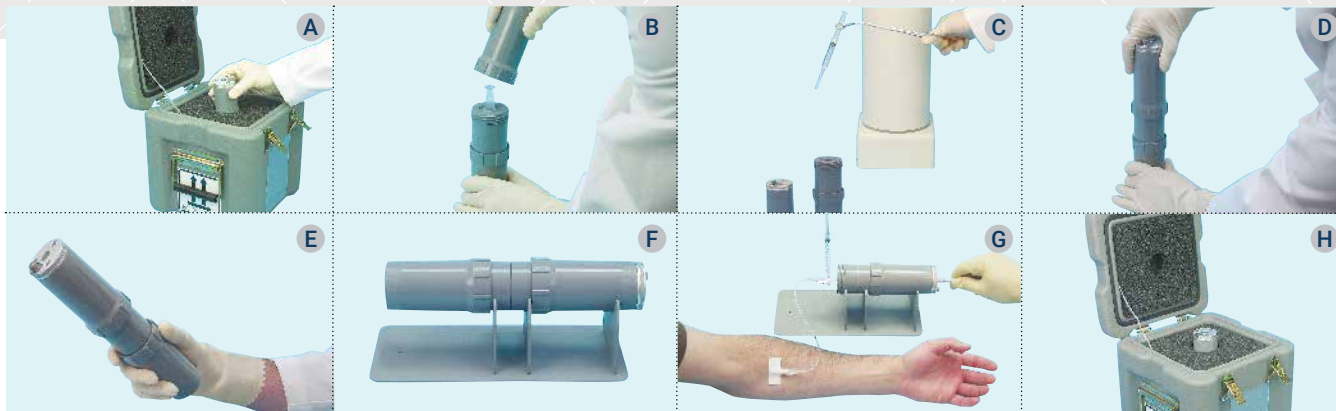

Compact PET Shipping System for Double-Ended PET Pig

One system for shipping and injecting FDG F-18

The Double-Ended PET Pig is an all-in-one solution for the safe transport and administration of 511 keV radionuclides, such as FDG F-18. The pig is constructed in three sections of .6" (1.5 cm) lead enclosed in durable Lexan. Depending on the stage of the injection process, only one section of the pig is removed. The injection itself is accomplished without removing the syringe from the pig. Simply open the administration port and push the tungsten plunger against the syringe plunger. During injection the pig is positioned on a stand. The Double-Ended Pig accommodates a 5 cc syringe and fits into its own compact shipping container. The system employs a unique design that decreases the weight and size of the container.

Here's how it works:

1. Remove the Double-Ended Pig from the compact shipping container. (See dia. A.)
2. Place behind an L-Block Shield.
3. Unscrew the top. (See dia. B.)
4. Remove the syringe and place into a dose calibrator. (See dia. C.)
5. Return the syringe to the pig and put the top back on. (See dia. D.)
6. Transport the pig to the patient injection area. (See dia. E.)
7. Place the pig into the Pig Cradle so the top section of the pig is over the long section of the cradle. (See dia. F.)
8. Remove the bottom of the pig and connect to your preferred injection device, butterfly, etc. (See dia. G.)
9. Open the plunger lock located on the top section by pulling the slide toward the edge of the pig. With a pen-like device, push the tungsten plunger to administer the dose. (See dia. G.)
10. Recap the syringe.
11. Put the bottom back on the pig.
12. Return the pig to the compact shipping container. (See dia. H.)

Specifications:

001-793 Double-Ended PET Pig

- Dimensions: 9.5" h x 2.3" dia. at maximum point (24 x 5.8 cm)
- Shielding:
 - Sides: .6" thick (1.5 cm) lead
 - Bottom: 1.44" thick (3.7 cm) lead
 - Top: .875" thick (2.2 cm) tungsten
- Weight: 9 lb (4 kg)

001-794 PET Shipping System, Double-Ended Pig

- Dimensions:
 - Container: 11.75" l x 11.75" w x 12.5" h (29.8 x 29.8 x 31.8 cm)
 - Cubic Feet: ~1 cu ft (0.3 cu meters)
- Weight: 36 lb (16.3 kg)
- Regulations:
 - Meets DOT Yellow II Type A packaging requirements when shipping up to 475 mCi (17.58 GBq) of FDG F-18.
 - Meets IATA Dangerous Goods Regulations, 60th Edition Sections 5.0.4.3, 10.5, and 10.6.1 through 10.6.3.5.
- Compliance reports for radioactive materials packaging are available by request.



001-794 Shipping System, PET, Double-Ended Pig, Single
Includes one 001-793 Double-Ended PET Pig and Shipping Container with lead.

Component:

001-793 Pig, Double-Ended, PET, .6" lead
Accommodates 5 cc syringes with or without needle.

Related:

001-771 Sheets, Absorbent, 100/pkg
001-721 Document Protector, 100/pkg

U.S. Patent No. 6,586,758 B2
Other patents pending

Shielding & Storage

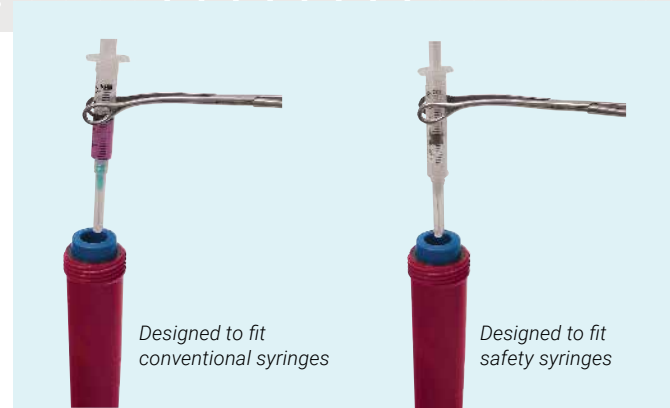
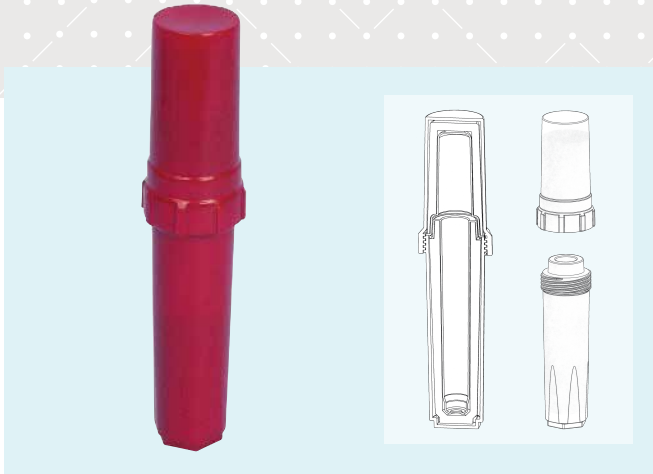

Pro-Tec™ Unit Dose Pig

The Pro-Tec Unit Dose Pig accommodates the most commonly used conventional and safety-engineered syringes. The lead components are fully encapsulated in durable Lexan, making this unit rugged and easy to clean. A single twist to open or close reduces loading/unloading time. The overlap design eliminates streaming regardless of the dose's position inside the pig.

A replaceable O-ring protects against leakage. Complete encapsulation of lead components in high-impact Lexan protects the lead shielding from physical damage during handling. The durable Lexan will not be damaged by automatic washing systems. Smooth plastic surfaces make the application and removal of adhesive labels easy. This product is designed to comply with IATA and DOT II requirements when transported in an appropriate shipping container.

Innovative and cost effective, the Pro-Tec Unit Dose Pig will help improve the safety and efficiency of radiopharmaceutical handling procedures. Pro-Tec shielding for safety syringes will help pharmacies and clinics adhere to ALARA principles and improve compliance with OSHA directives – without compromising efficiency.

Features:

- Attractive design
- Overlapped lead eliminates streaming
- Durable, high-impact Lexan encapsulates lead components
- Opens and closes with a single twist
- 0.25" thick lead shielding
- O-ring seal
- Fits into ammo cans (vertically and horizontally)
- Compatible with automatic washing equipment
- Accommodates the following syringes:
 - 3 cc BD
 - 3 cc BD Safety-Lok
 - 3 cc Monoject
 - 3 cc Monoject Safety
 - 5 cc BD
 - 6 cc Monoject
 - 10 cc BD

Specifications:

- Dimensions: 8.5" h x 1.94" dia. (22 x 4.9 cm)
- Lead Shielding: 0.25" nominal thickness (0.64 cm)
- Construction: Lead, fully encapsulated with polycarbonate on the outside and polypropylene on the inside
- Color: Red, White, Blue
- Weight: 3 lb (1.4 kg)

- 001-280** Unit Dose Pig, Pro-Tec, Red
001-281 Unit Dose Pig, Pro-Tec, White
001-282 Unit Dose Pig, Pro-Tec, Blue
Note: Each Pig is sold in multiples of six.

U.S. Patent No. 6,822,253
 U.S. Patent No. 6,963,073
 U.S. Patent No. 7,019,317

Related:

- 008-400** Wall Rack, Unit Dose Pig
001-283 Pig Rack, Pro-Tec
001-754 Shipping Bag, Pro-Tec Pig
066-533 Forceps, Curved, Locking, 9.5" l (24.1 cm)

Shielding & Storage



Accommodates up to 11 Pro-Tec Pigs

Pro-Tec™ Pig Shipping Bag

The durable, nylon, waterproof shipping bag is designed to accommodate up to 11 Pro-Tec Pigs containing syringes, ensuring safe, convenient handling of syringes from the pharmacy and back again. The system meets DOT 7A Type A packaging requirements.

Specifications:

- Dimensions: 10.5" h x 5.75" w x 11.5 depth (26.7 x 14.6 x 29.2 cm)
- Material:
 - Exterior: Nylon
 - Interior: Polyester
- Regulations:
 - Meets DOT 7A Type A packaging requirements.
 - Meets IATA Dangerous Goods Regulations, 60th Edition Sections 5.0.4.3, 10.5, and 10.6.1 through 10.6.3.5.
- Compliance reports for radioactive materials packaging are available by request.



001-754 Shipping Bag, Pro-Tec Pig

Related:

001-280 Unit Dose Pig, Pro-Tec, Red
001-281 Unit Dose Pig, Pro-Tec, White
001-282 Unit Dose Pig, Pro-Tec, Blue

Replacement:

001-756 Placard, Type I, 100/pkg
001-757 Placard, Type II, 100/pkg
001-779 Covers, hook & loop fasteners, plastic, Lg, 160 x 180 mm, 50/pkg

U.S. Patent No. 6,822,253
 U.S. Patent No. 6,963,073
 U.S. Patent No. 7,019,317



Zevalin™ Unit Dose Pigs In-111 or Y-90

Designed to reduce exposure from gamma emitting radiopharmaceuticals, the Zevalin In-111 Unit Dose Pig is constructed of lead, encased in a durable Lexan. The pig accommodates a 10 cc B-D syringe filled to capacity. The Zevalin Y-90 Unit Dose Pig is constructed of lead and acrylic, encased in a durable Lexan. Reducing exposure from beta emitting radiopharmaceuticals, the pig accommodates a 10 cc B-D syringe filled to 9 cc.

Specifications:

- 001-789 Zevalin In-111 Unit Dose Pig
- Dimensions: 10.3" l x 2.3" dia. (26 x 5.8 cm)
 - Lead Shielding: .5" thick (1.3 cm)
 - Weight: 8.2 lb (3.7 kg)
- 001-788 Zevalin Y-90 Unit Dose Pig
- Dimensions: 10.3" l x 2.3" dia. (26 x 5.8 cm)
 - Lead Shielding: .09" thick (2.3 mm)
 - Acrylic Shielding: .36" thick (9.1 mm)
 - Weight: 3 lb (1.4 kg)

001-789 Pig, Unit Dose, Zevalin In-111
Accommodates 10 cc syringe with or without needle, filled to 10 cc

001-788 Pig, Unit Dose, Zevalin Y-90
Accommodates 10 cc syringe with or without needle, filled to 9 cc

Related:

001-284 Pig Rack, PET
001-771 Sheets, Absorbent, 100/pkg

U.S. Patent No. 6,822,253
 U.S. Patent No. 6,963,073
 U.S. Patent No. 7,019,317

Shielding & Storage



Unit Dose Pig Wall Rack

Improve lab safety, efficiency and organization with the Unit Dose Pig Wall Rack.

The wall rack improves work space with its pigeonhole design and reduces unnecessary handling. Unit doses can be identified at a glance. The rack's sturdy construction will hold up to 25 unit dose pigs.

Specifications:

- Dimensions: 17" w x 18" h (43.2 x 45.7 cm)



PET Pig Rack

Designed for countertop use, the PET Pig Rack holds up to eight PET pigs safely and conveniently.

The bottom of the rack has hexagonal cutouts that match the bottom of a pig to ensure each pig is held securely. When inserted into the rack, the pig can be easily opened or closed with a single twist.

Specifications:

- Dimensions: Overall: 12" w x 1.75" h x 6" depth (30.5 x 4.4 x 15.2 cm)
Upper holes: 2" dia. (5 cm)
Lower holes: 1.625" hex (4.1 cm)
- Weight: 2.8 lb (1.3 kg)

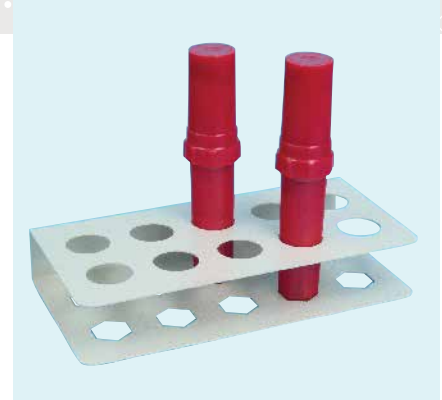

Pro-Tec™ Pig Rack

Designed for countertop use, the Pro-Tec Pig rack holds up to ten Pro-Tec Pigs safely and conveniently. The bottom of the rack has hexagonal cutouts that match the bottom of a Pro-Tec Pig to ensure each pig is held securely. When inserted into the rack, the pig can be easily opened or closed with a single twist.

Specifications:

- Dimensions: Overall: 12" w x 1.75" h x 6" depth (30.5 x 4.4 x 15.2 cm)
Upper holes: 1.5" dia. (3.8 cm)
Lower holes: 1.2" hex (3.1 cm)
- Weight: 2.8 lb (1.3 kg)

001-284 Pig Rack, PET

Related:

- 001-785** Pig, Unit Dose, PET, 3/5 cc, .5" lead
- 001-788** Pig, Unit Dose, Zevalin Y-90
- 001-789** Pig, Unit Dose, Zevalin In-111

U.S. Patent No. 6,822,253
U.S. Patent No. 6,963,073
U.S. Patent No. 7,019,317

001-283 Pig Rack, Pro-Tec

Related:

- 001-280** Unit Dose Pig, Pro-Tec, Red
- 001-281** Unit Dose Pig, Pro-Tec, White
- 001-282** Unit Dose Pig, Pro-Tec, Blue

U.S. Patent No. 6,822,253
U.S. Patent No. 6,963,073
U.S. Patent No. 7,019,317

008-400 Wall Rack, Unit Dose Pig

Shielding & Storage

Compact L-Block with Dose Calibrator Shield

Space-saving design – Ideal for mobile units

The unique Compact L-Block with Dose Calibrator Shield is designed to maximize space in facilities receiving and preparing doses of high-energy nuclides such as FDG F-18. This unit provides convenient access and viewing of the work area and incorporates a built-in calibration chamber shield. The special shield is designed to accommodate a chamber that is through-mounted in a countertop (customer responsible for installation). The chamber shield accommodates all Atomlab chambers and many others (check chamber shield specifications to determine fit). This combination of L-Block and dose calibrator shield eliminates the need to purchase interlocking shielding rings. This unit is constructed of lead encased in steel. It features a large 8" x 8" x 4" lead glass window with adjustable window angle, 1.5" thickness lead shielding in front, and 1" thick lead in the base and in the chamber shield. A special plate with a hex-shaped recess is mounted on the L-Block base to facilitate one-handed loading and unloading of dose pigs incorporating hex-shaped bottoms. The optional 042-434 Lead Brick Cave fits neatly into the sides of the vertical section to provide lateral shielding around the full perimeter of the L-Block's base. For hot labs in mobile vans, the optional Brick Cave Cover will prevent the cave from shifting when the vehicle is in motion.

Features:

- 1.5" thick lead shielding in front, 1" in base
- 8" x 8" x 4" adjustable lead glass window
- 1" thick lead shield surrounds calibration chamber
- Optional Lead Brick Cave for complete lateral shielding

Specifications:

042-433 Compact L-Block with Dose Calibrator Shield

- Dimensions: 18" w x 21.5" depth x 26" h (45.7 x 54.6 x 66 cm)
- Lead Shielding:
 - Front: 1.5" thick (3.8 cm)
 - Base: 1" thick (2.5 cm)
 - Calibrator Shield: 1" thick (2.5 cm)
- Calibrator Shield Inside Dimensions: 6.85" id x 10.25" h (17.4 x 26 cm)
- Lead Glass Window:
 - Dimensions: 8" w x 8" h x 4" thick (20.3 x 20.3 x 10.2 cm)
 - Density: 5.2 g/cm³
- Finish: Powder coat
- Weight: 570 lb (259 kg)
- Shipping Weight: 590 lb (267.6 kg)

042-434 Interlocking Lead Brick Cave

- Dimensions:
 - I.D.: 14" w x 20.5" depth x 16" h (35 x 52.1 x 40.6 cm)
- Lead Shielding: 2" thick (5 cm)
- Finish: Paint
- Weight: 597 lb (271 kg)

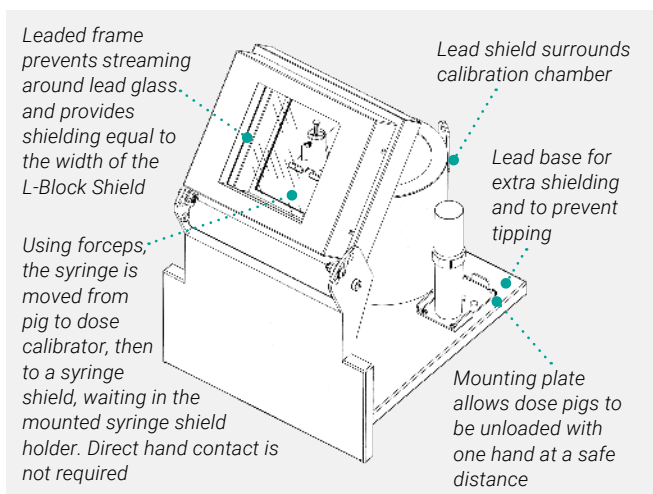

042-433 Compact L-Block with Dose Calibrator Shield, 1.5" lead
With built-in Dose Calibrator Shield

Related:
042-434 Lead Brick Cave, 3-wall, 2" lead
Fits 042-433 L-Block Shield

042-435 Lead Brick Cave Cover
Fits 042-434 Lead Brick Cave

Note: For use in countertops without a backsplash. Designed for mobile environments.

This L-Block Shields incorporate a hex-shaped plate to facilitate one-handed loading and unloading of PET Pigs.

Shielding & Storage

511 Spring Armed Dose Drawing Station

Proprietary spring arm design

The Capintec Dose Drawing Station was designed to help you meet the ALARA requirements of your department. With its proprietary spring arm design and exceptional shielding, the Dose Drawing Station is a fast and safety conscious way of handling your PET nuclides.

The Four Key Features

The Spring Arm

The Dose Drawing Station's proprietary spring arm design allows for quick and near effortless positioning of the 35 lb (16 kg) vial shield. With minimal exertion and minimal time the vial shield can be raised, lowered and/or inverted.

The 511 Vial Shield

There are two components to the vial shield. First is the inner T-vial shield, which is made of tungsten and provides a 1" (25.4 mm) lead equivalence. Second is the outer shield, which has 1" (25.4 mm) thick walls of epoxy-coated lead.

The Dose Drawing Syringe Shield

Included with the Dose Drawing Station is a Dose Drawing Syringe Shield in 5, 10 or 20 cc sizes. The syringe shield has a tungsten flange that provides maximum protection and locks onto the 511 vial shield with a twist of the wrist.

The 511 "L" Block Body Shield

Inside of the steel covering of the body shield lie interlocking 2 3/8" (6 cm) lead bricks. Mounted at a 20° angle on top of the steel cover is an 8" x 8" x 4" (51 x 51 x 25 cm) High Density lead glass view port.

Features:

- Designed for maximum radiation protection and greater flexibility when drawing doses
- Spring arm is constructed to provide ease of positioning and effortless lifting of the 35 lb tungsten vial
- Easily removable inner tungsten vial shield with 1" lead equivalence shielding
- Outer shield is 1" thick epoxy coated lead. In conjunction with the inner tungsten shield the user gets a combined 2" of lead shielding
- Flanged tungsten shield is manufactured to twist and lock into the tungsten vial shield. One flanged tungsten shield is included in the purchase of the dose drawing station. (When purchasing specify which shield size you would require, 5 cc, 10 cc or 20 cc)
- Lead glass is protected by 1/4" plate glass laminated to the front and back viewing surface to protect lead glass from scratching and chipping



Specifications:

- Dimensions: 22 1/2" w x 23 7/8" h x 22" d
- Lead Glass Window:
8" w x 8" h x 4" thick
Density: 5.2 g/cc density
- Lead Shielding: 2 3/8" Gapless lead shielding
- Weight: 250 lb

5510-3003 Drawing Station with body shield

Related:

0665-2017 5 cc Dose Drawing Syringe Shield
5530-1031 Painted Dose Drawing Station Brick Kit
 12" h x 32" w x 24" d x 2" Thick
 (31 x 82 x 61 x 5 cm)

Shielding & Storage

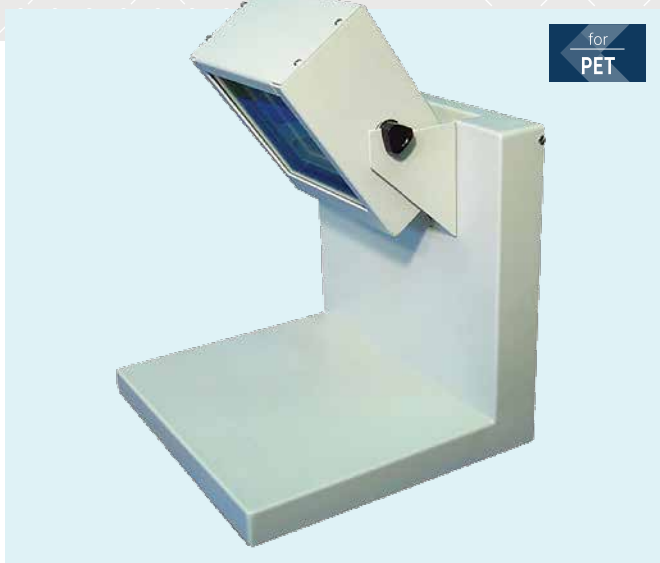

511 Adjustable L Block Table Top Shield

Adjustable lead glass window from 30-55 degrees

Designed to exceed the basic requirement of outstanding radiation protection, it now also boasts the luxury of an adjustable lead glass window for greater work area flexibility. The front wall shields with 2 3/8" thick lead and the window is 4" thick lead glass, with a clear glass cover to protect it from scratching. The front, base and glass frame are each constructed of high gauge steel for superior strength and stability.

Use the Adjustable L Block as a stand-alone unit. The optional Brick Kits (for side and back wall protection) will provide the perfect finishing touch for your 511 Adjustable L Block. The 511 "L" Block Shield is shipped in three pieces and easily assembled on site. Side walls are available as an option.

Features:

- Adjustable lead glass window from 30-55 degrees
- Clear glass covering to protect lead glass from chipping and scratching
- Steel construction for strength and stability
- Adjustable window angle of 30-55 degrees with respect to vertical

Specifications:

- Lead Shielding: 2 3/8" (6 cm)
- Lead Glass: 8" x 8" x 4" (20.32 x 20.32 x 10.16 cm) (5.2 density, 1.6" lead equivalence)
- Dimensions: 21" h x 15.75" w x 15.5" d (53.3 x 39 x 39.3 cm)
- Weight: 500 lb (227 kg)

5530-2077 511 Adjustable "L" Block Shield



511 L Block Table Top Shield

8" w x 8" h x 4" thick 5.2 g/cc Lead Glass

The 511 "L" Block Shield is placed in front of the Drawing Station and used to provide a protected work area for safe handling of 511 keV nuclides. The front wall and the base of the unit are constructed of steel with built-in lead shielding. A 4" thick lead glass window offers maximum protection and an unrestricted viewing area. In addition, the lead glass is protected from scratches and chips by a sheet of window.

Features:

- The fixed angle design of the lead glass allows easier viewing
- Contains two sheets of 1/4" window glass to protect lead glass from scratching and chips (Industry exclusive)
- Lead shielding thickness- 1.0" (2.54 cm)

Specifications:

- Dimensions: 20 1/4" h x 14" w x 14" d (51 x 35.5 x 35.5 cm)
- Lead Glass Density: 8" x 8" x 4" (20.32 x 20.32 x 10.16 cm) 5.2 g/cc
- Weight: 195 lb (89 kg)

0665-2014 PET L-Block Shield with 4" Glass

Related:

- 5530-1029** Unpainted Chevron Brick Kit
12" h x 28" w x 16" d x 2" thick (41 x 71 x 30 x 5 cm)
- 5530-1030** Painted Chevron Brick Kit
12" h x 28" w x 16" d x 2" thick (41 x 71 x 30 x 5 cm)

Shielding & Storage



511 Stainless Steel "L" Shield

Offers excellent protection from beta and gamma radiation

This shield is designed for facilities that prepare and dispense high activity 131 therapy doses. The shield offers excellent protection from beta and gamma radiation and has a fully shielded floor. The lead glass is 3.5" thick to shield out the high energy gamma photons from this radionuclide.

Specifications:

- Dimensions: 17.64" h x 13.78" w x 12.2" d (44.8 x 35 x 40 cm)
- Lead Thickness: 1.42" (3.6 cm)
11.61" w x 8.98" h (29.5 x 22.8 cm) x 2.68Tk 4.7 g/cm³ density lead glass
- Weight: 227 lb (102.9 kg)

0550-0003 511 Stainless Steel "L" Block



Standard "L" Block Shield

Favorite as a drawing station

The Standard "L" Shield is the favorite as a drawing station and as a storage shield for unit doses with easy access. Side shields or lead brick may be used to form walls when the Standard Shield is used to store higher activity or for additional shielding. Capintec offers shields with lead greater than the standard 1/2" when working with afterloaders or PET products.

Features:

- .25" lead glass
- .5" lead shielding
- Optional Side Shield .25"
- Additional .25" Lead Glass
- Additional .25" plain glass

Specifications:

- Dimensions: 26" h x 18.5" w x 18.5" d (66 x 47 x 47 cm)
- Weight: 100 lb (45.35 kg)
- The lead glass of the Standard L Block Shield is 1/4" thick, which is equivalent to 1/16 inches of lead thickness
- Density of lead is 11.34 g/cm³

5130-2090 Standard "L" Shield

Related:

1000-0211 Additional Lead Glass for Standard
7310-1305 Side Shields for Standard "L" Shield

Shielding & Storage



Mini "L" Block Shield

Greatest in flexibility of positioning

The Mini "L" Shield offers the greatest in flexibility of positioning. This smaller unit is perfect for those very small work areas where additional protection is required for temporary storage of syringes or vials. Excellent for remote stations where syringes must be filled or as an additional work station.

Features:

- .25" Lead Glass
- .5" Lead Shielding
- Additional .25" Lead Glass
- Additional .25" Plain Glass
- Optional Side Shielding .25"

Specifications:

- Dimensions: 16.75" h x 12" w x 12" d (42.5 x 30.5 x 30.5 cm)
- Weight: 35 lb (15.87 kg)

5130-2086 Mini "L" Shield

Replacement:

- 1000-0207** Additional Lead Glass for Mini "L" Shield
- 1000-0208** Additional Plain Glass for Mini "L" Shield
- 7310-1302** Side Shields for Mini "L" Shield



Stainless Steel "L" Shield

Specially designed to protect staff 99m members working with Tc isotopes

The Tech L-Block Shield is specially designed to protect staff 99m members working with Tc isotopes. This lead-containing L-Block Shield gives full protection to the technologist's torso while the leaded glass window allows the technologist full view of the work area and offers shielding from radiation. This is an excellent product for facilities that compound significant 99m quantities of Tc based radiopharmaceuticals.

Features:

- .59" (1.5 cm) lead glass
- Lead glass density of 4.77 g/cm³
- Lead thickness of .24" (.6 cm) front and bottom

Specifications:

- Dimensions: 15.16" h x 10.43" w x 10.08" d (38.5 x 26.5 x 25.6 cm)
- Weight: 40 lb (18.1 kg)

5550-0002 Stainless Steel "L" Shield

Shielding & Storage



Beta Gamma "L" Block Shield

For facilities that use both beta emitting and gamma emitting nuclides

Manufactured by Capintec for facilities that use both beta emitting and gamma emitting nuclides.

Features:

- Utilizes all the specifications and features of the Standard "L" block, with a 1/4" acrylic plastic interior "L" Shield
- Two shields in one (Beta/Gamma)
- Avoid the hassle of switching out "L" blocks

Specifications:

- Dimensions: 15.75" w x 15.5" d x 13" h
- Weight: 100 lb (45.35 kg)
- The lead glass of the Standard L Block shield is 1/4" thick, which is equivalent to 1/16 mm of lead thickness
- Density of lead is 11.34 g/cm³



Clear-Pb "L" Block Shield

Offers protection from low energy gamma and beta radiation

This Clear-Pb table top "L" shield offers protection from low energy gamma and beta radiation while providing complete visibility of the work area. The truly portable shield is rugged, shatter-resistant and is made from a lead impregnated polymer providing full working accessibility plus full protection of your face and upper body. The Clear-Pb Shields are offered as a Mini 12" h x 9" w, Standard 18" h x 12" w, or Jumbo 24" h x 18" w sizes.

Features:

- Totally clear and distortion-free for easy viewing
- Provides 1.5 mm lead equivalency
- Portable for use in many areas

Specifications:

- Dimensions: 9" w x 12" h (230 x 305 mm)

Nuclide	Attenuation
I-125	99.9%
Xe-133	97.6%
Co-57	99.8%
Tc-99	98%
123	99.5%
Ga-67	67%

5130-2090 Standard "L" Shield
5130-2161 Beta Shield Insert

5730-0031 Standard Clear Pb "L" Shield
5730-0033 Mini-Clear-Pb "L" Shield
5730-0032 Jumbo Clear Pb "L" Shield

Shielding & Storage



for
PET

Chevron Interlocking Lead Brick

For the best protection — Chevron Brick

The flat surface of rectangular lead brick gives good protection. But for maximum protection, we offer interlocking chevron bricks. Their V-shaped edges allow safe and easy stacking to form a walled enclosure, thus minimizing the chance of collapsing. Capintec offers several sizes and thicknesses as well as end and corner brick to meet your particular requirements.

Features:

- Homogeneous and void free
- V-shaped (chevron) allowing no open joints
- Unlimited configurations

Specifications:

7410-0023 Standard

- Dimensions: 2" x 4" x 4" (5 x 10.1 x 10.1 cm x 6 kg)
- Weight: 13.2 lb (5.98 kg)

7410-0024 Base

- Dimensions: 2" x 4" x 4" 1(5 x 10.1 x 10.1 cm x 6.7 kg)
- Weight: 4.9 lb (2.22 kg)

7410-0025 Top

- Dimensions: 2" x 4" x 2" (5 x 10.1 x 5 cm x 2.8 kg)
- Weight: 6.23 lb (2.82 kg)

7410-0023 Standard, Chevron Interlocking Lead Bricks
7410-0024 Base, Chevron Interlocking Lead Bricks
7410-0025 Top, Chevron Interlocking Lead Bricks

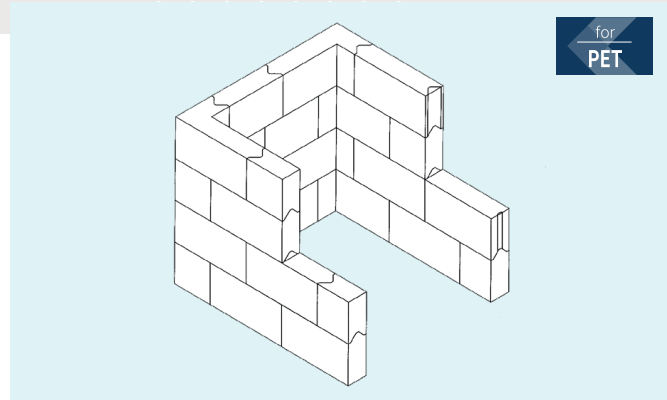

for
PET

Interlocking Lead Brick Caves

Select a 3-walled cave or design your own

The optional Lead Brick Caves fit neatly in the sides of the vertical section to provide lateral shielding around the perimeter of the L-Block's base. For hot labs in mobile vans, the optional Brick Cave Cover will prevent the cave from shifting when the vehicle is in motion.

Specifications:

042-434 Interlocking Lead Brick Cave

- Dimensions:
I.D.: 14" w x 20.5" depth x 16" h (35 x 52.1 x 40.6 cm)
- Lead Shielding: 2" thick (5 cm)
- Finish: Paint
- Weight: 597 lb (271 kg)

5530-2074 3 Walled Brick Enclosure

- Dimensions:
I.D.: 12" h x 20" w x 20" d (30.5 x 50.8 x 50.8 cm)
- Lead Shielding: 2" (5 cm) lead
- Weight: 475 lb (215.4 kg)

5530-1030 3 Walled Brick Enclosure

- Dimensions:
I.D.: 12" h x 28" w x 16" d (30.5 x 71.1 x 40.6 cm)
- Lead Shielding: 2" (5 cm) lead
- Weight: 550 lb (249.4 kg)

042-434 Lead Brick Cave, 3-wall, 2" lead
Fits 042-433 L-Block Shield

5530-2074 3-wall Brick Enclosure 2" lead

5530-1030 3-wall Brick Enclosure 2" lead

Related:

042-435 Lead Brick Cave Cover
Fits 042-434 Lead Brick Cave

Shielding & Storage



Mobile Radiation Shield

The Compact Adjustable Height Radiation Shield is a versatile addition to any PET site. The 1" thick lead panel is 22" w x 19" h. The panel can be height adjusted within a 10" range. The shield can be used to protect technologists from sitting or lying "hot" patients. A fold down shelf is conveniently located to hold syringe shields, carriers and injectors, etc. Place shielding where and when it is needed. Wheel and swivel locks on each caster provide secure placement.

Specifications:

- Dimensions:
24" w x 24.25" deep x 32.5" h (61 x 62 x 83 cm)
Shield: 22" w x 19" h (56 x 48 cm)
Folding Shelf: 24" w x 5" deep (61 x 12.7 cm)
Height Adjustable: 35" to 45" (89 to 114 cm)
- Lead Shielding: 1" thick (2.5 cm)
- Finish: Powder coat
- Weight: 230 lb (104 kg)
- Shipping Weight: 366 lb (166 kg)
- Warranty: One year parts and labor

042-522 Radiation Shield, Mobile, Adjustable Height, Compact, 1" lead



Mobile Radiation Shield

The Adjustable Height Mobile Radiation Shield puts shielding where it is needed. Roll into place, secure the wheels and adjust to the desired height. Panel can be height adjusted within a 4.5" range. Wheel and swivel locks on each caster provide secure placement.

Specifications:

- Dimensions:
37.75" w x 29" depth x 40.5" h (95.9 x 73.7 x 102.9 cm)
Shield: 36" w x 19" h (91.4 x 48.3 cm)
Height Adjustable: 36" to 40.5" (91.4 to 103 cm)
- Lead Shielding: 1" thick (2.5 cm)
- Finish: Powder coat
- Weight: 446 lb (202.3 kg)
- Shipping Weight: 560 lb (254 kg)
- Warranty: One year parts and labor

042-519 Radiation Shield, Mobile, Adjustable Height, 1" lead

Shielding & Storage

Clear-Lead™ Mobile Nuclear Medicine Barrier

Ideal for use during nuclear medicine procedures, the Clear-Lead Mobile Radiation Barrier provides complete protection against patient-emitted radiation. Safe, durable and shatter resistant, the Clear-Lead window is a transparent acrylic containing 30% lead by weight.

Features:

- 1.0 mm lead equivalent protection
- Features 48" x 19.5" Clear-Lead viewing area
- Lightweight, with hand-shaped edges for easy maneuvering and cleaning

Specifications:

- Dimensions:
 - Overall: 51.12" w x 61.25" h (130 x 155.5 cm)
 - Window: 48" w x 19.5" h (122 x 49.5 cm)
 - Opaque Panel: 48" w x 36.5" h (122 x 92.7 cm)
 - Shielding Area: 48" w x 56" h (122 x 142.3 cm)
- Shielding:
 - Window: 1.0 mm lead equivalency
 - Opaque Panel: 1.1 mm lead
- Leg Depth: 10.5" (26.7 cm)
- Casters: Four hospital grade, locking
- Weight: 151 lb (68 kg)
- Warranty: One year parts and labor



042-585

Barrier, Mobile, Clear-Lead, Wide Window
For patient-emitting radiation, 1.0 mm LE
Window size 48" w x 19.5" h

Shielding & Storage



Steel Table

Sturdy as they come, this steel table can be used for just about any application requiring a strong, level platform. Ideal for holding heavy L-Block shields and caves, the surface is powder coated and the front legs feature adjustable levelers. Use the middle shelf to hold small items and the bottom shelf to support shipping containers or other large objects.

Features:

- Strong and sturdy
- Ideal for L-Block Shields and Lead Brick Caves
- Use in PET, nuclear medicine or radiation therapy departments
- Upper and lower shelf to accommodate small and large items, including PET shipping containers

Specifications:

- Dimensions: 36.75" w x 24" depth x 36" h (93.5 x 61 x 91.5 cm)
- Front legs incorporate adjustable levelers
- Finish: Powder coat
- Weight Capacity: 1550 lb (730 kg)
- Weight: 200 lb (90.9 kg)
- Shipping Weight: 254 lb (116 kg)



Lead Glass Goggles

Designed to reduce radiation exposure to the eyes, these lead glass goggles are framed with soft, pliable vinyl and held on the head securely by an adjustable strap. Vents top and bottom of goggles to help prevent fogging. Eye shielding is provided by a 2" x 4.25" single sheet of fluoroscopic quality lead glass. The 4.2 density glass will effectively eliminate more than 95% of direct radiation produced by gamma rays. Glass provides 2.00 mm lead equivalency.

042-407 Table, Steel

117-425 Goggles, Lead Glass

Shielding & Storage



Radiation Resistant Gloves

Designed to reduce scattered beam radiation exposure in any fluoroscopic procedure

Attenuating Gloves are designed to reduce scattered beam radiation exposure in any fluoroscopic procedure. At a nominal 9 mils in thickness, Attenuating Gloves offer excellent flexibility, dexterity, and tactile sensitivity. The thinness also helps reduce finger fatigue. Composed of a lead-free, latex-free, powder-free, Synthetic Neoprene Rubber and Bismuth Trioxide.

The gloves are sterile and offer the following direct attenuation rates.
 57% at 60 kVp
 47% at 80 kVp
 40% at 100 kVp

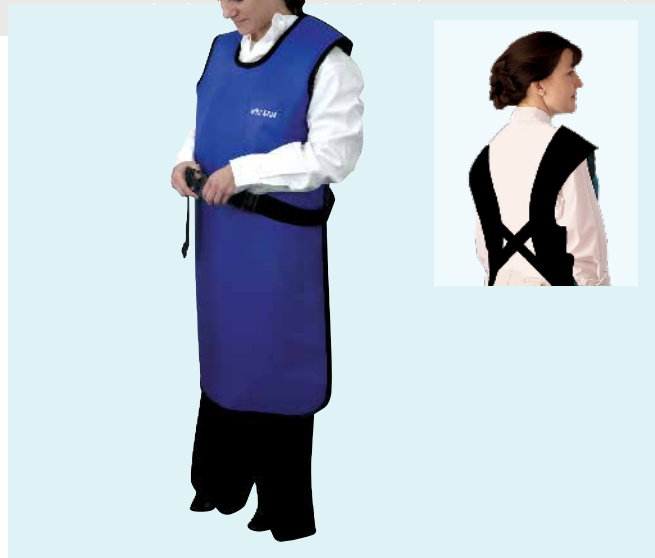

Sof-Skin Coat Apron

This comfortable, supple, protective apron is a pleasure to wear. The lead vinyl core is totally sealed in a tough, easy-to-clean, chemical, abrasion and aging resistant outer covering that is more pliable and lighter than standard lead rubber aprons.

The apron design differs from conventional aprons. There are no straps or buckles for support. Instead the apron is supported across the breadth of the shoulders, held snugly in any position the wearer assumes with the closures. The contour conforming principles assure the wearer of comfort and protection at all times.

Specifications:

- Dimensions: 36" l x 24" w (91.4 x 61 cm)
- Lead Equivalency: 0.5 mm
- Color: Royal Blue (09)
- Weight: 10 lb (4.6 kg)

0680-0016 Radiation Resistant Gloves, size 7 1/2
0680-0017 Radiation Resistant Gloves, size 8
0680-0018 Radiation Resistant Gloves, size 8 1/2

103-701 Apron, Sof-Skin Coat
0680-0013 Thyroid Collar (Removable)

Customize Your Lab for Safety and Efficiency

Lead-Lined Laboratory Furniture

Versatile. Safe. Modular. Secure.

Designed specifically for practical, secure storage of radioactive inventory, the Lead-Lined Laboratory Furniture can be configured to meet your storage, decay and workbench requirements.

- Install units individually, or in any combination
- Cabinets support up to 1500 lb
- Fully encased in steel - no exposed lead
- Includes key-lock doors and brackets for seismic anchoring



CAPINTEC
A MIRION MEDICAL COMPANY

LAB SUPPLIES

Lead-Lined Cabinets & Enclosures

Lead-Lined PET Unit Dose Cabinet

Designed for PET hot labs with limited space, the PET Unit Dose Cabinet provides a space-efficient work area over a fully shielded storage cabinet.

The cabinet requires the 042-433 Compact L-Block with Built-in Dose Calibrator Shield, the 039-412 Sharps Container Shield, the 042-434 Lead Brick Cave, and accommodates all of our Atomlab Dose Calibrators and many others. The dose calibrator display unit mounts on a stand above the countertop to maximize work space.

The lower cabinet has key-locking doors, two sliding bottom shelves, and two sliding upper shelves. The bottom shelves will accommodate PET shipping containers. The top shelves conveniently store syringes, syringe shields, and other small items. This cabinet is completely shielded on all six sides with .25", .5" and 1" lead, and can stand alone or be grouped with other cabinets.

All cabinets in this product line are built to the industry standard height of 36.5". All units include a stainless steel countertop incorporating a 0.5" lip and 4" backsplash. When ordering multiple units for grouped configuration, a unified countertop may be ordered to provide a continuous work surface.

Upon request, we will factory mount* the L-Block and Sharps Shield in place eliminating the need for on-site lifting equipment. A simple pallet jack is all that is required to move the unit.

Features:

- Designed for PET hot labs with limited space
- Accommodates:
 - Compact L-Block Shield with Built-in Dose Calibrator Shield
 - PET Sharps Container Shield
 - Lead Brick Cave
 - CRC® Dose Calibrators and most others
- Sliding shelves for:
 - PET shipping containers
 - Small items
- Lead shielded on all six sides
- Key-locked doors

Specifications:

- Dimensions: 36.5" w x 24" depth x 36.5" h (93 x 61 x 93 cm)
- Lead Shielding: .25" thick (.64 cm)
- Finish: Powder coat
- Doors: Key-locked
- Countertop: Stainless steel with 4" (10.2 cm) backsplash and .5" (1.3 cm) lip
- Weight Capacity: 1550 lb (703 kg)
- Weight: 1240 lb (562 kg)

*Offer applies to the Continental United States only.



- 244-200** Cabinet, PET, Unit Dose, .25" lead
Does not accommodate Lead Brick Cave
- 244-205** Cabinet, PET, Unit Dose, .25" lead
Accommodates Lead Brick Cave 042-434

Related:

- 042-433** L-Block Shield, Compact, 1.5" lead
With built-in Dose Calibrator Shield
- 042-434** Lead Brick Cave, 3-wall, 2" lead
Fits 042-433 L-Block Shield.
- 5130-3235** CRC®-55t PET Dose Calibrator
- 0660-0042** PET Sharps Inserts
Fits 5730-2271
- 5730-2271** PET Sharps Container Shield

Note: The cabinet is also available with .5" and 1" lead shielding. Call for quote.

Lead-Lined Cabinets & Enclosures



Lead-Lined Radioisotope Storage Cabinet

The Radioisotope Storage Cabinet is designed for safely storing radioactive materials. It features 12 key-locked drawers. Each drawer is easily removed for cleaning or decontamination. A card slot identifies contents.

Specifications:

- Dimensions: 30.5" w x 24" depth x 36.5" h (77.5 x 61 x 92.7 cm)
- Lead Shielding: .25" (.64 cm), .5" (1.3 cm) or 1" (2.5 cm) thick on all six sides
- Drawer Dimensions: I.D.: 6" w x 11.88" depth x 4.5" h (15.2 x 30.2 x 11.4 cm)
- Drawers: Key-locked
- Countertop: Stainless steel with 4" (10.2 cm) backsplash and .5" (1.3 cm) spillproof lip
- Finish: Powder coat
- Weight:
 - 244-110: 1069 lb (486 kg)
 - 244-111: 1415 lb (642 kg)
 - 244-112: 2558 lb (1160 kg)

- 244-110** Cabinet, Radioisotope Storage, .25" lead
- 244-111** Cabinet, Radioisotope Storage, .5" lead
- 244-112** Cabinet, Radioisotope Storage, 1" lead



Lead-Lined Decay Cabinet

The Decay Cabinet is designed for long and short-term storage of decaying radioactive material. Two adjustable shelves support up to 100 lb each. The door is key-locked to prevent unauthorized access. The cabinet will accommodate sharps containers and other boxed waste prior to disposal. It can also be used to store flood sources.

Specifications:

- Dimensions: 30.5" w x 24" depth x 36.5" h (77.5 x 61 x 92.7 cm)
- Lead Shielding: .25" (.64 cm), .5" (1.3 cm) or 1" (2.5 cm) thick on all six sides
- Shelf Dimensions: 24.25" w x 18" depth (61.5 x 45.7 cm), 100 lb (45.4 kg) capacity, adjustable height
- Door: Key-locked
- Countertop: Stainless steel with 4" (10.2 cm) backsplash and .5" (1.3 cm) spillproof lip
- Finish: Powder coat
- Weight:
 - 244-140: 1010 lb (458 kg)
 - 244-141: 1267 lb (575 kg)
 - 244-142: 2125 lb (964 kg)

- 244-140** Cabinet, Decay, .25" lead
- 244-141** Cabinet, Decay, .5" lead
- 244-142** Cabinet, Decay, 1" lead

*Note: Reverse door swing available.
Call for quote.*

Lead-Lined Cabinets & Enclosures



Lead-Lined Preparation Enclosure Base Cabinet

This Cabinet is designed to support the Lead-Lined Preparation Enclosure. Full height, overlapping double doors with key locks open to an adjustable shelf with a 100 lb capacity. The cabinet may be used for decay and storage.

Specifications:

- Dimensions: 36.5" w x 24" depth x 36.5" h (92.7 x 61 x 92.7 cm)
- Lead Shielding: .25" (.64 cm), .5" (1.3 cm) or 1" (2.5 cm) thick on all six sides
- Shelf Dimensions: 30" w x 18" depth (76.2 x 45.72 cm), 100 lb (45.4 kg) capacity, adjustable height
- Doors: Key-locked
- Countertop: Stainless steel with 4" (10.2 cm) backsplash and .5" (1.3 cm) spillproof lip
- Finish: Powder coat
- Weight:
 - 244-190: 1063 lb (483.2 kg)
 - 244-191: 1540 lb (699 kg)
 - 244-192: 2433 lb (1104 kg)

- 244-190** Cabinet, Preparation Enclosure Base, .25" lead
- 244-191** Cabinet, Preparation Enclosure Base, .5" lead
- 244-192** Cabinet, Preparation Enclosure Base, 1" lead

Related:
244-007 Preparation Enclosure, .25" lead, 115 V



Adjustable 12" shield can fold forward to load large objects. The hood can also be completely closed and used for storage. Preparation Enclosure features built-in electrical outlets.

Lead-Lined Preparation Enclosure

The Lead-Lined Preparation Enclosure is designed for applications that require handling gaseous radioactive materials. The interior provides ample floor space. A large lead glass window and halogen light allow safe and unobstructed viewing. The enclosure opening has an adjustable shield that creates access ports. A swing down shield covers the ports when not in use.

Gaseous materials are directed by a baffle (eliminating dead space) through a stainless steel chimney. The chimney is connected to external blowers (not supplied) and ductwork (not supplied). The blowers create a negative pressure preventing gas leaks.

Specifications:

- Dimensions: 36" w x 24" depth x 30.5" h (91.4 x 61 x 77.5 cm)
Interior Floor Space: 31" w x 19" depth (78.7 x 48.3 cm)
- Lead Shielding: .25" thick (.64 cm)
- Adjustable Shield: 12" w x 10" h x .5" thick (30.5 x 25.4 x 1.3 cm)
- Exhaust: 6" dia (15.2 cm) chimney, fixed upper and adjustable lower baffles. Blower and filter not included
- Lighting: Halogen lamp with two 25 watt bulbs, UL listed.
- Lead Glass Window:
Dimensions: 34.5" w x 11.8" h x .75" thick (87.6 x 30 x 1.9 cm)
Density: 5.05 g/cm³
- Finish: # 3 brushed, stainless steel
- Weight: 733 lb (332 kg)

- 244-007** Preparation Enclosure, .25" lead, 115 V
- 244-008** Preparation Enclosure, .25" lead, 230 V

Related:
244-190 Cabinet, Preparation Enclosure Base, .25" lead
244-191 Cabinet, Preparation Enclosure Base, .5" lead
244-192 Cabinet, Preparation Enclosure Base, 1" lead

Lead-Lined Cabinets & Enclosures



Lead-Lined Decay and Storage Cabinet

The Decay and Storage Cabinet performs two functions. Radioisotopes can be safely stored in drawers, while the cupboard section is for the storage of decaying material.

Drawers are easily removed for cleaning and decontamination. The decay section includes two heavy duty adjustable shelves.

Specifications:

- Dimensions: 36.5" w x 24" depth x 36.5" h (92.7 x 61 x 92.7 cm)
- Lead Shielding: .25" (.64 cm), .5" (1.3 cm) or 1" (2.5 cm) thick on all six sides
- Drawer Dimensions: I.D.: 6" w x 11.88" depth x 4.5" h (15.2 x 30.2 x 11.4 cm)
- Shelf Dimensions: 22" w x 18" depth (55.9 x 45.7 cm)
- Door and Drawers: Key-locked
- Countertop: Stainless steel with 4" (10.2 cm) backsplash and .5" (1.3 cm) spillproof lip
- Finish: Powder coat
- Weight:
 - 244-160: 1103 lb (501.4 kg)
 - 244-161: 1421 lb (645 kg)
 - 244-162: 2500 lb (1134 kg)

244-160	Cabinet, Decay and Storage, .25" lead
244-161	Cabinet, Decay and Storage, .5" lead
244-162	Cabinet, Decay and Storage, 1" lead



Lead-Lined Waste Cabinet

The Waste Cabinet is designed for storing "non-sharps" radioactive waste. A spacious chute with shielded cover allows waste to be dropped directly into a polyethylene container prior to decay and disposal.

Specifications:

- Dimensions: 30.5" w x 24" depth x 36.5" h (77.5 x 61 x 92.7 cm)
- Lead Shielding: .25" (.64 cm), .5" (1.3 cm) or 1" (2.5 cm) thick on all six sides
- Chute: 6.5" dia. (16.5 cm) with .5" thick (1.3 cm) lead shielded cover
- Container: 22" h x 17" dia. (56 x 43 cm) polyethylene, 16 gal capacity
- Door: Key-locked
- Countertop: Stainless steel with 4" (10.2 cm) backsplash and .5" (1.3 cm) spillproof lip
- Finish: Powder coat
- Weight:
 - 244-150: 913 lb (415 kg)
 - 244-151: 1282 lb (583 kg)
 - 244-152: 2290 lb (1039 kg)

244-150	Cabinet, Waste, .25" lead
244-151	Cabinet, Waste, .5" lead
244-152	Cabinet, Waste, 1" lead

*Note: Reverse door swing available.
Call for quote.*

Lead-Lined Cabinets & Enclosures



Lead-Lined Waste and Storage Cabinet

The Waste and Storage Cabinet performs two functions. Radioisotopes can safely be stored in drawers, while the cupboard section is for the storage of "non-sharps" radioactive waste.

Drawers are easily removed for decontamination. The cupboard section includes a shielded port and a 16 gallon polyethylene container.

Specifications:

- Dimensions: 36.5" w x 24" depth x 36.5" h (92.7 x 61 x 92.7 cm)
- Lead Shielding: .25" (.64 cm), .5" (1.3 cm) or 1" (2.5 cm) thick on all six sides
- Drawer Dimensions: I.D.: 6" w x 11.88" depth x 4.5" h (15.2 x 30.2 x 11.4 cm)
- Waste Section:
 - Chute: 6.5" dia. (16.5 cm) with .5" thick (1.3 cm) lead shielded cover
 - Container: I.D.: 22" h x 17" dia. (56 x 43 cm) polyethylene, 16 gal capacity
- Door and Drawers: Key-locked
- Countertop: Stainless steel with 4" (10.2 cm) backsplash and .5" (1.3 cm) spillproof lip
- Finish: Powder coat
- Weight:
 - 244-170: 863 lb (391 kg)
 - 244-171: 1439 lb (653 kg)
 - 244-172: 2462 lb (1117 kg)

244-170	Cabinet, Waste and Storage, .25" lead
244-171	Cabinet, Waste and Storage, .5" lead
244-172	Cabinet, Waste and Storage, 1" lead



Lead-Lined Sink and Waste Cabinet

The Sink and Waste Cabinet performs three functions. A stainless steel sink allows the convenience of running water in the hot lab. The space under the sink is used for cold storage. Separated from the sink section by a lead barrier, the waste section includes a shielded port that allows waste to be dropped into a polyethylene container for storage until decayed.

Specifications:

- Dimensions: 30.5" w x 24" depth x 36.5" h (77.5 x 61 x 92.7 cm)
- Lead Shielding: .25" (.64 cm), .5" (1.3 cm) or 1" (2.5 cm) thick on all six sides
- Sink Section: 10" w x 14" depth x 10" h (25.4 x 35.6 x 25.4 cm) Integral stainless steel sink with gooseneck faucet and wrist blades; suitable for cold storage
- Waste Section:
 - Chute: 6.5" dia. (16.5 cm) with .5" thick (1.3 cm) lead shielded cover
 - Container: I.D.: 20.5" h x 11.25" dia. (52 x 28.6 cm), polyethylene, 7 gal capacity
- Door: Key-locked
- Countertop: Stainless steel with 4" (10.2 cm) backsplash and .5" (1.3 cm) spillproof lip
- Finish: Powder coat
- Weight:
 - 244-130: 849 lb (386 kg)
 - 244-131: 1253 lb (569.5 kg)
 - 244-132: 2260 lb (1027.3 kg)

244-130	Cabinet, Sink and Waste, .25" lead
244-131	Cabinet, Sink and Waste, .5" lead
244-132	Cabinet, Sink and Waste, 1" lead

Notes: Reverse door swing available.
Call for quote.

Lead-Lined Cabinets & Enclosures



Larger generator drawer will accommodate the Mallinckrodt Generator with Elution Shield.

Lead-Lined Generator and Storage Cabinet

The Generator and Storage Cabinet provides hot lab radiation protection without hampering the elution process. The left drawer accommodates top or side loading generators. In addition to the .5" or 1" lead shielding in front, the drawer has .25" lead shielding on the remaining three sides and bottom. A removable drawer top allows generator replacement. Trap doors on the top and sides of this drawer provide safe access to the generator. The cabinet has two shielded compartments on the right side for storing decaying generators prior to disposal.

Specifications:

- Dimensions: 36.5" w x 24" depth x 36.5" h (92.7 x 61 x 92.7 cm)
- Lead Shielding:
 - Cabinet: .5" (1.3 cm) or 1" (2.5 cm) thick on all six sides
 - Drawer: .25" thick (.64 cm) on five sides
 - Dividers: .5" thick (1.3 cm)
- Drawer Dimensions: I.D.: 15.5" w x 11.9" depth x 18.2" h (39.4 x 30.2 x 46.2 cm)
- Doors and Drawer: Key-locked
- Countertop: Stainless steel with 4" (10.2 cm) backsplash and .5" (1.3 cm) spillproof lip
- Finish: Powder coat
- Weight:
 - 244-181: 1917 lb (869.5 kg)
 - 244-182: 2815 lb (1277 kg)

244-181	Cabinet, Generator and Storage, .5" lead
244-182	Cabinet, Generator and Storage, 1" lead

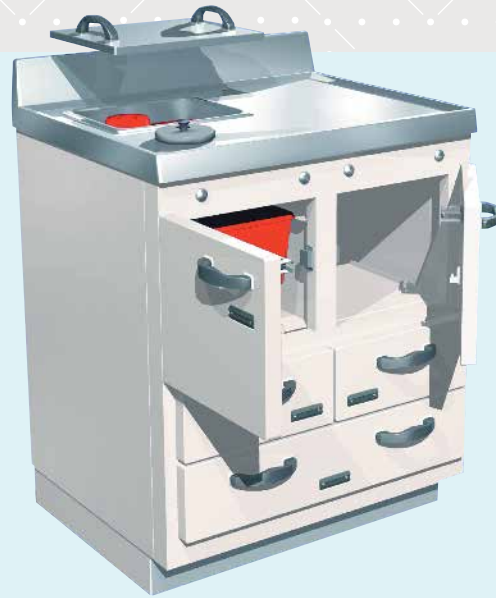

Lead-Lined Unit Dose Cabinet

The Unit Dose Cabinet is designed for hot labs with limited space. The upper left compartment holds two sharps containers to facilitate decay rotation. Dispose syringes in the front container through a small chute. A large rear port allows safe removal of the second decayed container. Shielded doors on storage cabinets provide access to bulk unit dose ammo boxes without additional exposure. Side-by-side middle drawers can be used for storage of syringes, sources, pigs, radioisotopes and other small items requiring lead shielding.

Phantoms and flood sources can be stored in the bottom drawer which runs the full width of the cabinet.

Specifications:

- Dimensions: 30.5" w x 24" depth x 36.5" h (77.5 x 61 x 92.7 cm)
- Lead Shielding: .25" (.64 cm), .5" (1.3 cm) or 1" (2.5 cm) thick on all six sides
- Drawer Dimensions:
 - Bottom Drawer: I.D.: 23.5" w x 21.8" depth x 4.5" h (59.7 x 55.4 x 11.4 cm)
 - Left & Right Drawers: I.D.: 9.38" w x 17.88" depth x 4.5" h (23.8 x 45.4 x 11.4 cm)
 - Upper Doors: I.D.: 11.5" w x 17.62" depth x 11" h (29.2 x 44.7 x 27.9 cm)
- Doors and Drawers: Key-locked
- Countertop: Stainless steel with 4" (10.2 cm) backsplash and .5" (1.3 cm) spillproof lip
- Finish: Powder coat
- Weight:
 - 244-120: 1156 lb (524.3 kg)
 - 244-121: 1614 lb (732 kg)
 - 244-122: 2328 lb (1056 kg)

244-120	Cabinet, Unit Dose, .25" lead
244-121	Cabinet, Unit Dose, .5" lead
244-122	Cabinet, Unit Dose, 1" lead

Lead-Lined Cabinets & Enclosures



Shown with Decay Module

Lead-Lined Phantom Cabinet

The Phantom Cabinet stores flood sources and phantoms* on their ends. The interior is sectioned by an adjustable divider. The Lead-Lined Phantom Cabinet cannot be ordered separately, it must be part of a multiple cabinet configuration.

Specifications:

- Dimensions: 11.6" w x 24" depth x 36" h (29.5 x 60.9 x 91.4 cm)
- Lead Shielding: .25" thick (.64 cm)
- Door: Key-locked
- Finish: Powder coat
- Weight: 319 lb (145 kg)

*Phantom Cabinet does not accommodate 24" circular phantoms.

244-009 Cabinet, Phantom, .25" lead

Note: Must be ordered as part of a multiple cabinet configuration



Freestanding or under-the-counter unit

Lead-Lined Refrigerator

Our 5.3 cubic foot capacity Lead-Lined Refrigerator is ideal for storing radiopharmaceuticals, tagged biologicals and other radioactive materials. The two adjustable stainless steel shelves allow you to make the most of your refrigerator capacity.

Features:

- Touch pad digital controls
- 5.3 cubic foot capacity
- Automatic defrost
- Energy Star qualified – saves energy, money and natural resources
- Two adjustable stainless steel shelves

Specifications:

- Dimensions: 24.18" w x 25.5" depth x 34.25" h (61 x 64.8 x 87 cm)
- Lead Shielding: .125" thick (.32 cm)
- Capacity: 5.3 cu ft
- Door: Key-locked
- Power:
 - 244-004: 120V, 60 Hz, 1.1 amps
 - 244-005: 230V, 50 Hz, 1.2 amps
- Finish: Powder coat
- Weight: 340 lb (154.5 kg)
- Shipping Weight: 390 lb (177.2 kg)
- Warranty: One year parts and labor

244-004 Refrigerator, Lead-Lined, 120 V
244-005 Refrigerator, Lead-Lined, 230 V

Drawing can be accessed at www.capintec.com

Lead-Lined Cabinets & Enclosures



Lead-Lined Storage Safe

Conveniently loaded from the front, this Storage Safe is ideal for storing large quantities of high-activity radioisotopes. Shielded with a thickness of 2" of lead, the safe is encased in a powder-coated steel jacket and features an adjustable shelf.

The lead-lined door is hung with heavy duty non-sagging hinges and is key-locked to prevent unauthorized access.

Transporting this half-ton safe is made easier with the built-in lifting handles for use with a hoist or other means.

Specifications:

- Dimensions: 17.4" w x 17" depth x 19" h (44.2 x 43.2 x 48.3 cm)
I.D.: 12" w x 12" depth x 12" h (30.5 x 30.5 x 30.5 cm)
- Lead Shielding: 2" thick (5 cm)
- Finish: Powder coat
- Door: Key-locked
- Weight: 1050 lb (476 kg)

244-006 Safe, Storage, 2" lead

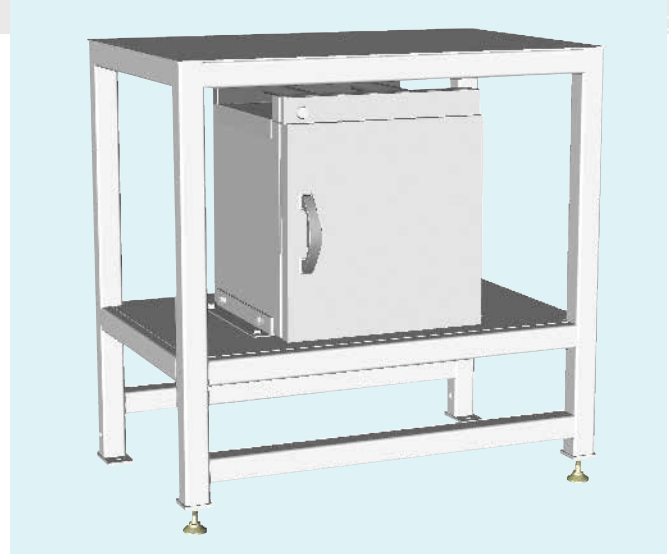

Cyclotron Workbench

This steel table can be used for just about any application requiring a strong, level platform. Ideal for holding heavy L-Block shields and caves, the surface is powder coated and the front legs feature adjustable levelers. The middle shelf features a storage safe that is ideal for storing large quantities of high-energy radioisotopes and/or target decay. Shielded with a thickness of 2" of lead. The safe is encased in a powder-coated steel jacket and features an adjustable shelf. The lead-lined door is hung with heavy duty non-sagging hinges and is key-locked to prevent unauthorized access.

Features:

- Includes 2" lead storage safe
- Ideal for target decay
- Use in PET, nuclear medicine or radiation therapy departments

Specifications:

042-456 Cyclotron Workbench

- Dimensions: 36.75" w x 24" depth x 36" h (93.5 x 61 x 91.5 cm)
- Front legs incorporate adjustable levelers
- Finish: Powder coat
- Weight Capacity: 1600 lb (725.76 kg) includes 1050 lb for safe
- Weight: 1200 lb (544.32 kg)
- Shipping Weight: 1250 lb (567 kg)

244-006 Lead Storage Safe, 2"

- Dimensions: 17.4" w x 17" depth x 19" h (44.2 x 43.2 x 48.3 cm)
I.D.: 12" w x 12" depth x 12" h (30.5 x 30.5 x 30.5 cm)
- Lead Shielding: 2" thick (5 cm)
- Finish: Powder coat
- Door: Key-locked
- Weight: 1050 lb (476 kg)

042-456 Workbench, Cyclotron
Includes: Storage Safe, 2" lead (244-006)

Lead-Lined Cabinets & Enclosures

PET Unit Dose Table

Designed for PET hot labs with limited space, the PET Unit Dose Table includes features to help maximize the work area and the protection.

The compact L-Block with dose calibrator shield features a large 8" x 8" x 4" lead glass window with adjustable window angle, 1.5" thickness lead shielding in front, and 1" thick lead in the base and in the chamber shield. It is designed to accommodate a chamber that is through mounted in the countertop. The chamber shield accommodates Atomlab chambers and many others.

The Sharps Container Shield is constructed of steel and lined with 1" thick lead. It features a lockable sliding cover for container removal and a hinged top door for syringe disposal.

Shipped completely assembled*, the Unit Dose Table eliminates the need for on-site lifting equipment. A simple pallet jack is all that is required to move the unit. Once the dose calibrator chamber is placed in the shield, the chamber support shelf provides 1" thick lead shielding. The dose calibrator display unit mounts on a stand above the countertop to further maximize work space.

A spacious bottom shelf can hold several PET shipping containers. The middle shelf provides convenient storage for syringe shields and other small items.

In applications where additional shielding is required, the optional 042-434 Lead Brick Cave is available.

Features:

- Designed for PET hot labs with limited space
- Lead shielding under calibration chamber
- Shipped Completely Assembled:
 - Compact L-Block Shield with Built-in Dose Calibrator Shield
 - PET Sharps Container Shield
- Shelf space for:
 - PET shipping containers
 - Small items

*Offer applies to Continental United States only



Specifications:

042-448 PET Unit Dose Table:

- Dimensions: 36.75" w x 24" depth x 36" h (93.5 x 61 x 91.5 cm)
Front legs incorporate adjustable levelers.
- Lead Shielding: 1" thick (enclosed in chamber mounting shelf)
- Finish: Powder coat
- Weight Capacity: 1550 lb (703 kg)
- Weight: 294 lb (133.3 kg)

042-433 Compact L-Block with Dose Calibrator Shield:

- Dimensions: 18" w x 21.5" depth x 26" h (45.7 x 54.6 x 66 cm)
- Lead Shielding:
 - Front: 1.5" thick (3.8 cm)
 - Base: 1" thick (2.5 cm)
 - Calibrator Shield: 1" thick (2.5 cm)
- Calibrator Shield Inside Dimensions: 6.85" I. D. x 10.25" h (17.4 x 26 cm)
- Lead Glass Window:
 - Dimensions: 8" w x 8" h x 4" thick (20.3 x 20.3 x 10.2 cm)
 - Density: 5.2 g/cm³
- Finish: Powder coat
- Weight: 590 lb (259 kg)

042-448 Table, PET, Unit Dose
Includes: 042-433 Compact L-Block with
Dose Calibration Shield and
5730-2271 Sharps Container Shield

Related:
042-434 Lead Brick Cave, 3-wall, 2" lead
Fits 042-433 L-Block Shield

5130-2216 CRC®-55tW Dose Calibrator

0660-0042 PET Sharps Inserts
Fits 5730-2271

LAB SUPPLIES

Sources & Markers



FeatherLite™ Cobalt-57 Flood Source*

Improve quality control with superior camera calibration

The FeatherLite Cobalt-57 Rectangular Flood Source weighs up to 60% less than other flood sources. Lower weight means less strain to the back and greater maneuverability. This flood source provides a uniform field of radiation for evaluation of nuclear medicine gamma camera performance, allowing detection and correction of any camera malfunction prior to diagnostic use. The typical useful life of the Co-57 Flood Source is approximately two years. The Co-57 Flood Source meets the standards established by the manufacturers of the gamma cameras.

The flood source is shipped with a lead-lined cardboard container. An optional case is available for the FeatherLite Flood Source.

Features:

- Environmentally safe
- Proprietary Cobalt chemistry
- Delivers superior source uniformity
- Technological innovation

Specifications:

043-861

- Dimensions: 25.2" l x 17.9" w (64 x 45.5 cm)
- Active Dimensions: 23.9" l x 16.4" w (60.7 x 41.6 cm)

Specifications:

0975-8400

- Active Dimensions: 23.9" l x 16.4" w (60 x 41.6 cm)

043-861 Flood Source, Rectangular, 10 mCi
Not available for export.



Radshield case and Rad scooter sold separately.

RadLite™ Cobalt-57 Flood Sources*

The RadLite Cobalt-57 Flood Source is used to test the response uniformity of gamma cameras to ensure camera response is consistent over the total head area(s). Cobalt-57 is uniformly dispersed in an epoxy matrix fully sealed in a high integrity ABS encapsulation. Radionuclide purity is greater than 99.9% (combined Co-56/Co-58 is less than 0.08% at source reference date). The flood sources are supplied with a uniformity test statement, wipe test certificate, handling and storage information and a custom decay calendar.

Features:

- Lightweight, slim design
- Dual head quality control acquisition
- Expiration life up to 24 months

Specifications:

Rectangular Flood Sources

- Dimensions: 24.1" l x 16.7" w x .3" thick (61.2 x 42.4 x .76 cm)
- Active Dimensions: 23.9" l x 16.5" w (61 x 42 cm)

Cardiac Rectangular Flood Source

- Dimensions: 15.8" l x 9.5" w x .3" thick (40.1 x 24.1 x .76 cm)
- Active Dimensions: 15.5" l x 9.25" w (39.4 x 23.5 cm)

- 043-840** Flood Source, Rectangular, 10 mCi
- 043-845** Flood Source, Rectangular, 20 mCi
- 043-860** Flood Source, Cardiac, Rectangular, 10 mCi
Not available for export.

Optional:

- 043-841** Case, Flood Source, Radshield
For 043-840, 043-845 and 043-855
- 043-842** Rad scooter
For 043-840, 043-845 and 043-855

*A photocopy of your NRC or Agreement State License must accompany orders for radioactive sources and must clearly indicate your authority to possess the source being ordered.

Sources & Markers



Reference Standards

Guaranteed accuracy, highest quality and lowest cost in industry

Each "E"-vial reference source comes with a certificate of radioactivity calibration that guarantees accuracy within 5%. If you need a reference source with an activity not listed in this catalog, Capintec can meet your special request promptly. Capintec will arrange for disposal of original source with purchase of replacement source.

Features:

- High-quality sources
- Lowest cost (available)
- Guaranteed accuracy within 5%
- Ensures that your dose calibrator meets NRC/Agreement State QC requirements
- Daily 18-month decay calendar
- Purchase individually or in sets
- Return policy eliminates expense of disposal

0975-0006	Reference Standards, Co-57 vial, 5 mCi
0975-5710	Reference Standards, Co-57 vial, 10 mCi
0975-0002	Reference Standards, Cs-137 vial, 100 µCi
0975-3720	Reference Standards, Cs-137 vial, 200 µCi
0975-3725	Reference Standards, Cs-137 vial, 250 µCi
0975-0003	Reference Standards, Ba-133 vial, 250 µCi
0975-0008	Reference Source Set, Co-57 (5 mCi), Co-60 (100 µCi), Cs-137 (200 µCi), Ba-133 (250 µCi)



Dose Calibrator Syringe Vial Reference Sources*

The daily calibration of dose calibrators is recommended to ensure accurate and reproducible instrument response. Calibration is easily achieved and maintained by the use of long-lived reference sources. These sources are solid cast epoxy, 20 ml active volume in the 27 ml Vial E. They are calibrated with $\pm 5\%$ accuracy at the 99% confidence level, NIST traceable. Dose Calibrator Reference Sources are registered with the U.S. Food and Drug Administration Center for Devices and Radiological Health and the U.S. Nuclear Regulatory Commission. Each source includes a certificate of calibration, a leak test certificate, and a radiation safety and handling sheet. The source is packaged in an individual lead shield that is color coded and vinyl covered to eliminate exposure to the lead. Dose Calibrator Reference Sources are available individually or as an economical set.

**A photocopy of your NRC or Agreement State License must accompany orders for radioactive sources and must clearly indicate your authority to possess the source being ordered.*

<i>All sources calibrated to $\pm 5\%$</i>	
063-562	Source, Ba-133, 250 µCi
101-356	Source, Cs-137, 200 µCi
063-261	Source, Co-57 simulated Tc-99m, 5 mCi
063-720	Source, Co-57 simulated Tc-99m, 10 mCi
063-586	Reference Source Set
	<i>Set includes: Co-57, 5 mCi; Cs-137, 200 µCi; Ba-133, 250 µCi</i>

Not available for export.

Sources & Markers



Dose Calibrator Syringe Reference Sources*

Dose calibration, should be performed in a manner that most closely represents how you use your dose calibrator. The Syringe Reference Source was designed for imaging facilities that obtain their radiopharmaceuticals in unit dose syringes. The sources are solid cast epoxy, 3 ml active volume in a 5 cc mock syringe. They are calibrated within $\pm 5\%$ accuracy at 99% confidence level, NIST traceable. Each source includes a certificate of calibration, leak test certificate, and radiation safety and handling sheet. The source is packaged in an individual lead shield that is color coded to the source.

*A photocopy of your NRC or Agreement State License must accompany orders for radioactive sources and must clearly indicate your authority to possess the source being ordered.

All sources calibrated to $\pm 5\%$
063-362 Source, Co-57, 5 mCi
 Not available for export.

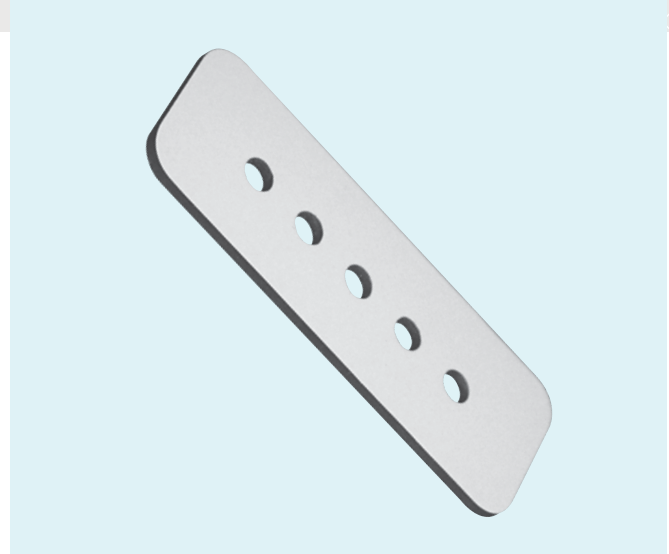

Liver Marker/Ruler

The Liver Marker/Ruler is designed to mark, outline, and measure the liver while performing routine studies. When placed over the area of interest, a measurement is taken by counting the space between holes. The marker is made of vinyl-coated leaded rubber for flexibility and easy cleaning. Each unit is 5.5" long and 2" wide with holes 1 cm apart. Two units are supplied as a kit.

Note: Product contains lead. Handle with gloves and avoid skin contact.

Specifications:

- Dimensions: 5.5" l x 2" w (14 x 5 cm)
- Holes: 0.187" dia. (9 mm)
- Lead Equivalency: 1 mm

123-500 Liver Marker/Ruler

Sources & Markers

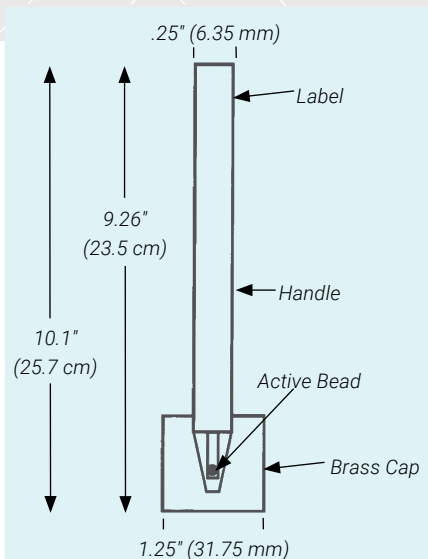

Pen Point Marker Sources*

The Pen Point Marker Source contains Co-57 in a ceramic matrix at the end of a 9.26" (23.5 cm) anodized aluminium rod. The pen-shaped rod screws into a brass cap which shields the active point. The Pen Point Marker Source is used in tracing the outlines of anatomical features on a patient. The trace appears almost instantly on the camera display. Contained activity is supplied as a nominal value $\pm 15\%$.

Specifications:

- Dimensions: 9.26" l x .25" dia. (235 x 6.35 mm)
- Nuclide: Co-57
- Source: 2 mm bead
- Nominal Activity:
063-700 100 μCi
063-701 200 μCi
- Source Cover: Brass cap

063-700 Marker Source, Pen Point, 100 μCi
063-701 Marker Source, Pen Point, 200 μCi
Not available for export.

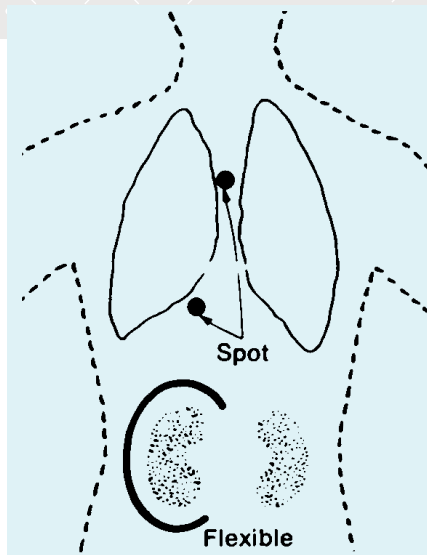

Spot Marker Source*

A Spot Marker Source is easily taped to the patient for purposes of orientation while performing a camera study.

Specifications:

- Dimensions: 1" dia. x .25" thick (25 x 6 mm) clear lucite disk
- Spot: .125" dia. (3 mm)
- Activity:
099-289: 50 μCi
099-291: 100 μCi
0975-S050: 50 μCi
0975-S100: 100 μCi
0975-S200: 200 μCi

099-289 Marker Source, Spot, Co-57, 50 μCi



Fillable Point Marker Source

Marker Sources are easily filled with the same radionuclide to be used in imaging procedures. Small clear plastic receptacle, 1" diameter x .5" thick, has a centered channel to contain 0.2 cc of the nuclide. A nylon screw-plug tightens against an O-ring completing a tight, safe seal. Marker is re-usable or nuclide can be decayed or removed.

Specifications:

- Dimensions: 1" dia. x .5" thick
- Volume: 0.2 cc

043-274 Marker Source, Fillable Point, 4/set

*A photocopy of your NRC or Agreement State License must accompany orders for radioactive sources and must clearly indicate your authority to possess the source being ordered.

Sources & Markers



Rod Sources

These sources are used for calibrating well type NaI detectors. They are constructed of high-strength plastic to withstand the rigors of constant use in a busy department. They have a flat base which allows easy positioning in the vertical position required for consistent accuracy in the counting of many tests.

Capintec Rod Sources are calibrated as NIST traceable with an accuracy of $\pm 5\%$ at the 99% confidence level. Each source consists of a lucite rod measuring

Specifications:

- Dimensions: 5" l x .5" w (12.7 x 1.27 cm)

Lucite Rod

- Dimensions: 2.95" l x .5" w (7.4 x 1.27 cm)
- Active Diameter: 0.187" (9 mm)

0975-152R and 0975-137R

- Nominal Calibration +/-15%

0975-137S and 0975-0025

- Nominal Calibration +/-5%

0975-152R Rod Source, Eu-152, 0.5 μ Ci
0975-137R Rod Source, Cs-137, 0.5 μ Ci
0975-0025 Rod Source, Co-57 37 kBq, 1.0 μ Ci

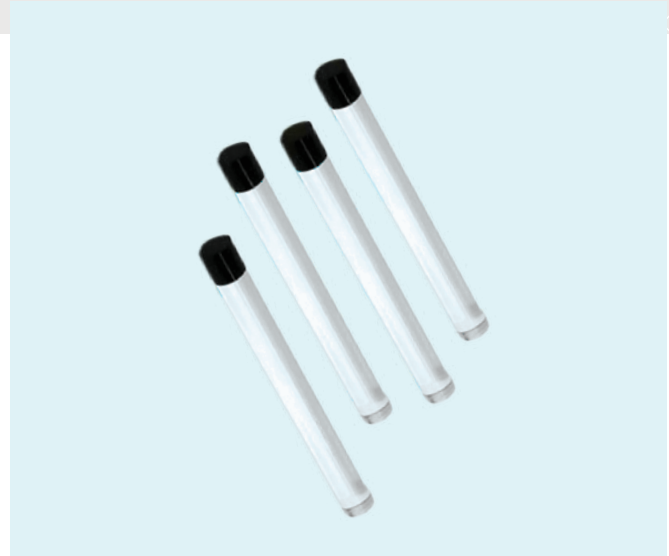

Rod Sources*

To calibrate well type scintillation crystals, we offer a variety of Rod Sources to meet department needs. You can count on consistent accuracy. Rod Sources are calibrated as NIST traceable with an accuracy of $\pm 5\%$ at the 95% confidence level.

Specifications:

- Dimensions: 2.96" l x 0.47" dia.
(76 x 11.9 mm)
- Nominal Total Activity: 0.1 μ Ci

*A photocopy of your NRC or Agreement State License must accompany orders for radioactive sources and must clearly indicate your authority to possess the source being ordered.

063-140 Rod Source, Ge-68 simulated F-18
Not available for export.

Sources & Markers



Check Source*

Instrument functionality is easily assessed with a Cs-137 Check Source. The activity is 10 μ Ci. A license is necessary.

Specifications:

- Dimensions: 1" dia. x .25" thick (2.5 x .64 cm)



Disk Source

Disk Sources are mainly used for checking the performance of GM tubes and NaI detectors. The disk is manufactured of high-strength plastic. The active area is centered in the disk.

Specifications:

- Dimensions: 1" dia. x .25" thick (2.5 x .64 cm)
- Active Diameter: 0.197" (5.0 cm)

*A photocopy of your NRC or Agreement State License must accompany orders for radioactive sources and must clearly indicate your authority to possess the source being ordered.

101-103 Check Source, Cs-137, 10 μ Ci (uncalibrated)
Not available for export.

0975-139X Cs-137 Disk, 0.37 MBq, 10 μ Ci

LAB SUPPLIES

Lab Equipment



Convenient, adjustable and portable for safe injections; includes a Lead-Lined Multi-Syringe Holder for convenient radionuclide injections.

Injection Stand

The Injection Stand allows fast, comfortable arm positioning for radionuclide injections. The clear plastic armrest rotates 180° facilitating convenient angling while the cradle design holds the patient's arm firmly in place. A utility tray sits adjacent to the armrest to place various supplies and includes a shielded Multi-Syringe Holder, which accommodates up to four syringes.

The stand is height adjustable to accommodate patient comfort. Smooth rolling casters allow the stand to roll easily into position or out of the way for storage when not in use. The stand is structurally balanced to help prevent tipping.

Specifications:

- Height Adjustable: 29" h to 44" h (74 to 112 cm)
- Stand Base: 17.5 x 17.5 (44.5 x 44.5 cm)
- Construction: Stable, chrome plated tubular steel
- Shipping Weight: 21 lb (10 kg)



Injection Chair features an easy to clean, one piece plastic drawer. Drawer and arm can be mounted on either side of the chair.

Injection Chair

Designed specifically for injections and blood drawing, this chair is a comfortable solution for patient seating and positioning. The flat surface of the armrest prevents backbending of the elbow and subsequent flattening of the vein. The armrest is height adjustable to accommodate all patient sizes with a knob adjustable double pivot swing arm. The seat itself is one piece of plastic which makes it easy to clean. A stiffener bias limits backrest flexibility to ensure stable seating.

Specifications:

- Dimensions: 23" l x 43" w (58.5 x 109 cm)
- Seat Dimensions: 16" l x 17" w x 20" h (40.6 x 43 x 51 cm)
- Arm Height (adjustable): 27" h to 33" h (69 to 84 cm)
- Width between arms: 20" (51 cm)
- Construction (frame): Heavy steel tubing 1.25" (3 cm) square, with chromed steel uprights for stability
- Weight: 35 lb (15.9 kg)
- Patient Weight Capacity: 250 lb (113.4 kg)

135-022 Stand, Injection

214-220 Chair, Injection with Storage Drawer

Lab Equipment



Chair back and arms fold away from imaging area with the touch of a button.

Imaging Chair

The Imaging Chair puts the patient at ease and provides alternative patient positioning for nuclear medicine procedures. With the back support and armrests in place, the chair can swivel 360°. Once wheeled to the proper location, the chair can be anchored while the patient is seated by engaging the foot-operated wheel locks. The height of the chair can be increased from 41" to 48" by stepping on the foot pump arm. Hold the arm down and the chair slowly lowers to its minimum height. At the rear of the seat cushion is a locking handle which allows you to move the seat of the chair 4" to the left or right, while the base remains anchored. For lateral and posterior access, the back support and armrests drop out of the way with a simple tug of the corresponding pull pin. The wide armrest allows the Imaging Chair to double as an injection chair.

Specifications:

- Dimensions: 24" w x 41" h (64 x 104 cm)
Seat Dimensions: 17" w x 11" deep (43 x 28 cm)
Height Adjustable: 19" h to 26" h (48 to 66 cm)
Backrest: 19" above seat top (48 cm)
- Upholstery: 2" foam with gray vinyl cover
- Finish: Black baked enamel
- Wheels: Four locking swivel casters, 2" dia. (5 cm)
- Patient Capacity: 350 lb (159 kg)
- Weight: 75 lb (34 kg)
- Shipping Weight: 85 lb (38.5 kg)

214-610 Imaging Chair



Injection/Resting Chair

A comfortable rest between injection and imaging

Most protocols require that prior to imaging, a patient rest for up to one hour after an injection of FDG F-18. Typical injection chairs are not designed for comfort, making rest difficult.

The Injection/Resting Chair is a comfortable resting spot for patients to wait between injection and imaging. The chair achieves three recline positions and features an infinitely adjustable back. For patient safety, deep recline and Trendelenburg positions can only be achieved by the attendant. A quick release handle that spans the entire width of chair back allows effortless position change from either side of the chair.

Specifications:

- Dimensions: 35" w x 49" h (89 x 125 cm)
Seat: 20" depth x 25" w x 21" h (51 x 64 x 53 cm)
Back: 25" w x 34" h, above seat (64 x 86 cm)
- Upholstery: Blueridge, fire retardant
- Frame: Welded powder-coated steel
- Casters: Four 5" heavy-duty with positive locking swivel and wheel brakes
- Warranty: Five-year on frame
- Patient Capacity: 450 lb (204 kg)
- Weight: 116 lb (52.6 kg)

214-210 Chair, Injection/Resting



High Handle Foot Stool

This lightweight, yet durable stool is the safe and easy way for patients to get on or off examination tables. Steel construction assures long life. Rubber caps on the legs and a non-slip surface further assure stability and patient safety.

Specifications:

- Shipping Weight: 12 lb (5.5 kg)
- Patient Capacity: 250 lb (113.4 kg)



Niptongs

These low-cost tongs are used to handle small radioactive or otherwise dangerous objects up to 1" diameter. The tongs have a 45° v cut groove on each jaw. The compression spring maintains a strong grip on the object until the tension is released by squeezing the finger bar. Niptongs are made of chrome-plated, high carbon steel with hardwood handles and are easily disassembled for decontamination and cleaning.

214-728 Foot Stool, High Handle

011-012 Niptongs, 12" (30 cm)
011-036 Niptongs, 36" (91 cm)

Lab Equipment



Forceps

Surgical forceps are excellent handling devices for small items in the hot lab. No need to physically touch vials, ampules, etc. Forceps are made of surgical grade steel.



Forceps

These forceps are perfect for gripping vials rather than handling them with your hand. The serrated jaws and looped tip assure a solid grasp on the vial. The 9.5" length of these forceps reduces exposure. They are available straight or curved.

066-536 Forceps, Curved, non-locking, 12.5" | (31.7 cm)

0645-0025 Straight Forceps 9.5" (24.1 cm)

0645-0026 Curved Forceps 9.5" (24.1 cm)



CAP-TONGS

CAP-TONGS were designed for use in our own facility to pick up vials. We now offer this simple device to you for use in your lab. The CAP-TONGS are made of aluminum with rubber tips for a positive grip on the vial. Standard length is 9".

0645-0022 CAP-TONG Forceps 9" (22.8 cm)



Powder-Free Radiation Attenuating Gloves

Powder-Free Radiation Attenuating Gloves provide increased protection from direct X-ray beam and scattered radiation, and reduce harmful radiation exposure during any procedure requiring the use of fluoroscopy.

Just .007" thick, these gloves provide superior performance and dexterity over thicker, conventional radiation gloves. The reduced thickness allows for more flexibility and greater touch sensitivity while decreasing finger fatigue – all factors critical when working with delicate instruments. Applications include fluoroscopy, radioisotope handling, radiology and nuclear medicine.

Because these gloves are powder-free, lead-free and latex-free, they offer a reduced risk of natural rubber latex allergies and are an environmentally friendly alternative to leaded gloves.

Powder-Free Radiation Attenuating Gloves meet the following attenuation values:

58.7% attenuation at 60KVP HVL = 2.3 mm Al
 49.9% attenuation at 80KVP HVL = 3.3 mm Al
 44.6% attenuation at 100KVP HVL = 4.3 mm Al
 40.6% attenuation at 120KVP HVL = 5.6 mm Al

All gloves are shipped sterile and ready to use in single pair packages.

208-070	Gloves, size 7, pr 2
208-075	Gloves, size 7-1/2, pr
208-080	Gloves, size 8, pr
208-085	Gloves, size 8-1/2, pr
208-090	Gloves, size 9, pr

Lab Equipment



Absorbent Paper

Protect any work surface with plastic lined Absorbent Paper. Spills and splashes are immediately contained without messy clean up. Available in pre-cut sheets or by the roll, Absorbent Paper is efficient for any work surface.

Together with the optional paper dispenser, the 300-foot Absorbent Paper Roll can be conveniently located to any wall or bench. It works like a common paper towel dispenser, yet is extra-strong to support the oversized 11 lb roll.

Specifications:

033-304 Absorbent Paper Rolls

- Dimensions: 300' l x 20" w (91.5 m x 51 cm)
- Shipping Weight: 33 lb (15.8 kg)

033-013 Absorbent Paper Sheets

- Dimensions: 17" l x 13" w (43 x 33 cm)

033-304 Absorbent Paper, Rolls, 300 ft/roll, 2/pkg
033-013 Absorbent Paper, Sheets, 50/pkg

Related:
046-275 Dispenser, Disposable Protective Roll
For 033-304 Absorbent paper. Wall mounted.



Radi-Clean Decontaminant

This mild but powerful concentrate will safely remove radioactive contamination and problem substances from all types of lab apparatus. Radi-Clean cleaning power is comparable to a hot acid bath but with no hazard to personnel. At nominal dilution (1 to 50) with warm tap water, Radi-Clean Concentrate is negligibly corrosive, mildly alkaline, and harmless to skin and clothing. One liter makes 12 gallons of solution.

0601-0003 Radi-Clean Decontaminant (1 liter)

Lab Equipment



Decontamination Kit

This kit contains all protective clothing, decontaminants and accessories for handling radioactive spills or other routine contamination problems in the lab. Each kit comes in a 13 gallon plastic drum with a radioactive label and can be used for storing radioactive waste.

Contents of Kit

Quantity	Item
1	13 Gal EZ-Stor Poly Container with Hinged Lid, White
1	Vinyl Label "Caution Radioactive Material"
2	Disposable Zipper Coveralls with Hood
2 pair	Disposable PVC Booties, Yellow, 6 Mil
2	Half Mask Respirators, 5500 Series, with P100 Hepa Filters
2 pair	Latex Anti-C Gloves
1	Bottle Decon Hand and Instrument Cleaner with Sprayer
5	Yellow Polyethylene "Rad" Bags, 18" x 24", .004 Mil
1	Roll Yellow Tape with Magenta Lettering, "Radioactive Material", with Radiation Symbol
1 each	Sponge Mop, Pail, Dustpan and Brush
2	Yellow Warning Signs with Magenta Lettering, "Caution Contaminated Area" with Radiation Symbol
1	Roll 3 Strand "Rad" Rope, 5/16" x 50', Yellow/Yellow/Magenta
1	Pack of 50 Test Wipe Smears
1	Disposable Tong

0601-0019 Decontamination Kit, Complete



Minor Emergency Spill Kit

The Capintec Minor Spill Emergency Kit is based on the suggested contents described in NRC Reg Guide. The Minor Spill Kit is better suited for use in the Nuclear Medicine area.

All kits include translucent yellow tint, 4 mil plastic liners to be stored for quick retrieval in the event of a contamination incident. The kit includes Emergency Procedures and forms to document a spill and decontamination efforts.

Contents of Kit

Quantity	Item
6 pr	Disposable Gloves
1 pr	Housekeeping Gloves
2 ea	Disposable Lab Coats
2 ea	Disposable Head Covers
2 pr	Disposable Shoe Covers
5 ea	Plastic Backed Absorbent Paper
1 roll	Roll Absorbent Paper with Plastic Backing
6 ea	Yellow Plastic Bag Liners with Twist Ties
1 roll	"Caution Radioactive" Tape
1 ea	Black Pen
1 ea	Pencil
3 ea	"Caution Radioactive Material" Pre-Strung Tags
10 ea	Contamination Smears Samples
1 ea	Clipboard with "Emergency Procedures" Instructions and Forms

0601-0009 Minor Spill Emergency Kit

Lab Equipment



Tec-Control™ Chromatography Systems

Tec-Control Aluminum Breakthru Kit

The Aluminum Breakthru Kit provides a rapid, easy and inexpensive way to test aqueous solutions, particularly pertechnetate generator eluate, for trace quantities of aluminum. Aluminum forms an intense red precipitate with the indicator paper, and the intensity of the color is directly proportional to the amount of aluminum in the solution. The USP allows a concentration of aluminum ion in an injection ≤ 10 micrograms per milliliter (10 $\mu\text{g}/\text{ml}$) in technetium 99m eluate prepared from Molybdenum 99 formed as a result of uranium fission.

Simple Procedure:

1. Place a drop of the eluate or solution to be tested on the indicator paper. The best procedure is to form a hanging drop using a 19-22G needle.
2. Place a drop of the standard aluminum solution on the indicator paper. Use the same size drop.
3. Compare the intensity of the red spot formed. If the eluate spot is less intense than the standard solution, the eluate contains less than 10 $\mu\text{g}/\text{ml}$ aluminum.

References:

Miniaturized Chromatographic Quality-Control Procedures for Tc-99m Radiopharmaceuticals; A. Michael Zimmer and Dan G. Pavel, *Journal of Nuclear Medicine*, Vol. 18/12, Dec. 1977, pg. 1230.

Technical Parameters Associated with Miniaturized Chromatography Systems; Raimund A. Taukulis, A. Michael Zimmer, Dan G. Pavel and Bhupendra A. Patel, *University of Illinois Medical Center, Chicago, Illinois, Journal of Nuclear Medicine Technology*, Vol. 7/1.

- 150-780** Chromatography Kit, Tec-Control Aluminum Breakthru Kit includes: Aluminum standard, 5 ml, 10 $\mu\text{g}/\text{ml}$, 50 indicator strips and manual
- 150-785** Chromatography Kit, Tec-Control Aluminum Breakthru Kit includes: Aluminum standard, 5 ml, 5 $\mu\text{g}/\text{ml}$, 50 indicator strips and manual



Chromatography Strips and Solvents

Tec-Control Chromatography tests the radiochemical purity of specific Tc-99m-labeled radiopharmaceuticals. The accompanying chart shows which strips and solvents are required to perform each individual test. Some solvents must be purchased separately (see Sigma-Aldrich chart) due to hazardous material shipping restrictions. Detailed instruction manuals are packaged with each strip container, although our Radiopharmaceutical QC Procedure Manual (150-000) explains paper chromatography in greater detail.

Chromatography Strips

- 150-001** Strips, RED, 50/pkg
150-005 Strips, BLACK, 50/pkg
150-025 Strips, YELLOW, 50/pkg
150-122 Strips, ORANGE, 50/pkg
150-125 Strips, LIGHT BLUE, 50/pkg
150-126 Strips, BROWN, 50/pkg
150-127 Strips, GREEN, 50/pkg
150-130 Strips, GOLD, 50/pkg
150-771 Strips, DARK GREEN, 50/pkg
150-772 Strips, BLUE, 50/pkg
150-951 Strips, LIME, 50/pkg
150-952 Strips, PEACH, 50/pkg
150-971 Strips, TEAL, 50/pkg
150-991 Strips, PINK, 50/pkg
150-782 Strips, ALUMINUM, 50/pkg

Chromatography Solvents

- 150-160** Solvent, 20% Sodium Chloride, 30 ml
150-773 Solvent, DTPA, 5 ml
150-781 Solvent, Aluminum Standard, 5 ml, 10 $\mu\text{g}/\text{ml}$
150-783 Solvent, Aluminum Standard, 5 ml, 5 $\mu\text{g}/\text{ml}$

Related Items:

- 150-960** Developing Vials, Borosilicate Glass, 10 ml, 288/case (used for most Tec-Control testing)
150-961 Developing Vials, Borosilicate Glass, 5 ml, 144/case (used for Sestamibi & Tetrofosmin)
0645-0026 Forceps, Curved, locking, 9.5" l (24.1 cm)
0645-0025 Forceps, Straight, locking, 9.5" l (24.1 cm)
066-536 Forceps, Curved, non-locking, 12.5" l (31.7 cm)

Chromatography QC for the Following Radiopharmaceuticals:

Radiopharmaceutical	Solvent(s) Required*	Strips Required
Aluminum Breakthru	150-781	150-782
Aluminum Breakthru	150-783	150-782
Bicisate (Neurolite™)	Ethyl Acetate 99.%	150-130
Diphosphonate	Acetone (HPLC Grade), Distilled H2O	150-001 & 150-005
Disofenin (Hepatolite™)	150-160, Distilled H2O	150-122 & 150-125
DMSA	Acetone (HPLC Grade),	150-025
DTPA	Acetone (HPLC Grade), Distilled H2O	150-001 & 150-005
Exametazine (Ceretek™)	Ethyl Acetate 99.%	150-130
Fluorodeoxyglucose (FDG)	Acetone (HPLC Grade)	150-127
Glucoheptonate	Acetone (HPLC Grade), Distilled H2O	150-001 & 150-005
HDP; HMDP and Octreoscan™ HDP	Acetone (HPLC Grade), Distilled H2O	150-001 & 150-126
MAA	Acetone (HPLC Grade),	150-001
MAG3 (Mertiatide™)	Acetone, (HPLC Grade), Chloroform 99.8% Tetrahydrofuran 99+%	150-951 & 150-952
MDP	Acetone (HPLC Grade), Distilled H2O	150-001 & 150-005
Mebrofenin (Cholotec™)	150-160, Distilled H2O	150-122 & 150-125
Pyrophosphate	Acetone (HPLC Grade), Distilled H2O	150-001 & 150-005
Sestamibi (Cardiolite™ and Miraluma™)	Ethyl Acetate 99.%	150-991
Sulphur Colloid	Acetone (HPLC Grade),	150-001
Tc-99m (reduced)	Acetone (HPLC Grade),	150-001
Tc-99m Monoclonal Antibodies	0.9% Saline	150-771
Tetrofosmin (Myoview™)	Ethyl Acetate 99.%	150-971
In-111 Octreotide (Octreoscan™)	150-773 & 0.9% Saline	150-771 **
In-111 Monoclonal Antibodies	150-773 & 0.9% Saline	150-771 **
In-111/Y-90 Zevalin™	0.9% Saline	150-772
I-131 Monoclonal Antibodies and Neutrospec™	0.9% Saline	150-771

* See Sigma-Aldrich product matrix for solvents.

** Note: A Well Plate is suggested to perform QC on these radiopharmaceuticals.

Tec-Control Solvent Vendor: Sigma-Aldrich Chemical Company 800-558-9160 www.sigmaldrich.com	
<i>Note: Customers outside the US should visit the Sigma-Aldrich web site to locate a regional office.</i>	
Solvent Description	Vendor Part #
Acetone HPLC Grade	27072-5
Ethyl Acetate 99.5% ACS Reagent	31990-2
Chloroform 99.8% ACS Reagent	31998-8
Tetrahydrofuran 99+% ACS Reagent	36058-9

Radiopharmaceutical QC Manual

This detailed manual explains Paper Chromatography, a QC method for evaluating the radiochemical purity of currently used Tc-99m-labeled radiopharmaceuticals. Procedures are quick and easy to use, a simple quality control solution for any nuclear medicine department.

MINIATURIZED
CHROMATOGRAPHY
PROCEDURES FOR
RADIOPHARMACEUTICALS:
2011 UPDATE
150-000

BY
A. MICHAEL ZIMMER, PhD

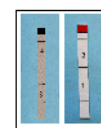
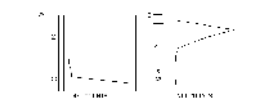

150-000 Procedure Manual, Radiopharmaceutical QC

Lab Equipment

HotPot™

Shielded dry heating block ideal for Tc-99m kit preparation

Features:

- Eliminates splashes from boiling water
- Digital temperature control
- Countdown timer with automatic shut off
- 4 mm lead shielding on all sides
- Heater range up to 160° C
- Durable powder coated steel housing
- Protective Teflon cover overheating element
- Four heating cavities to accommodate most common kit vials

Specifications:

- Temperature Setting Range: 5 °C - 160 °C (41 °F - 320 °F)
- Resolution: 1 °C (33.8 °F)
- Accuracy: +%5
- Operating Temperature: 5 °C - 40 °C (41 °F - 104 °F)
- Storage Temperature: 0 °C - 50 °C (0 °F - 122 °F)
- Power: 120 V/60 Hz or 220-240 V/50 Hz
- Weight: 14.3 lb (6.5 kg)

Physical

- 209 x 140 x 129 mm (8.2 x 5.5 x 5.1 in.)
- Shielding: 4 mm (.16 in.) lead

Kit and Vial Well Dimensions:

220V V version

- Hole 1: 21 mm diameter x 49.5 mm deep (.83 x 1.95 in.)
- Hole 2: 24 mm diameter x 41.5 mm deep (.94 x 1.63 in.)
- Hole 3: 22.5 mm diameter x 45.5 mm deep (.89 x 1.79 in.)
- Hole 4: 26 mm diameter x 45.5 mm deep (1.02 x 1.79 in.)

110V V version

- Hole 1: 25.5 mm diameter x 43 mm deep (1 x 1.7 in.)
- Hole 2: 22.6 mm diameter x 41 mm deep (.9 x 1.6 in.)
- Hole 3: 24.2 mm diameter x 27 mm deep (.95 x 1.1 in.)
- Hole 4: 24.2 mm diameter x 27 mm deep (.95 x 1.1 in.)

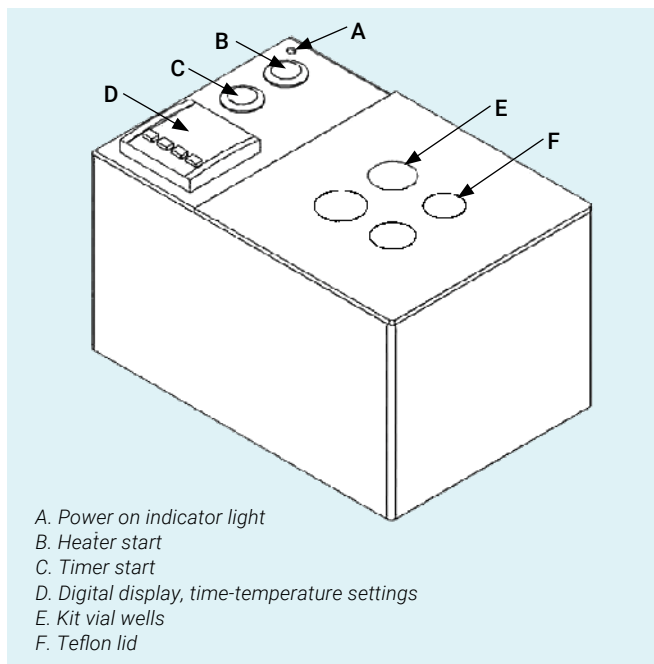

0651-0024 HotPot, 110 V
 0651-0023 HotPot, 220 V

Signs, Labels & Tags

Protect staff and visitors with convenient identification that conforms to government standards. Highly visible yellow labels and signage suggest caution where radioactive materials are present.

- Pressure Sensitive Shipping Labels
- Pre-Strung Tags
- Warning Tapes and Rope
- Radioactive Warning Labels
- Caution Signs



LAB SUPPLIES

Signs, Labels & Tags



Warning Rope

Made of high quality polypropylene, this triple strand rope assures high visibility and remarkable strength.

Features:

- Brightly colored - magenta and yellow
- Triple-strand strength

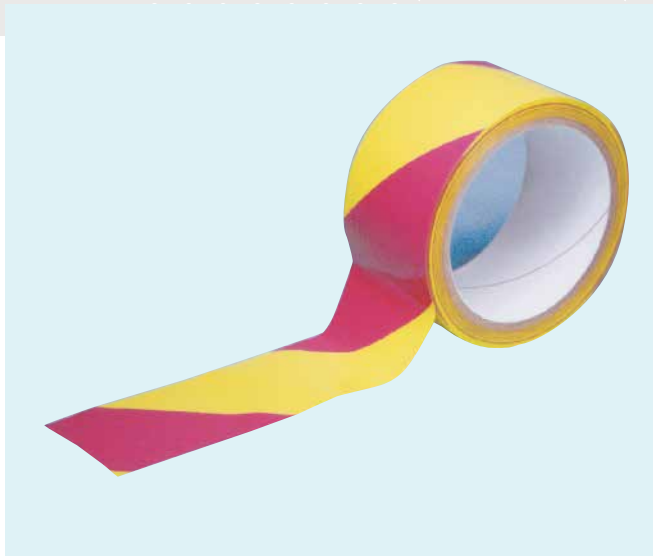

Hazard Tape

Hazard Tape is a highly visible magenta and yellow warning tape that's perfect for identifying physical hazard areas and materials. Its an inexpensive compliance with OSHA's code for nuclear hazard. Constructed of 6 mil. vinyl, the tape is durable to withstand long-term placement. The tape will easily affix to any clean, smooth, dry surface.

121-073 Rope, Warning, 100'/pkg
.31" dia (.8 cm)
Conveniently packaged in 100'
(31 meters) lengths

026-020 Tape, Hazard
2" w x 108' l (5 cm x 33 m)

Signs, Labels & Tags



024-914

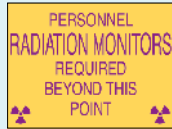

024-957



024-948

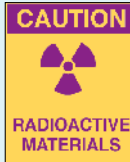

024-999

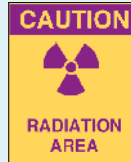

024-900



024-923



024-910

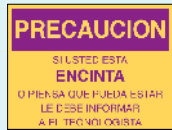

024-911

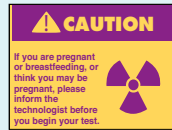

024-916

Plastic Caution Signs

These signs convey the warning clearly. They are constructed of heavy-duty polyethylene with convenient holes for indoor or outdoor mounting.

024-914	Sign, Caution, Radiation Area 14" w x 10" h (35.6 x 25.4 cm)
024-957	Sign, Radiation Monitors Required 14" w x 10" h (35.6 x 25.4 cm)
024-948	Sign, Caution, Radioactive Materials 14" w x 10" h (35.6 x 25.4 cm)
024-916	Sign, Caution, If you are Pregnant or Breastfeeding 14" w x 10" h (35.6 x 25.4 cm)
024-999	Sign, Caution, Radioactive Materials 7" w x 10" h (17.8 x 25.4 cm)
024-900	Sign, Caution, Radiation Area 7" w x 10" h (17.8 x 25.4 cm)
024-923	Sign, Caution, X-Ray Caution 7" w x 10" h (17.8 x 25.4 cm)
024-910	Sign, Caution, If you are Pregnant 14" w x 10" h (35.6 x 25.4 cm)
024-911	Sign, Precaucion, Si usted esta Encinta Spanish version of 024-910 14" w x 10" h (35.6 x 25.4 cm)

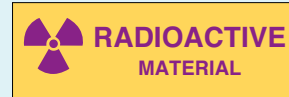

026-013

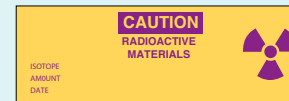

026-012



026-005

Perforated Warning Tapes

Pressure Sensitive adhesive plastic tapes stick to almost everything and are moisture resistant. All wording, symbols and colors conform to government regulations. Use ballpoint pen on tape labels for proper container identification. Continuous 180 ft. rolls.

026-013	Tape, Radioactive Material, 180 ft/roll 1" w x 3" l (2.5 x 8 cm)
026-012	Tape, Caution, Radioactive Materials, 180 ft/roll 1" w x 2" l (2.5 x 5 cm)
026-005	Tape, Caution, Radioactive Materials, 180 ft/roll .75" w x 1.38" l (1.90 x 3.5 cm) Suitable for test tubes, bottle necks, etc.

Signs, Labels & Tags



030-002

Pressure Sensitive Shipping Labels

Comply with Federal Regulations, Title 49 - Transportation of Hazardous Materials Regulations, Dept. of Transportation, 49CFR, Part 173 as to wording, symbols, size and colors.

Features:

- Pressure Sensitive
- Peel-off backing
- Package of 20

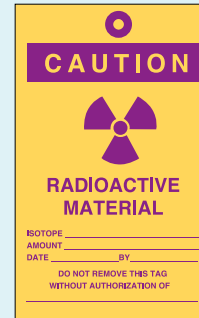

029-001

Pre-Strung Tag

Extra strength cardboard with reinforced string hole.

030-002 Label, Radioactive II, Yellow, 20/pkg

029-001 Tags, Container, 100/pkg
2.63" w x 5.25" h (7 x 13 cm)

Signs, Labels & Tags

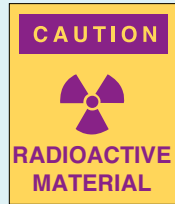

028-002

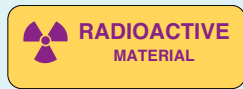

026-015



026-014

Pressure Sensitive Warning Labels

Pre-cut labels are mounted on a paper backing. Simply peel off the pre-cut label and apply.

- 028-002** Label, Caution, Radioactive Material, 20/pkg
5" w x 6" h (12.7 x 15.2 cm)
- 026-015** Label, Radioactive Material, 500/roll
3" w x 1" h (7.6 x 2.5 cm)
- 026-014** Label, Caution, Radioactive Material, 500/roll
2" w x 1" h (5 x 2.5 cm)

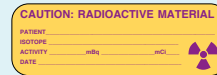

026-106

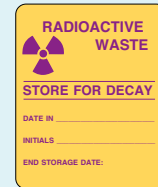

026-108



026-109 For documenting periodic checks of radioactive waste

Radioactive Warning Labels

Protects staff and visitors.

- 026-106** Label, Caution, Radioactive Material, 320/roll
3" w x .875" h (7.6 x 2.2 cm)
- 026-109** Label, Radioactive Waste, 240/roll
4" w x 2.63" h (10.2 x 6.7 cm)
- 026-108** Label, Radioactive Waste, 320/roll
2" w x 3" h (5 x 7.6 cm)



Nuclear Medicine

Empowering Better, Safer Diagnosis & Treatment

- Dose Calibrators
- Thyroid Uptake
- Lung Ventilation
- Shielding
- Lead-Lined Cabinets



LAB SUPPLIES

Hot Cells

All-In-One Hot Cell

Our All-In-One Hot Cell consists of a dual synthesizing cell and a dispensing cell to save space and cost, as well as comply with GMP guidelines. It is ideal for upgrading or renovating your current laboratory to achieve GMP requirements.

Features:

- The working chamber is SUS 316 stainless steel with rounded corners to minimize dust accumulation. The external surface is SUS 304 stainless steel.
- 75 mm of lead shields the front of the hot cell. All other sides have 60 mm or 75 mm of lead shielding.
- The Laminar Flow Dispensing Chamber includes HEPA filtration that provides air quality to comply with Grade A (Class 100/ISO 5).
- Unidirectional air flow in the Synthesis Chambers have HEPA filtration to comply with Class C or B (depending on the lab environment) requirements. Exhaust air passes through charcoal filtration.
- An innovative air vacuum technology system seals the inner containment door to ensure air tightness.
- The Smart Touch Control Panel integrates all operating functions and real-time monitoring information.
- The front of the Dispensing Cell has a lead glass viewing window and a tele-tong. The Synthesis Cells have a viewing CCTV monitor on the upper shielded hinged door.
- A shielded sliding door located on the side of the Dispensing Cell enables easy movement of material or products between the cells.
- The Dispensing Cell has a side door with a shielded glove port. An air ventilated lifter is equipped below the glove port to ensure the material and product deliver in or out the clean air chamber without cross-contamination.
- Radiation detectors measure the level of activity in each working chamber. When the radiation exceeds a preset safety level the interlock system prevents the door from opening (optional).
- It accommodates auto dispensers ADG-500 and ADG-500S.

Specifications:

- External Size: 106" h x 71" w x 44" d (270 x 180 x 113 cm)
- Internal Size: Dispensing Chamber: 27.5" h x 23.6" w x 31" d (70 x 60 x 79 cm)
Synthesis Chamber: 25.5" h x 27.5" w x 25" (65 x 70 x 64 x cm)
- Weight: 26014.5 lb (11800 kg)



- 5730-0004** All-In-One Hot Cell
(75/60/50 mm lead shielding)
- 5730-0005** All-In-One Hot Cell
(75/75/60 mm lead shielding)

Hot Cells

Dispensing Hot Cell

The Dispensing Hot Cell enables operators to handle the lower activity radiopharmaceuticals or isotopes through two shielded glove ports either by an automatic or semi-auto dispenser. It is ideal for PET center or nuclear medicine department to dispense the radiopharmaceuticals from bulk vial into syringes (unit dose) in a Grade A (Class 100/ISO 5) environment to comply with GMP.

Features:

- The working chamber is SUS 316 stainless steel with rounded corners to minimize dust accumulation. The external surfaces are SUS 304 stainless steel.
- The front face of the hot cell is shielded with either 75 or 60 mm of lead. All other sides have 75, 60, or 50 mm of lead shielding.
- The Laminar Flow Dispensing Chamber has HEPA filtration that provides air quality to comply with Grade A (Class 100/ISO 5).
- An innovative air vacuum technology system seals the inner containment door to ensure air tightness.
- The Smart Touch Control Panel integrates all operating functions, real-time monitoring information, and readings from the dose calibrator.
- The hinged front door has a lead glass viewing port and two shielded glove ports (the gloves are not shielded).
- Air ventilated elevator functioning in a Class 100 environment enable materials to be transferred into and out of the dispensing area without contamination.
- A 60 mm lead dose calibrator housing is equipped below the working level.
- A GM detector measures the radioactivity level in the working chamber. When the radiation exceeds a preset safety level the interlock prevents the doors from opening (optional).
- It accommodates auto dispenser ADG-2000.

Specifications:

- External Size:
94.4" h x 44.4" x 43.3" d (240 x 113 x 110 x cm)
(75/60 mm lead shielding)
94.4" h x 44.4" x 43.3" d (260 x 113 x 110 x cm)
(75/60 or 50 mm lead shielding)
- Internal Size: 27.5" h x 34.6" w x 27.5" d (70 x 88 x 70 x cm)
- Weight: 14330 lb (6500 kg)



5730-00012 Dispensing Hot Cell (75/60 mm lead shielding)

5730-00013 Dispensing Hot Cell (60/50 mm lead shielding)

5730-00014 Dispensing Hot Cell (75/75 mm lead shielding)

Dual Synthesis Hot Cell

The Dual Synthesis Hot Cell includes two segregated cabinets to accommodate two chemical modules (chemical synthesizer) in a vertical position. The shielded side cabinet is ideal to enlarge the space for placing the accessories of chemical modules or as a transfer box to delivery material or product in/out the hot cell.

Features:

- The working chambers are SUS 316 stainless steel with rounded corners to minimize dust accumulation. The external surfaces are SUS 304 stainless steel.
- 75 mm of lead shields the face of the hot cell. All other sides can be supplied with 60 mm or 75 mm lead shielding.
- A unidirectional air flow system in the synthesis chamber passes through a HEPA filter to ensure compliance with Classes C or B (depending on the lab environment). Exhaust air passes through a charcoal filter.
- An innovative air vacuum technology system seals the inner containment door to ensure air tightness.
- The Smart Touch Control Panel integrates all operating functions and real-time monitoring information.
- Hinged front doors allow complete access to the working chambers.
- A video monitor displays the output from a CCTV installed in each cell.
- A GM detector measures the radioactivity level in the working chamber. When the radiation exceeds a preset safety level the interlock prevents the doors from opening (optional).
- The optional side chamber with 20 mm of lead shielding is available as optional.

Specifications:

- External Size:
 - 102.3" h x 40" w x 42" d (260 x 102 x 107 cm)
(75/60 mm lead shielding)
 - 102.3 h x 59" w x 42" d (260 x 150 x 107 cm)
(75/60 mm lead shielding with 20 mm lead shielded side chamber)
- Internal Size:
 - 39.3" h x 28" w x 31.5" d (100 x 72 x 80 cm)
(75/60 mm lead shielding)
 - 26.7" h x 28" w x 25.5 d (68 x 72 x 65 cm)
(75/60 mm lead shielding with 20 mm lead shielded side chamber)
- Weight:
 - 18077.9 lb (8200 kg) (75/60 mm lead shielding)
 - 19841.6 lb (9000 kg) (75/60 mm lead shielding with 20 mm lead shielded side chamber)



- 5730-00018** Dual Synthesis Hot Cell (75/60 mm lead shielding)
- 5730-00019** Dual Synthesis Hot Cell (75/75 mm lead shielding)
- 5730-00029** Dual Synthesis Hot Cell (60/50 mm lead shielding)

Hot Cells

Manipulator Hot Cell

The Manipulator Hot Cell can be equipped with a pair of manipulators for handling and processing the high activity isotopes or radiopharmaceuticals under Grade A (Class 100/IOS 5) environment to comply with GMP regulations.

Features:

- The working chamber is SUS 316 stainless steel with rounded corners to minimize dust accumulation. The external surfaces are SUS 304 stainless steel.
- The front face of the hot cell is shielded with either 60 or 75 mm of lead. All other sides have 50, 60, or 75 mm of lead shielding.
- The Laminar Flow Dispensing Chamber includes HEPA filtration that provides air quality to comply with Grade A (Class 100/ISO 5).
- An innovative air vacuum technology system seals the inner containment door to ensure air tightness.
- The Smart Touch Control Panel integrates all operating functions, real-time monitoring information, and readings from the dose calibrator.
- The hinged front door has a lead glass viewing window.
- A pair of manipulator is equipped for handling and processing the isotope or radiopharmacy under Grade A condition (optional).
- Air ventilated elevator functioning in a Class 100 environment enable materials to be transferred into and out of the dispensing area without contamination.
- A 60 mm lead dose calibrator housing is equipped below the working level.
- A GM detector measures the radioactivity level in the working chamber. When the radiation exceeds a preset safety level the interlock prevents the doors from opening (optional).
- It accommodates dispensers ADG-500, ADG-500S, MVD-20, and APDS.

Specifications:

- External Size: 106" h x 55" w x 51" d (270 x 140 x 130 x cm)
- Internal Size: 39" h x 39" w x 31" d (100 x 100 x 80 x cm)
- Weight: 18078 lb (8200 kg)



5730-00015 Manipulator Hot Cell (60/50 mm lead shielding)

5730-00016 Manipulator Hot Cell (75/60 mm lead shielding)

5730-00017 Manipulator Hot Cell (75/75 mm lead shielding)



Production Hot Cell

The Production Hot Cell is equipped with two shielded glove ports, one tele-tong, and two lead glass viewing windows in the front. This hot cell allows for two operators to handle the isotopes simultaneously, and can support both research and GMP production facilities.

Features:

- The working chamber is SUS 316 stainless steel with rounded corners to minimize dust accumulation. The external surfaces are SUS 304 stainless steel.
- 75 or 60 mm of lead shields the front of the hot cell. All other sides have 75, 60 or 50 mm of lead shielding.
- The Laminar Flow Dispensing Chamber has HEPA filtration that provides air quality to comply with Grade A (Class 100/ISO 5).
- An innovative air vacuum technology system seals the inner containment door to ensure air tightness.
- The Smart Touch Control Panel integrates all operating functions, real-time monitoring information and readings from the dose calibrator.
- The hinged front door has a lead glass viewing window.
- Two shielded glove ports and one tele-tong enable manipulative work in the dispensing area.
- An air ventilated product elevator enables materials or products to be moved into and out of the dispensing area without contamination.
- A 60 mm lead dose calibrator housing is equipped below the working level.
- A radiation detector measures the radioactivity level in the working chamber. When the radiation exceeds a preset safety level the interlock prevents the doors from opening (optional).
- It is ideal for accommodating auto dispenser MVD-20.

Specifications:

- External Size: 102" h x 60" w x 47" d (260 x 152 x 120 cm)
- Internal Size: 25.5" h x 47" w x 29.5 d (65 x 120 x 75 x cm)
- Weight: 17196.06 lb (7800 kg)



- 5730-00009 Production Hot Cell (75/60 mm lead shielding)
- 5730-00010 Production Hot Cell (60/50 mm lead shielding)
- 5730-00011 Production Hot Cell (77/75 mm lead shielding)

Hot Cells

Synthesis Hot Cell

The Synthesis Hot Cell includes a large interior space to accommodate chemical module (chemical synthesizer) and accessories, such as HPLC detector. Two shielded boxes are equipped on front of the lower level for additional space or transfer box.

Features:

- The working chamber is SUS 316 stainless steel with rounded corners to minimize dust accumulation. The external surfaces are SUS 304 stainless steel.
- 75 mm of lead shields the face of the hot cell. All other sides can be supplied with 60 mm or 75 mm lead shielding.
- A unidirectional air flow system in the synthesis chamber passes through a HEPA filter to ensure compliance with classes C or B (depending on the lab environment). Exhaust air passes through a charcoal filter.
- An innovative air vacuum technology system seals the inner containment door to ensure air tightness.
- The Smart Touch Control Panel integrates all operating functions, real time monitoring information, and readings from the dose calibrator.
- Two overlapping hinged doors allow full access to the working chamber.
- A GM detector measures the radioactivity level in the working chamber. When the radiation exceeds a preset safety level the interlock prevents the doors from opening (optional).
- A video monitor displays the output from CCD cameras installed in the cell.

Specifications:

- External Size: 44" w x 41" d x 102" h (112 x 105 x 260 cm)
- Internal Size: 33" w x 27.5" d x 27.5" h (85 x 70 x 70 cm)
- Weight:
18078 lb (8200 kg) (75/60 mm lead shielding)
19841 lb (9000 kg) (75/75 mm lead shielding with 20 mm lead shielded side chamber)

for
PET



5730-00020 Synthesizing Hot Cell (75/60 mm lead shielding)
5730-00021 Synthesizing Hot Cell (75/75 mm lead shielding)

Tele-Tong Hot Cell

The Tele-Tong Hot Cell is equipped with two tele-tongs for handling and processing isotope and radiopharmaceuticals under Grade A (Class 100/ISO 5) environment to comply with GMP regulations.

Features:

- The working chamber is SUS 316 stainless steel with rounded corners to minimize dust accumulation. The external surfaces are SUS 304 stainless steel.
- 75 or 60 mm of lead shields the front of the hot cell. All other sides have 75, 60 or 50 mm of lead shielding.
- The Laminar Flow Dispensing Chamber has HEPA filtration that provides air quality to comply with Grade A (class 100/ISO 5).
- An innovative air vacuum technology system seals the inner containment door to ensure air tightness.
- The Smart Touch Control Panel integrates all operating functions, real-time monitoring information and readings from the dose calibrator.
- The hinged front door has a lead glass viewing window.
- Two tongs enable manipulative work in the dispensing area.
- A product elevator enables materials or products to be moved into and out of the dispensing area without contamination.
- A 60 mm lead dose calibrator housing is equipped below the working level.
- A radiation detector measures the radioactivity level in the working chamber. When the radiation exceeds a preset safety level the interlock prevents the doors from opening (optional).
- It accommodates auto dispensers ADG-500, ADG-500S, MVD-20, and APDS.

Specifications:

- External Size: 47" w x 51" d x 94" h (120 x 130 x 240 cm)
- Internal Size: 36" w x 34" d x 31" h (92 x 87 x 80 cm)
- Weight:
17196 lb (7800 kg) (75/60 mm lead shielding)
14991 lb (6800 kg) (75/60/50 mm lead shielding)



- 5730-00006** Tele-Tong Hot Cell (75/60 mm lead shielding)
- 5730-00007** Tele-Tong Hot Cell (75/60/50 mm lead shielding)
- 5730-00008** Tele-Tong Hot Cell (75/75 mm lead shielding)

LAB SUPPLIES

Shielded LAF & Fume Hoods

Portable Shielded Isolator

The Cleanroom Solution

The Germfree Portable Shielded Isolator provides the ultimate in both product and operator protection. The shielded isolator functions as a "glovebox" using negative pressure to meet NIOSH recommendations while complying with USP<797> and <825> regulations for use outside a cleanroom.

HEPA filtered unidirectional (laminar) air bathes the work area to protect the product from contamination and removes any particulate generated by sample manipulation. The operator is provided a complete shielded barrier from materials being manipulated in the work area. The Germfree Shielded Isolator meets or exceeds ISO 14644-1, ISO Class 5 (Class 100) air quality. Each shielded isolator undergoes rigorous physical testing to assure the unit meets performance requirements as validated. It is required that independent certification be performed before use.

What is a Barrier Laminar Flow Isolator?

According to the Food and Drug Administration, a barrier isolator is "a decontaminated unit supplied with HEPA filtered air that provides uncompromised continuous isolation of its interior from the external environment, including surrounding cleanroom air and personnel."

By installing a certified barrier isolator, one can obtain cleanroom conditions within a contained workspace. Barrier isolators provide an ISO Class 5 (Class 100) environment for product preparation, with work occurring inside a closed, pressurized environment accessible only via sealed gloves that reach into the work area.

A Shielded Glovebox is not a certified barrier isolator. By choosing a certified barrier isolator, the requirement for an ISO Class 8 environment is eliminated. The Germfree Isolator is an excellent example of a well-designed shielded barrier Laminar Flow Isolator, meeting all standards and more.

Antechamber

- Sealed two-door air lock maintains complete environmental separation between work area and ambient conditions.
- HEPA filtered purge of trapped air lock air eliminates cross-contamination between the work area and the room during both material ingress and egress.

Filtration

- Full framed, standard size mini-pleat HEPAs filter 100% of inlet and exhaust air from both the work area and the antechamber to provide a fully contained environment.
- HEPA filters are full coverage and front loading for easy replacement by a certifier.



Current Good Manufacturing Practice--Guidance for Human Drug Compounding Outsourcing Facilities Under Section 503B of the FD&C Act. (2020, January).
FDA.gov. <https://www.fda.gov/media/88905/download>

Shielded LAF & Fume Hoods

Ergonomics

- Hydraulic assist height adjusting stand offers a full 10" range, allowing operators to sit or stand comfortably for extended time periods.
- Stainless steel sliding tray inside the antechamber air lock that pulls forward for loading and unloading items into the air lock, eliminating reaching strains. The sliding tray lifts up 7.5" when the interior antechamber door is opened.
- Two part sleeve/glove system allows the use of most types and sizes of commercially available gloves for better dexterity and tactility.
- Extra large, oval glove ports are placed with bottoms together to provide an anthropometrically correct configuration that accommodates a wide range of body types and increases range of movement.
- Glove ports have a 3" armrest to reduce operator fatigue.
- Large viewing panel is at an angle to reduce glare and operator strain.

Sharps Container

- One sharps container in a locking shielded holder, located under the isolator in a .25" lead shield.
- Sharps tube is a straight 2.5" diameter tube to facilitate quick drop of the largest syringes with an easily removable shielded seal/stopper to maintain work area containment.

Safety

- Lockout handle requires key for access to work area and sharps container.
- Digital pressure readout with low pressure alarm for work area.
- Inward face velocity is 95-100 LFM at glove port opening, to protect operator/product during massive breach of containment.
- Glove changes can be made without breaking containment.
- Locking casters are standard; seismic anchors are available.

Cleaning

- Front viewing panel is top hinged and self supporting for easy access to the work area for cleaning and equipment ingress and egress.
- All filter diffuser/guard panels are removable for easy cleaning.
- Straight sides and back maximize work area to accommodate the many types and shapes of equipment and dose calibrators.
- All corners in work area, antechamber and work surface are easily reached and cleaned.

Configuration Options

- Overall work area pressure is negative with the option to externally exhaust.
- Optional Thimble Exhaust Transition Kit is available for connection to external exhaust systems.
- Fits Atomlab and other dose calibrators.

Features:

- Small footprint
- Designed from the ground up for a Radiopharmacy
- Work sitting or standing with correct ergonomics
- Meets USP Radiopharmaceuticals – Preparation, Compounding, Dispensing and Repackaging Guidelines
- Internal IV bar
- Sealed shielded dose calibrator chamber in the work surface
- Use for blood work or other compounding or drawing requirements
- Lead shielded (.25" thick) for compounding mid to low-energy sterile radiopharmaceuticals
- SO Class 5 (Class 100) Isolator

Specifications:

- Dimensions:
Overall Dimensions: 36" w x 32.5" depth x 79" h (91.4 x 82.5 x 200.7 cm)
Designed to fit through standard door openings and elevators.
Height Adjustment: 79" – 89" (200.7 x 226 cm)
Work Area Dimensions: 35" w x 25" depth x 28" h (88.9 x 63.5 x 71 cm)
- Viewing window:
Dimensions: 30" w x 23" h (76.2 x 58.4)
Lead Acrylic Shielding: 1.8" thick (46 mm)
Lead Equivalency: 2 mm for Tc-99m
- Construction: Stainless steel with a pharmaceutical grade finish
- Lead Shielding: .25" thick (.64 cm) on back, sides, bottom and front
- Fluorescent Lights: High efficiency; externally mounted to minimize heat build up. Separate lighted power ON/OFF switch.
- Motor/Blower: High capacity with speed control to extend HEPA filters life. Separate lighted power ON/OFF switch.
- Power: 115 VAC, 60 Hz (Optional 220 VAC, 50-60 Hz is available), 15 AMP line, running amperage = 6 AMP. Includes ten foot hospital grade power cord with molded grounded plug. Sealed outlet in work area.
- Weight: 1600 lb (725.7 kg)
- Warranty: Two years parts; one year labor*

*Offer applies to Continental United States only

190-215	Shielded Isolator, 115 VAC
190-214	Shielded Isolator, 220 VAC

Related:

5130-2216	CRC®-55tW Dose Calibrator.
190-220	Thimble Exhaust Transition Kit For connection to external exhaust systems

Replacement:

0660-0042	PET Sharps Inserts
------------------	--------------------

Shielded LAF & Fume Hoods

Bio-Safety Cabinet

Capintec provides custom shielding for a wide range of hoods and enclosures. Whether you require an inch of lead surrounding a work area or 2 in. of PET thick shielding and an integral body shield for quality assurance or dose preparation, we can provide a shielded hood for your applications.

Fully shielded Biological Safety Cabinet and Radioisotope Fume Hoods feature a mobile body shield with lead glass, to view the working area while protecting the worker. The mobile body shield can be moved to allow replacement of filters and for certification and servicing the hood. The mobile body shield moves smoothly into place or out of the way. Detailed drawings and specifications for typical designs are available to assist your efforts. Drawings for custom configurations are available on request.

Features:

- Standard shielding is 1' or 2" with custom shielding available
- Optional lead glass mobile body shield
- Flush mounting for dose calibrator ion chambers
- Environmental shielding for dose calibrator or other equipment
- 4' (122 cm) and 6' (183 cm) configurations available-
Note that dimensions vary with shielding selection
- NSF listed
- Optional UV lighting



5730-30342 4' Shielded A2 Bio-Safety Cabinet
5730-30346 4' Shielded B2 Bio-Safety Cabinet
5730-30350 6' Shielded A2 Bio-Safety Cabinet
5730-30354 6' Shielded B2 Bio-Safety Cabinet
Note: These all have a Sliding L-Block

Shielded LAF & Fume Hoods

Radiation Fume Hoods

The hoods are constructed of type 304 stainless steel and include an integral bottom with cup sink option. The one piece interior is free of joints, cracks, or crevices which prevents buildup of residue and simplifies decontamination procedures. These radiation fume hoods can be configured for a seated or standing working height. Because of the unique air flow and accessory requirements that are typical for radiation fume hood applications please contact us to discuss your special needs.

Features:

- Capintec hood offers both shielded and standard configurations
- 4' and 6' widths available
- 1" and 2" lead shielding available
- Custom configuration services available
- Optional integrated mobile lead glass work shields
- Three remotely controlled service fixtures
- Dedicated remote blower for superior exhaust characteristics



IMAGING QUALITY ASSURANCE

Phantoms



Jaszczak SPECT Phantom

The Jaszczak SPECT Phantom provides consistent performance information for any SPECT or PET system. Multiple performance characteristics of camera-based SPECT systems are evaluated from a single scan of the phantom.

On-axis and off-axis transverse line spread function may be easily measured without removing the cover plate. Measurements of full-width-half (or tenth) maximum can be readily determined, either in air or in water.

The Phantom is used for:

- System performance valuation of: Collimator, Artifacts, Calibration, and Reconstruction Parameters
- Acceptance testing
- Routine quality assurance and control
- Evaluation of:
 - Center-of-rotation error
 - Non-uniformity artifact
 - Changes of radius-of-rotation on spatial resolution
 - Reconstruction filters on spatial resolution
 - Attenuation and scatter compensation
- Single slice volume sensitivity
- Total system volume sensitivity
- Lesion detectability

SPECT Phantoms are available in two models. The Deluxe Phantom is used for high resolution cameras. The Standard Phantom is used for lower resolution cameras.

Specifications:

- Cylinder Interior Dimensions: 8.5" dia. x 7.32" h (21.6 x 18.6 cm)
- Cylinder Wall Thickness: 0.125" (3.2 mm)
- Volume: 6.9 L
- Volume With Inserts: 6.1 L
- Cold Rod Insert Height: 3.46" h (8.8 cm)
- Height of Spheres From Base Plate: 5" h (12.7 cm)

043-750 SPECT Phantom, Deluxe

- Cold Rod Dimensions: 4.8 mm, 6.4 mm, 7.9 mm, 9.5 mm, 11.1 mm, 12.7 mm
- Solid Sphere Diameters: 9.5mm, 12.7 mm, 15.9 mm, 19.1 mm, 25.4 mm, 31.8 mm
- Shipping Weight: 15 lb (6.9 kg)

043-762 SPECT Phantom, Standard

- Cold Rod Dimensions: 6.4 mm, 7.9 mm, 9.5 mm, 11.1 mm, 12.7 mm, 16.0 mm
- Solid Sphere Diameters: 12.7 mm, 15.9 mm, 19.1 mm, 25.4 mm, 31.8 mm, 38 mm

043-750 Phantom, SPECT, Deluxe
043-762 Phantom, SPECT, Standard

Related:
043-763 Phantom Insert, Hollow Spheres
043-730 Phantom Insert, Triple Line
043-777 Phantom Insert, Cardiac

Phantoms



Hoffman 3D Brain Phantom

The Hoffman 3D Brain Phantom provides the anatomically accurate three dimensional simulation of the radioisotope distribution found in the normal brain. The Phantom allows quantitative and qualitative study of the three dimensional effects of scatter attenuation as they would appear in Iodine-123-IMP or Iodine-123-HIPDM imaging with single photon emission computer tomography or fluorine-FDG-F18 imaging with positron emission computed tomography. The phantom simulates the 4:1 uptake ratio in the gray and white matter, normal in these studies. Ventricles that are normally void of radioactivity are present.

The phantom is comprised of sturdy plastic and a single fillable chamber that eliminates the necessity of preparing different concentrations of radioisotope. Nineteen independent plates stack neatly within the cylindrical phantom for easy disassembly and assembly. The user can easily add their own custom defects to simulate clinical abnormalities.

The Phantom can be filled with the appropriate radioactive material or contrast material for SPECT, PET or MRI applications.

Each of 19 inserts is made up of five thinner slices. Two slices 0.03" thick interspersed in 0.6" thick slices to create a composite slice.

Specifications:

- Cylinder Dimensions: I.D.: 6.9" h x 8.2" dia. (17.5 x 20.8 cm)
- Fillable Volume: ~ 1.2 L
- Shipping Weight: 23 lb (10.4 kg)

043-790 Phantom, Hoffman 3D Brain

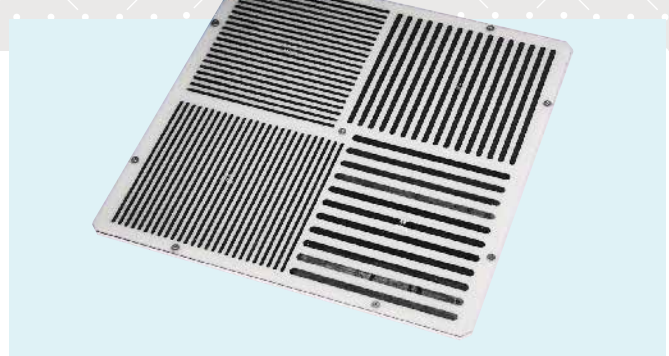

Bar Phantoms

Four-quadrant Bar Phantoms offer precise determination of camera intrinsic resolution, collimator spatial resolution, field size and linearity. We offer a range of sizes manufactured to the highest quality standards.

Specifications:

Rectangular Bar Phantom

- Dimensions: 22.25" l x 17" w x .5" h (56.5 x 43.2 x 1.27 cm)
- Lead Bar Widths: .079", .098", .118" and .138" (2, 2.5, 3 and 3.5 mm)
- Field Across Bar Configurations: 21" l x 15.9" w (53.3 x 40.5 cm)
- Shipping Weight: 21 lb (10 kg)

Standard High Resolution Bar Phantom

- Dimensions: 16.875" l x 16.875" w x .5" h (43 x 43 x 1.28 cm)
- Lead Bar Widths: .25", .187", .156", and .125" (6.4, 4.8, 4 and 3.2 mm)
- Field Across Bar Configurations: 15.875" l x 15.875" w (40.3 x 40.3 cm)
- Shipping Weight: 14 lb (6 kg)

Cardiac Bar Phantom

- Dimensions: 15.5" l x 9.25" w x .5" h (39.4 x 23.5 x 1.27 cm)
- Lead Bar Widths: .079", .098", .118" and .138" (2, 2.5, 3 and 3.5 mm)
- Field Across Bar Configurations: 14.5" l x 8.25" w (36.8 x 21 cm)
- Shipping Weight: 15 lb (6.80 kg)

Symbia and E-Cam Bar Phantom

Includes two removable screw knobs for insertion/removal of phantom from camera head.

- Dimensions: 16" l x 21" w x .5" h (40.6 x 53 x 1.27 cm)
- Lead Bar Widths: .079", .098", .118" and .138" (2, 2.5, 3 and 3.5 mm)
- Field Across Bar Configurations: 20.3" l x 14.875" w (51.6 x 37.8 cm)
- Shipping Weight: 19 lb (8.7 kg)

243-935	Bar Phantom, Rectangular
243-800	Bar Phantom, Standard, High Resolution
243-955	Bar Phantom, Cardiac, High Resolution
243-987	Bar Phantom, Symbia and E-Cam

Phantoms

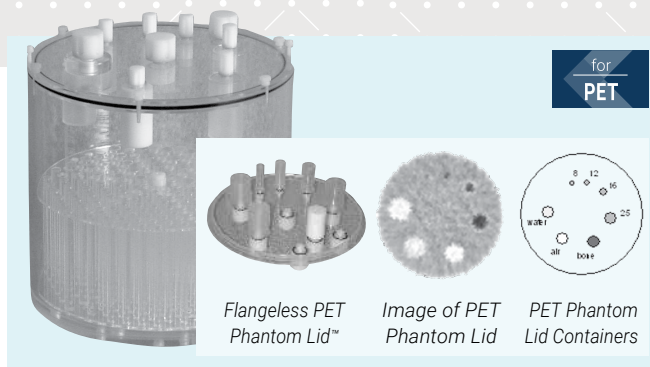
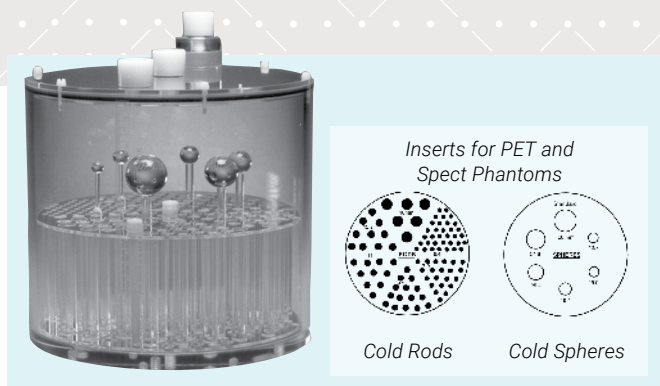

Jaszczak Flangeless Deluxe SPECT Phantom

The flangeless PET and SPECT phantoms provide consistent performance information for any PET or high-resolution SPECT system. Multiple performance characteristics of camera-based SPECT systems are evaluated from a single scan of the phantom.

On- and off-axis transverse line spread function may be easily measured without removing the cover plate. Measurements of full-width-half (or tenth) maximum can be readily determined, either in air or in water.

The flangeless phantoms for PET and SPECT meet the requirements set by the ACR.

The Phantoms are used for:

- System performance evaluation of: Collimator, Artifacts, Calibration, and Reconstruction Parameters
- Acceptance testing
- Routine quality assurance and control
- Evaluation of:
 - Center-of-rotation error
 - Non-uniformity artifact
 - Changes of radius-of-rotation on spatial resolution
 - Reconstruction filters on spatial resolution
 - Attenuation and scatter compensation
- Single slice volume sensitivity
- Total system volume sensitivity
- Lesion detectability

Esser Flangeless Deluxe PET Phantom

Specifications:

SPECT and PET Phantoms:

- Cylinder Interior Dimensions: 8" dia. x 7.32" h (20.4 x 18.6 cm)
- Volume: 6.4 L
- Cold Rod Insert Height: 3.46" h (8.8 cm)
- Cold Rod Diameters: 4.8, 6.4, 7.9, 9.5, 11.1 and 12.7 mm
- Height of Spheres From Base Plate: 5" h (12.7 cm)
- Solid Sphere Diameters: 9.5, 12.7, 15.9, 19.1, 25.4 and 31.8 mm

Flangeless Esser PET Phantom Lid:

- Refillable thin-walled cylinders: 8, 12, 16, 25 (x3) mm
- Solid cylinder (Teflon): 25 mm
- Cylinder height: 1.5 in
- Lid Closure: Bayonet-Style with Lock Screw

043-765 Phantom, SPECT, Flangeless, Deluxe
043-772 Phantom, PET, Flangeless, Esser
043-757 Phantom, PET/SPECT, Flangeless
Includes PET and SPECT phantom lids

Related:
043-763 Phantom, Hollow Spheres Set (6)
043-730 Phantom Insert, Triple Line
043-777 Phantom Insert, Cardiac

Phantoms

for
PET**PET-CT Phantom™**

The PET-CT Phantom includes internal structures (three rods and six spheres) which, when imaged with both modalities, can demonstrate how accurately the two image sets are aligned. In addition, a single sample of radioactive water is attenuated by water, bone and CT contrast material (as well as air only) to determine how accurately the CT-based PET attenuation correction works.

Used for acceptance testing and routine quality evaluation of PET/CT and SPECT/CT systems, evaluating image fusion software, assessing new attenuation correction algorithms, and research. Aluminum tubes are for registration. The outer 2" OD micro cylinder compares attenuation region to non attenuation region. The 6" ring is for contrast solution.

Specifications:

- Main Cylinder:
 - Interior length of phantom: 180 mm
 - Fillable spheres (5) inner diameter: 10 mm, 13 mm, 17 mm, 22 mm, and 28 mm.
- Distance from sphere plane to inside wall: 70 mm
- Volume of empty cylinder: 9.7 liters
- Main Cylindrical insert dimension:
 - Outside diameter: 51 mm
 - Length: 180 mm
- Top Cylinder:
 - Cylinder outside diameter: ~5.1 cm
 - Cylinder inside diameter: ~4. cm
 - Cylinder inside height: ~8.2 cm
 - Cylinder outside height: ~12.0 cm
 - Volume of empty cylinder: 408 cm²
- Three Aluminum Tubes:
 - One 5 inch long: ~1.7 cc
 - Two 7 inch (ea): ~ 2.5 cc
- Stepped Bone Ring:
 - Pre-filled with liquid bone composition, not to be opened
 - The volumes for the bone ring are:
 - Outer volume: 15.6 cu inch: ~256 cc
 - Inner volume: 6.7 cu inch: ~110 cc

043-771 Phantom, PET-CT

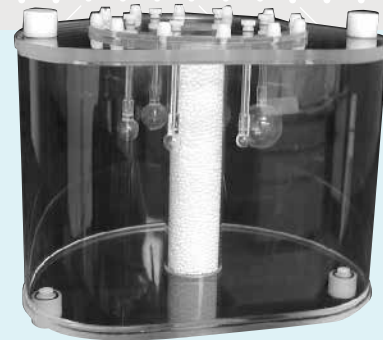
for
PET**NEMA 2012 PET Phantom****Features:**

- Complies with NEMA 2012 Standard
- Simulation of whole-body imaging using PET and camera-based coincidence imaging techniques
- Evaluation of reconstructed image quality in whole-body PET and camera-based coincidence imaging
- Determination of the coincidence count rate characteristics in brain and cardiac imaging
- Evaluation of the relationship between true coincidence count rate and radioactivity
- Determination of the address errors caused by address pile up
- Evaluation of the count loss correction scheme

Specifications:

- Dimensions: 9.5" h x 12" w x 9.5 depth (24.1 x 30.5 x 24.1 cm)
- Interior Length of Phantom: 180 mm
- Fillable Spheres (six) Inner Diameter: 10 mm, 13 mm, 17 mm, 22 mm, 28 mm and 37 mm
- Distance From Sphere Plane to Inside Wall: 70 mm
- Volume of Empty D Shaped Cylinder: 9.7 L
- Cylindrical Insert Dimension: O.D.: 51 mm dia. x 180 mm length
- Shipping Weight: 11 lb (4.9 kg)

Performance Measurements of Positron Emission Tomographs, NEMA Standards Publication No. NU2, National Electrical Manufacturers Association (NEMA), Washington, DC, 2012 NEMA 2012ForPETForPET

043-767 Phantom, PET, NEMA 2012

Phantoms



Spect Anthropomorphic Torso Phantom

Used for the evaluation of non-uniform attenuation and scatter compensation methods, the phantom consists of a large, body-shaped cylinder with lung, liver and spine inserts. The phantom simulates the anatomical structures of radioactivity distributions for the upper torso of average to large male/female patients. Lung inserts can be filled with Styrofoam beads and water to simulate lung tissue density. When used with the optional Cardiac Insert, cardiac ECT data acquisition and reconstruction methods may also be evaluated.

Specifications:

- Dimensions:
O.D.: 10.25" anterior-posterior x 15" lateral (26 x 38 cm)
I.D.: 9.5" anterior-posterior x 14.2" lateral (24 x 36 cm)
- Wall Thickness: 0.37" (9.5 mm)
- Volumes:
Left Lung (w/o Styrofoam beads): ~ 0.9 L
Right Lung (w/o Styrofoam beads): ~ 1.1 L
Left Lung (w/ Styrofoam beads): ~ 0.36 L
Right Lung (w/ Styrofoam beads): ~ 0.44 L
Liver: ~ 1.2 L
Background: ~ 10.3 L
Cylinder w/ Lung-Spine Insert: ~ 7.4 L

043-795 Phantom, Anthropomorphic Torso

Related:
043-777 Cardiac Insert

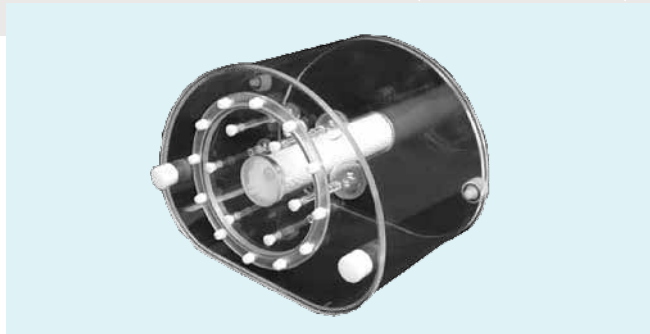

NEMA IEC PET Body Phantom Set™

A body phantom, a lung insert and an insert with six spheres with various sizes

Features:

- The NEMA IEC Body Phantom Set consists of a body phantom, a lung insert and an insert with six spheres with various sizes
- It is designed in accordance with the recommendations by the International Electrotechnical Commission (IEC) and modified by the National Electrical manufacturers Association (NEMA)
- It is recommended for use in the evaluation of reconstructed image quality in whole body PET imaging

Applications

- Simulation of whole-body imaging especially using PET and camera-based coincidence imaging techniques
- Evaluation of reconstructed image quality in whole body PET and camera-based coincidence imaging
- Determination of the coincidence count rate characteristics in brain and cardiac imaging
- Evaluation of the relationship between true coincidence count rate and radioactivity
- Determination of the address errors caused by address pile up
- Evaluation of the count loss correction scheme
- Research

Specifications:

- Interior length of phantom: 180 mm
- Fillable spheres (6) inner diameter: 10 mm, 13 mm, 17 mm, 22 mm, 28 mm, and 37 mm.
- Distance from sphere plane to inside wall: 70 mm
- Volume of empty cylinder: 9.7 liters
- Cylindrical insert dimension:
Outside diameter: 51 mm x length: 180 mm

5250-0161 NEMA IEC Body Phantom Set

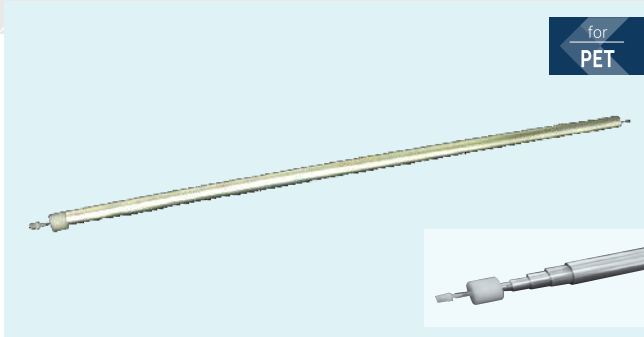

NEMA PET Sensitivity Phantom™

Six Concentric aluminum tubes used to detect camera sensitivity in PET.

Specifications:

Five internally stacked concentric aluminum tubes all 700 mm in length

- 1st Tube
Inside Diameter: 3.9 mm
Outside Diameter: 6.4 mm
- 2nd Tube
Inside Diameter: 7.0 mm
Outside Diameter: 9.5 mm
- 3rd Tube
Inside Diameter: 10.2 mm
Outside Diameter: 12.7 mm
- 4th Tube
Inside Diameter: 13.4 mm
Outside Diameter: 15.9 mm
- 5th Tube
Inside Diameter: 16.6 mm
Outside Diameter: 19.1 mm
- Innermost Tube (a fillable polyethylene tube)
Inside Diameter: 1 mm
Outside Diameter: 3 mm

Performance Measurements of Scintillation Cameras, NEMA Standards Publication No. NU2, National Electrical Manufacturers Association (NEMA), Washington, D.C., 2001

5250-0165 NEMA PET Sensitivity Phantom



Hollow Sphere Inserts

Features:

- Designed for use in all circular and elliptical SPECT cylinders
- Simulates hot and cold spherical "lesions"
- Quantitative evaluation of spatial resolution/object size, attenuation and scatter effects
- Evaluation of quantitative ECT reconstruction methods

Specifications:

- Set: Six hollow spheres (each individually removable and fillable)
- Diameter: I.D.: 9.9 mm, 12.4 mm, 15.6 mm, 19.7 mm, 24.8 mm, and 31.2 mm
- Volume of Spheres: 0.5 ml, 1.0 ml, 2.0 ml, 4.0 ml, 8.0 ml, and 16.0 ml

043-763 Phantom Insert, Hollow Spheres

Related:

043-765 Phantom, SPECT, Flangeless

043-750 Phantom, SPECT, Deluxe

043-762 Phantom, SPECT, Standard

Phantoms

PHANTOMS



Triple Line Insert

Used to produce three 1 mm diameter parallel lines of tracer material spaced 7.5 cm apart. The locations of the fillable tubes are based on the recommendations in the NEMA Standards Publication for Performance Measurements of Scintillation Cameras, 1986.

Radioactive tracer liquid can be inserted into the line sources through surgical grade, stainless steel valves located at the ends of each line tube. The cylinder can be filled with water to simulate the surrounding attenuating medium. Quantitative measurements of on-axis and off-axis reconstructed line source resolutions can be performed in air by placing the triple line insert directly on the scanning bed. The triple line insert provides accurate, reproducible images to quantitatively evaluate the effects of errors in center-of-rotation and radius-of-rotation on scanners. Using the insert, the influence of the type of reconstruction filter on SPECT spatial resolution measurements can be evaluated.

Specifications:

- Useful Height of Line Sources: 2.76" (7 cm)
- Diameter of Insert: 7.3" (18.6 cm)
- Diameter of Line Sources: ~1 mm
- Spacing of Line Sources: 2.95" (7.5 cm)
- Shipping Weight: 3 lb (1.3 kg)

043-730 Phantom Insert, Triple Line

Related:

- 043-765** Phantom, SPECT, Flangeless
- 043-772** Phantom, PET, SPECT, ACR
- 043-750** Phantom, SPECT, Deluxe
- 043-762** Phantom, SPECT, Standard



Cardiac Insert

This insert provides a multi-function simulation of the left ventricle, and can be used to evaluate SPECT imaging of cold defects within the "myocardium." Two solid acrylic sectors (45 and 60 degrees) are supplied with the insert, each 1 cm thick and 2 cm long. These non-filling defects may be placed at various positions within the "ventricle wall", either anteriorly or posteriorly. The long axis of the "ventricle" is adjustable from 30 to 60 degrees from the long axis of the cylinder. Four fillable defects are also included.

Used to evaluate cardiac ECT data and attenuation/scatter. Simulates normal and abnormal myocardial uptake. Solid inserts simulate transmural and non-transmural cold abnormalities. Fillable inserts simulate transmural and non-transmural cold or hot abnormalities.

Specifications:

- "Ventricle" Overall Dimensions: 3.7" l x 2.4" dia. (9.3 x 6.1 cm)
- "Ventricle" Volume: ~ 60 ml
- "Myocardium" Thickness: 0.4" (1.0 cm)
- "Myocardium" Volume: ~ 110 ml
- Solid Defect Set (three pieces):
 1. 60° x 2 cm (h) x 10 mm (thick)
 2. 45° x 1.53 cm (h) x 10 mm (thick)
 3. 60° x 2 cm, with 5 mm wall thickness (non-transmural defect)
- Fillable Defect Set (four pieces):
 1. 180° x 2 cm (h) x 10 mm (thick) / Vol ~ 13 ml
 2. 90° x 2 cm (h) x 10 mm (thick) / Vol ~ 5.4 ml
 3. 45° x 2 cm (h) x 10 mm (thick) / Vol ~ 3.8 ml
 4. 45° x 2 cm (h), with 5 mm thick chamber / Vol ~ 1.4 ml

043-777 Phantom Insert, Cardiac
Includes: Defect Set

Related:

- 043-765** Phantom, SPECT, Flangeless
- 043-772** Phantom, PET, SPECT, ACR
- 043-750** Phantom, SPECT, Deluxe
- 043-762** Phantom, SPECT, Standard
- 043-795** Phantom, Anthropomorphic Torso

Anthropomorphic Phantoms

Radiation equivalent and anatomically correct realistic test subjects

The Heart/Thorax Phantom is ideal for evaluation of detectability, extent and severity of myocardial infarcts in patients. This Phantom also provides valid assessment of mammoscintigraphy techniques. The Striatal Phantom optimizes quantitative imaging in patients, using PET or SPECT.

Myocardial perfusion SPECT is a widely-used, non-invasive method for the diagnosis and management of patients with coronary disease. However, non-uniform photon attenuation, Compton scatter, limited and depth-dependent spatial resolution, as well as image noise, limit the ability of SPECT to obtain images that reliably represent the true tracer distribution. The non-uniform attenuation of the thorax is the most significant factor limiting the diagnostic efficacy of myocardial SPECT.

The currently used attenuation, scatter and resolution correction methods are suboptimal, since they do not provide improvement in the 25% false-negative findings in a group of about 100 patients with luminal diameter stenoses of at least 50%. Furthermore, the ability to detect multivessel disease was 70% without and 47% with corrections. This finding implies that myocardial SPECT can seriously underestimate the extent of disease in high-risk patients. On the other hand, the false-positive findings in the group with a low probability of coronary disease were reduced from 14% without w to 3% with corrections.

Obviously, further improvements in both hardware and software for myocardial SPECT are necessary before this important diagnostic technique can realize its full potential. These improvements must be carefully evaluated on realistic, anthropomorphic phantoms to improve results in clinical practice.

The Head

The Head Phantom is based upon a standard head with a calvarial cut to insert or remove the brain shell easily. The nasal cavity and maxillary sinuses are filled with foam with a mass density of 0.23 g/cc.

Brain Shell

The brain shell has five compartments which can be filled separately: left and right nucleus caudate, left and right putamen, and the remainder of the brain. This allows different nucleus caudate to putamen ratios as well as different striatal to background ratios to be obtained; this also permits differences between left and right striatal activity to be examined.



Features:

- Receptor Quantification As A Function Of Uptake Ratio
- Partial Volume Effects
- Scatter And Attenuation-Correction Schemes
- Threshold for Changes in Uptake
- Comparison Of Different Acquisition Modes, e.g. 2-D Vs 3D Pet
- Design Of Different Reconstruction Strategies
- Testing And Validation Of Image Registration Techniques
- Design Of Imaging Protocol For Patients

5220-RS800T	Heart/Thorax Phantom
5220-RS900T	Striatal Phantom Head with Transparent Brain & Striatum
5220-RS901T	Transparent Brain Shell with Striatum

CT QA



MRI QA

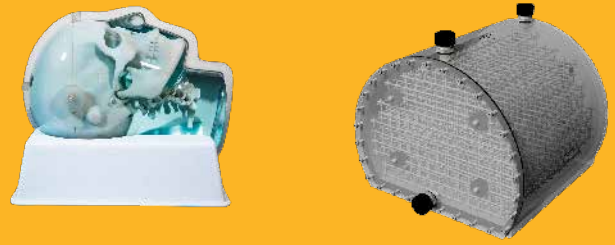

Ultrasound QA



Comprehensive Diagnostic Imaging Phantoms from Mirion Medical

Better Quality Management. Better Care.

- CT Phantoms
- MRI Phantoms
- Ultrasound Phantoms
- Mammography Phantoms

For additional information visit, sunuclear.com/diagnostic



SUN NUCLEAR
A MIRION MEDICAL COMPANY

Advanced CT QA

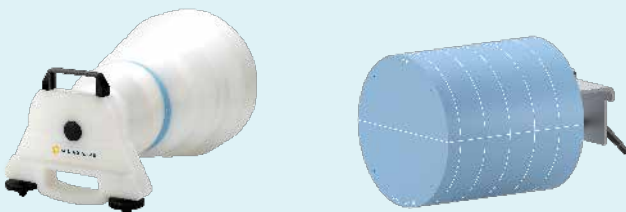

Mammography QA

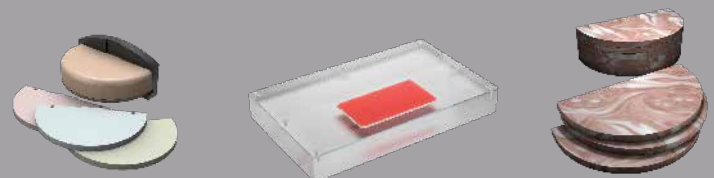

001-075	67	007-691	61	026-015	123	053-806	65	0670-0022	26	132-685	42	177-325	36	5120-2258	11	5530-1029	84
001-179	69	007-693	61	026-020	120	053-807	66	0670-0025	57	132-690	40	185-302	46	5120-2286	17	5530-1030	84, 88
001-180	69	007-695	61	026-106	123	0550-0003	85	0670-0026	57	132-691	40	190-214	133	5126-2001	11, 16	5530-1031	83
001-181	69	007-711	62	026-108	123	060-133	48	0670-0029	56	132-692	41	190-215	133	5130-0006	5, 13, 14	5530-20178	73
001-182	69	007-712	62	026-109	123	060-137	48	0670-20002	56	132-695	43	190-220	133			5530-20179	73
001-236	66	007-713	62	028-002	123	0601-0003	114	0680-0013	92	132-698	43	2001-0055	21	5120-20302	20	5530-2074	88
001-280	81	007-716	62	029-001	122	0601-0009	115	0680-0016	92	132-699	41	208-070	113	5130-20252	20	5530-2077	84
001-280	79, 80	007-717	62	030-002	122	0601-0019	115	0680-0017	92	132-750	45	208-075	113	5130-20253	13	5550-0002	86
001-281	79, 80, 81	007-718	62	033-013	114	0625-0003	55	0680-0018	92	132-770	41	208-080	113	5130-20254	13	5730-00004	125
		007-723	59	033-304	74	0625-0011	53	0960-0183	20	132-771	41	208-085	113	5130-2046	5, 13, 14	5730-00005	125
001-282	79, 80, 81	007-734	59	039-106	73	0625-0012	53	0975-0002	104	132-772	47	208-090	113			5730-00006	131
		007-735	59	039-110	72	0625-0013	53	0975-0003	104	132-773	47	214-210	110	5130-2086	86	5730-00007	131
001-283	79, 81	007-736	59	039-326	71	0625-0014	53	0975-0006	104	132-774	41	214-220	109	5130-2090	85, 87	5730-00008	131
001-284	75, 80, 81	007-738	59	042-435	88	0625-0015	53	0975-0008	104	132-781	40	214-610	110	5130-2161	87	5730-00009	129
		007-755	59	040-108	73	0625-0016	53	0975-0025	107	132-784	30	214-728	111	5130-2216	9, 102, 133	5730-00010	129
001-706	66, 77	007-800	59	040-315	69	0625-0017	53	0975-0137	30	132-793	40	243-800	137			5730-00011	129
001-707	66, 77	007-801	59	042-407	91	0625-0018	53	0975-137R	29,	134-772	42	243-935	137	5130-2238	7	5730-00012	126
001-708	76	007-803	59	042-433	82, 94	0625-0019	53		107	135-022	109	243-955	137	5130-30251	11, 20	5730-00013	126
001-711	66, 77	007-901	59	042-434	82, 88, 94, 102	063-140	107	0975-139X	108	136-755	37, 38	243-987	137	5130-30261	11	5730-00014	126
001-721	75, 76, 77, 78	007-945	62			063-261	104	0975-152R	29,	139-101	47	244-004	100	5130-3234	5	5730-00015	128
		007-956	60	042-435	82	063-362	105		107	139-102	46	244-005	100	5130-3235	7, 94	5730-00016	128
001-723	76	007-957	60	042-448	102	063-562	104	0975-3720	104	139-104	47	244-006	101	5220-RS800T	143	5730-00017	128
001-724	77	007-958	60	042-456	101	063-586	104	0975-3725	104	139-677	44	244-007	97	5220-RS900T	143	5730-00018	127
001-726	75, 76, 77	007-961	64	042-519	89	063-700	106	0975-5710	104	139-680	45	244-008	97	5220-RS901T	143	5730-00019	127
		007-962	64	042-522	89	063-701	106	099-289	106	150-000	117	244-009	100	5230-0010	51	5730-00020	130
001-730	75, 76, 77	007-966	64	042-585	90	063-720	104	1000-0207	86	150-001	116	244-110	95	5230-0038	23, 25	5730-00021	130
		007-967	64	043-274	106	0645-0021	73	1000-0208	86	150-005	116	244-111	95	5250-0022	11	5730-00029	127
001-739	75	007-968	63, 64	043-730	136, 138, 142	0645-0022	113	1000-0211	85	150-025	116	244-112	95	5250-00256	52	5730-00031	87
001-754	79, 80	007-969	63		142	0645-0025	112,	101-103	38, 108	150-122	116	244-120	99	5250-0161	140	5730-0032	87
001-756	80	007-973	63	043-750	136, 141,		116	101-356	104	150-125	116	244-121	99	5250-0165	141	5730-0033	87
001-757	80	007-974	62, 63,		142	0645-0026	112,	103-701	92	150-126	116	244-122	99	5250-0212	30	5730-2271	71, 94
001-771	66, 75, 80	007-974	64	043-757	138		116	117-425	91	150-127	116	244-130	102	5250-0213	30	5730-30342	134
		007-975	63	043-762	136, 141,	0651-0023	118	117-808	67	150-130	116	244-131	102	5250-0214	30	5730-30346	134
001-771	75, 77, 78	007-980	63		142	0651-0024	118	121-073	120	150-160	116	244-132	102	5250-0215	30	5730-30346	134
		007-983	63	043-763	136, 138,	0652-0037	54	123-500	105	150-315	37, 38	244-140	95	5250-1000	51	5730-30350	134
001-779	80	007-985	63		141	0652-0038	54	127-691	61	150-317	38	244-141	95	5250-1001	51	5730-30354	134
001-785	75, 81	007-985	63	043-765	138, 141,	0652-0041	54	127-693	61	150-771	116	244-142	95	5250-2110	30	70670-0016	29
001-786	75	007-990	63		142	0652-0043	55	127-695	61	150-772	116	244-150	97	5300-0025	135	7120-1199	5, 7, 9, 19
001-787	75	007-995	63	043-767	139	0652-0046	55	127-734	59	150-773	116	244-151	97	5420-0086	25		
001-788	80, 81	007-999	68	043-771	139	0652-0047	55	127-735	59	150-780	116	244-152	97	5420-0087	33	7120-1240	19
001-789	80, 81	008-300	72	043-772	138, 142	0652-0057	55	127-738	59	150-781	116	244-160	97	5420-0121	29, 32	7300-2004	5, 7, 9, 13, 17
001-793	78	008-400	79, 81	043-777	136, 138,	0652-0058	55	130-019	47	150-782	116	244-161	97	5420-0121	29, 32	7300-2004	5, 7, 9, 13, 17
001-794	78	009-205	68		140, 142	0652-0061	53	130-020	47	150-783	116	244-162	97	5420-2072	9, 18, 29, 31	7300-2005	5, 7, 9, 13, 15
001-798	75	011-012	111	043-790	137	066-533	67, 79	130-020	47	150-783	116	244-162	97	5420-2137	32		
006-350	25	011-036	111	043-795	140, 142	066-535	67	130-100	44	150-785	116	244-170	98	5420-2137	32	7300-2450	5, 7, 9, 13, 16
006-352	25	024-900	121					130-639	46	150-951	116	244-171	98	5420-2141	18, 29, 31		
007-007	69	024-910	121	043-840	103	066-536	67, 112,	130-900	37, 48	150-952	116	244-172	98	5420-2164	23	7300-2903	7, 11, 16
007-612	61	024-911	121	043-841	103		116	130-901	48	150-960	116	244-181	99				
007-620	61	024-914	121	043-842	103	0660-0018	70	130-902	48	150-961	116	244-182	99	5430-00007	23, 24	7310-1302	86
007-635	61	024-916	121	043-845	103	0660-0019	70	130-903	48	150-971	116	244-190	96			7310-1305	85
007-652	61	024-923	121	043-860	103	0660-0038	70	130-904	48	150-991	116	244-191	96	5430-0058	5, 7, 9, 21, 29	7310-2307	15
007-661	61	024-948	121	043-861	103	0660-0042	71, 94,	132-319	37	177-075	35	244-192	96	5430-0100	5, 7, 9, 21	7315-1850	23, 27
007-663	61	024-957	121	046-275	114		102, 133	132-503	37	177-090	35	244-200	94			7410-0023	88
007-665	61	024-999	121	050-200	69	0660-1811	70	132-504	37	177-091	35	244-205	94	5430-30151	23	7410-0024	88
007-670	60	026-005	121	050-205	69	0660-1813	70	132-555	37	177-092	35	5120-0176	27	5430-30152	23	7410-0025	88
007-675	60	026-012	121	050-250	69	0665-2014	84	132-680	40	177-095	36	5120-1238	18	5430-30154	23	7900-0352	29
007-680	60	026-013	121	053-610	65	0665-2017	61, 83	132-681	40	177-124	36	5120-2144	19	5430-3136	29	9282-0009	21
007-685	60	026-014	123	053-611	65	0670-0016	26, 33	132-684	40	177-324	36	5120-2257	11	5510-3003	83	9282-0009	29

Driving the Science of Better.

At Mirion Medical, we partner with medical professionals to better the human condition. From diagnosis through treatment, our diverse solutions enhance the delivery and ensure the safety of healthcare.

For additional information, visit mirion.com/medical



MIRION
MEDICAL



Better Quality Management, Better Care

Our comprehensive Radiation **Therapy and Diagnostic Imaging** solutions enhance the checks and balances that keep cancer detection treatment safe, effective, and ever-improving.

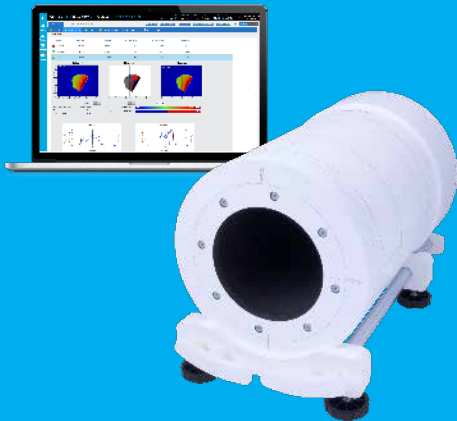

Made Better to Support Better Patient Care

The incomparable engineering and user-focused design of our **Medical Imaging** tables enhance the value of user investment, helping them deliver a quality patient experience for years to come.



Delivering Better Tools for Safer Workspaces

Our **Occupational Dosimetry** products and services remove the worry of radiation from the daily routines of those who are exposed at work.



Empowering Better, Safer Diagnosis & Treatment

From dose preparation to patient administration, our **Nuclear Medicine** solutions and supplies enhance safety and accuracy to aid potentially life-saving imaging and therapy.



Capintec Nuclear Medicine and Molecular Imaging products
better the human condition by protecting people from
exposure during potentially life-saving diagnosis and therapy.

Capintec, Inc.

Phone

+1 (800) 631-3826

+1 201 825-9500

Address

7 Vreeland Road,
Florham Park, New Jersey
07932

capintec@mirion.com



CAPINTEC
A MIRION MEDICAL COMPANY

Copyright © 2024 Mirion Technologies, Inc. or its affiliates. All rights reserved. Mirion, the Mirion logo, and other trade names of Mirion products listed herein are registered trademarks or trademarks of Mirion Technologies, Inc. or its affiliates in the United States and other countries. Third party trademarks mentioned are the property of their respective owners.

MKTG-1329 05/2024