



**CAPINTEC**  
A MIRION MEDICAL COMPANY

ISSUE 4.0



# Nuclear Medicine

and Molecular Imaging  
Devices and Supplies

ISO 13485:2016  
CERTIFIED

# Empowering Better, Safer Diagnosis & Treatment



**CAPINTEC**  
A MIRION MEDICAL COMPANY





# Part of Mirion Medical

The nuclear medicine and molecular imaging portfolios of Capintec and Biodex have come together under Capintec, a Mirion Medical company. Together, we empower better, safer diagnosis and treatment by enhancing safety and efficiency for technologists and physicists through top-quality nuclear medicine solutions.

At Mirion Medical, we partner with medical professionals to better the human condition. From diagnosis through treatment, we enhance the delivery and ensure the safety of healthcare.



**MIRION**  
MEDICAL

## Delivery, Detection and Diagnosis

Dose Calibrators & Accessories .....	4-19
Thyroid Uptake Systems .....	20-24
Well Counters & Radio-TLC .....	26-30
Lung Ventilation Systems & Accessories .....	31-43
Positioning Devices.....	44-45

## Lab Supplies

Shielding & Storage.....	47-74
Lead-lined Cabinets & Enclosures.....	75-84
Sources & Markers.....	85-89
Lab Equipment.....	90-98
Signs, Labels & Tags .....	99-102
Shielded LAF.....	104

## Imaging Quality Assurance

Phantoms.....	105-109
---------------	---------

DELIVERY, DETECTION AND DIAGNOSIS

# Dose Calibration & Accessories

DOSE CALIBRATION & ACCESSORIES



## CRC®-55tR Dose Calibrator

*Provides the speed and accuracy you need to measure and prepare doses*

The Capintec CRC-55tR Dose Calibrator provides the speed and accuracy you need to measure and prepare doses with the reliability and performance you expect. The CRC-55tR calibrator's design includes a menu-driven, color touch screen interface that is easy to learn and use.

The ion chamber is a time-tested, high pressure chamber Capintec design capable of measuring a dose as high as 6 Ci (250 GBq) with high accuracy.

Additional features such as USB/PC communications, printer capabilities, USB flash drive software upgrades and a plug-and-play chamber make the CRC-55tR calibrator integral in improving your department's efficiency.

The innovative functional design of the CRC-55tR unit allows for a large, easy-to-read display that indicates Nuclide Name, Number, Activity, Unit of Measure and Calibration Number.

Entering data through the custom touch screen interface is fast and includes 28 programmable keys. The user can choose from 80 nuclides by simply selecting the nuclide symbol on the touch screen interface.

Other capabilities include storage of reference sources in memory that automatically decay correct for today's time and date. Automated quality control tests and self-diagnostics are built-in with automatic zero and background subtraction making the CRC-55tR calibrator exceptionally easy to use. An optional printer enables the CRC-55tR unit to print full size records and patient tickets with peel off labels for vial and syringe identification.

Mirion Medical Nuclear Medicine solutions offer excellence in energy measurement, customer service, training and support.

## Dose Calibration & Accessories

### Features:

- 8 in. color VGA touch screen display
- Single or optional second plug-and-play chamber capability
- Chamber can be placed 100 feet from the readout unit
- Bilingual (English/Spanish) software
- On-screen display of Nuclide Name, Number, Activity, Unit of Measure and Calibration Number
- Large character, high visibility display
- Over 80 Nuclides with half-lives in memory
- Full alphanumeric touchpad
- Built-in dose calibration, quality control and self-diagnostics
- Automated QC including constancy and linearity programs
- Compatible with Nuclear Medicine Management Systems via USB
- Optional printer for full size NRC records and patient labels for syringes and vials
- USB/PC communications
- Software upgrade via USB or flash drive
- USB printer capability
- Automated geometry and linearity testing
- Capable of dual chambers
- Supports exchange of chambers with the CRC®-55tPET Dose Calibrator
- Chamber energy range: 15 keV to 3 MeV

### Specifications:

- Console Dimensions: 9.5" h x 9" w x 10.5" l (24 x 23 x 27 cm)
- Console Weight: 7.5 lb (3.4 kg)
- Chamber Dimensions: 17.25" h x 6.76" dia. (43.8 x 17.2 cm)
- Chamber Weight: 30 lb (13.6 kg)
- Chamber Well Dimensions: 2.4" dia. x 10" depth (6.1 x 25.3 cm)
- Ionization Chamber:
  - Type: Thin wall, deep well, high pressure
  - Fill Gas: 12 atm Ultra-Pure Argon
- Measurement Range:
  - Type: Auto Ranging
  - Activity:
    - 6 Ci (222 GBq) Tc99m max
    - 2 Ci (74 GBq) F18 max
  - Resolution: .001 MBq (.01  $\mu$ Ci), max
- Display Screen:
  - Type: 8 in. VGA LCD color touch screen display
  - Format: Direct reading in Bq or Ci
  - Bq/Ci Reading: User selectable or fixed
  - Values Displayed: Nuclide name (atomic symbol, mass number), calibration number
- Electrometer:
  - Accuracy: Better than  $\pm$  2%
  - Linearity: Within  $\pm$  2%
  - Response Time: Within 2 seconds, 4 to 16 seconds for very low activity samples

- Repeatability of Measurement:
  - Within  $\pm$  1% within 24 hours during which time the calibrator is continuously in operation
- Tests:
  - Diagnostics: Full test of program, system memories
  - Daily: Auto Zero, Auto Background Adjust, Data Check, Accuracy and Constancy, Voltage Test
  - Enhanced: Linearity, Geometry, Strip QC
- Nuclear Data:
  - Nuclide Keys: 28 programmable keys
  - System Memory: Over 80 nuclides (cal number and half-life)
- Standard Source Data
  - System Memory: Co-57, Co-60, Ba-133, Cs-137 standard sources
- Molybdenum-99 Assay:
  - Methods: CapMac and canisters
  - Measured Values: Mo-99 elution, Tc-99m, Tc-99m/Mo-99 Ratio
- PC Port:
  - Interface: RS-232 and USB
  - Compatibility: Standard Nuclear Medicine Management Systems
- Printer (Optional):
  - Interface: RS-232 and USB
  - Type: Epson Roll, Epson Slip or Okidata full size dot matrix
  - Printing Options: Full size test reports. Measured results on tickets
- Power Requirements: 100-240 VAC (50/60 Hz) 90 MA
- Cable Length\*: 12 ft (3.7 m)
  - Power\*: 6 ft (1.8 m)
  - Printer: 6 ft (1.8 m)



\*Longer cables are available. Consult factory.

**5130-3234** CRC-55tR Dose Calibrator

#### Related:

- 5430-0058** Epson Roll Printer
- 5430-0100** Epson Ticket Printer
- 7120-1199** CRP-200 Dose Tickets & Labels
- 5130-2046** CAP-MAC-S® Moly Assay Canister for Syringes
- 5130-0006** Moly Assay Canister
- 7300-2004** Chamber Well Insert
- 7300-2450** Environmental Shield
- 7300-2005** Dipper

## Dose Calibration & Accessories



### CRC®-55tPET Dose Calibrator

*Introducing the standard for speed and accuracy in measuring PET isotopes*

The Capintec CRC-55tPET dose calibrator combines the ultimate features with the quality and versatility that you've come to expect in one of the industry's finest packages. Using the menu-driven, color touch screen interface, the CRC-55tPET calibrator's reduced chamber pressure and increased bias voltage increases the maximum activity range for high energy PET isotopes. The CRC-55tPET unit's performance and reliability have been designed to meet the demanding needs for speed and accuracy in the preparation and measurement of doses in any laboratory environment.

The enhanced 55t software supports dual chamber technology with an innovative functional design that includes a large, easy-to-read display that specifies Nuclide Name, Number, Activity, Unit of Measure and Calibration Number.

Entering data through the custom touch screen interface is fast and includes 28 programmable keys. The user can select from 80 nuclides by simply selecting the nuclide symbol on the touch screen interface.

Additional capabilities include storage of reference sources in memory that automatically decay corrects for today's time and date. Automated quality control tests and self-diagnostics are built-in with automatic zero and background subtraction making the CRC-55tPET calibrator exceptionally easy to use. An optional printer enables the CRC-55tPET unit to print full size records and patient tickets with peel off labels for vial and syringe identification.

¿Se habla español? The 55t family is bilingual English/Spanish software!

Features including USB/PC communications, printer capabilities, USB flash drive software for upgrades and plug-and-play chamber make the CRC-55tPET calibrator an integral tool in improving your department's efficiency.

Mirion Medical Nuclear Medicine solutions offer excellence in energy measurement, customer service, training and support.

## Dose Calibration & Accessories

### Features:

- 8 in. color VGA touch screen display
- USB/PC Communications
- Software upgrade via USB or flash drive
- USB printer capability
- Single or optional second plug-and-play chamber with mixed chamber capability
- Chamber can be placed 100 feet from the readout unit
- Bilingual (English/Spanish) software
- On-screen display of Nuclide, Activity, Unit of Measure and Calibration Number
- Large character, high visibility display
- Full alphanumeric touchpad
- Built-in dose calibration, quality control and self-diagnostics
- Has a maximum activity up to 20 Ci of F-18
- Compatible with Nuclear Medicine Management Systems via USB
- Optional printer for regulatory records and patient labels for syringes and vials
- Over 80 nuclide symbols and half-lives in memory
- Automated geometry and linearity testing

### Specifications:

- Console Dimensions: 9.5" h x 9" w x 10.5" l (24 x 23 x 27 cm)
- Console Weight: 7.5 lb (3.4 kg)
- Chamber Dimensions: 17.25" h x 6.76" dia. (43.8 x 17.2 cm)
- Chamber Weight: 30 lb (13.6 kg)
- Chamber Well Dimensions: 2.4" dia. x 10" depth (6.1 x 25.3 cm)
- Ionization Chamber:
  - Type: Thin wall, deep well
  - Fill Gas: 5 atm Ultra-Pure Argon
- Measurement Range:
  - Type: Auto Ranging
  - Activity: 20 Curies of F-18
  - Resolution: 0.1  $\mu$ Ci (0.01 MBq), max.
- Display Screen:
  - Type: 8 in. VGA LCD color touch screen display
  - Format: Direct reading in Ci or Bq
  - Bq/Ci Reading: User selectable or fixed
  - Values Displayed: Nuclide name (Atomic symbol, Mass number), calibration number
- Electrometer:
  - Accuracy: Better than  $\pm$  2%
  - Linearity: Within  $\pm$  2%
  - Response Time: Within 2 seconds, 4 to 16 seconds for very low activity samples
  - Bias Voltage: +500V

- Repeatability of Measurement:
  - Within  $\pm$  1% within 24 hours during which time the calibrator is continuously in operation
- Overall Accuracy:
  - Accuracy Determined By:
    1. Calibration for the specific nuclide and the sample configuration
    2. Accuracies of standard sources used for calibration of electrometer
- Tests:
  - Diagnostics: Full test of program, system memories
  - Daily: Auto Zero, Auto Background, Voltage Test, Data Check, Accuracy and Constancy
  - Enhanced: Linearity, Geometry
- Nuclear Data:
  - Nuclide Keys: 28 programmable keys
  - System Memory: Over 80 nuclides (Cal number and half-life)
- Standard Source Data
  - System Memory: Co-57, Co-60, Ba-133, Cs-137, Na-22 standard sources
- PC Port:
  - Interface: RS-232 and USB
  - Compatibility: Standard Nuclear Medicine Management Systems
- Printer (Optional):
  - Interface: RS-232 and USB
  - Type: Epson Roll, Epson Slip or Okidata full size dot matrix
  - Printing Options: Full size test reports, measured results on tickets
- Power Requirements: 100-240 VAC (50/60 Hz) 100 mA
- Cable Length\*: 12 ft (3.7 m)
  - Power\*: 6 ft (1.8 m)
  - Printer: 6 ft (1.8 m)



\*Longer cables are available. Consult factory.

- 5130-3235** CRC-55tPET Dose Calibrator
- 5130-2238** CRC-55tPET Multiple Chamber Option

### Related:

- 7300-2903** CRC-PS Positron Shield
- 5430-0058** Epson Roll Printer
- 5430-0100** Epson Ticket Printer
- 7120-1199** CRP-200 Dose Tickets & Labels
- 7300-2004** Chamber Well Insert
- 7300-2450** Environmental Shield
- 7300-2005** Dipper

## Dose Calibration & Accessories



### CRC®-55tW Dose Calibrator Well Counter

*A combination of the CRC®-55tR Dose Calibrator and Well Counter*

As a combination of the CRC-55tR Dose Calibrator and Well Counter, the CRC-55tW dose calibrators provide advanced features with the speed and accuracy you need to measure activity and prepare doses. Its ion chamber is one of the time-tested, high pressure well designs by Capintec capable of measuring a dose as high as 6 Ci (250 GBq) with high accuracy. The CRC-55tW calibrator features a helpful chamber plug-and-play capability.

For wipe testing, the CRC-55tW calibrator allows the user to define specific counting procedures (protocols) with trigger levels for work, patient, unrestricted areas and sealed source leak tests. The CRC-55tW unit also performs counting functions for wipe tests in as little as six seconds at activities as low as 1 nCi. Low activities are measured with a drilled well high sensitivity Sodium Iodide (NaI) detector.

The well counter includes a 256 channel MCA which provides detailed spectrum for identification and analysis. Manual and automatic ROI selection are available.

The chamber and counter of the CRC-55tW calibrator are combined in a menu-driven, touch screen interface that is easy to learn and use.

Reports software, for the CRC-55tW unit, archives well counter data for quality assurance procedures, wipe measurements and laboratory tests. Well counter reports are stored and searchable by date range for later viewing or printing. Wipe tests are searchable by date range, wipe type, and activity.

Mirion Medical Nuclear Medicine solutions offer excellence in energy measurement, customer service, training and support.



## Dose Calibration & Accessories

### Features:

- 8 in. VGA touch screen color display
- USB/PC Communications
- Software upgrade via USB or flash drive
- USB printer capability
- Chamber plug-and-play capability
- 28 programmable nuclide keys
- Built-in dose calibration, quality control and self-diagnostics
- Over 80 nuclides in memory
- Automatic chamber QC including linearity
- Hard copy records of data available from optional printer
- Compatible with nuclear medicine information management systems via USB
- 256 channel MCA with detailed spectrum for identification analysis
- Well counter for wipe tests
- User-definable protocols for wipe testing
- Automated well QC including Chi-Square and MDA
- Manual and automatic ROI
- Includes a pre-set key for F-18 measurements
- Reports: Well counter reports for autocalibration, system test, MDA, and Chi-Square are archived and searchable by date, type, and activity
- Automated linearity testing and geometry testing

### Specifications:

- Console Dimensions: 9.5" h x 9" w x 10.5" l (24 x 23 x 27 cm)
- Console Weight: 7.5 lb (3.4 kg)
- Chamber Dimensions: 17.25" h x 6.76" dia. (43.8 x 17.2 cm)
- Chamber Weight: 30 lb (13.6 kg)
- Chamber Well Dimensions: 2.4" dia. x 10" depth (6.1 x 25.3 cm)
- Well Counter Dimensions: 9.38" h x 6" dia. (23.8 x 15.2 cm)  
Well Counter Weight: 15.2 lb (6.9 kg)  
Well Diameter: .67" (1.7 cm)  
Well Depth: 1.5" (3.8 cm)  
Cable Length: 9 ft (2.7 m)
- Well Detector  
Type: Sodium Iodide (NaI) drilled-well crystal detector  
256 Channel MCA, manual and automatic ROI  
Warning Trigger Levels: User-definable  
Tests: Daily test, energy calibration, and reproducibility  
Enhanced QC includes Chi-Square and MDA
- Ionization Chamber  
Fill Gas: 12 atm Ultra-Pure Argon  
Measurement: Auto ranging  
Activity Range:  
6 Ci (222 GBq) Tc99m max  
2 Ci (74 GBq) F18 max  
Resolution: .001 MBq (.01  $\mu$ Ci)  
Response Time: Within 2 seconds, for low activity sample,  
4 to 16 seconds  
Tests: Daily tests include Auto Zero, Background Adjustment,  
Voltage Test, Data Check, Accuracy and Constancy  
Enhanced QC includes linearity, geometry, strip QC

- Display Screen  
Type: 8 in. VGA LCD color touch screen display  
Bq/Ci Reading: User selectable or fixed  
Activity Display: Selected radionuclide, calibration number, measured activity and display units (Bq/Ci)  
Count Rate Values: Wipe results
- Electrometer  
Accuracy: Better than  $\pm 2\%$   
Linearity: Within  $\pm 2\%$
- Repeatability of Measurement  
Within  $\pm 1\%$  within 24 hours during which time the calibrator is powered at all times
- Nuclide Data  
Nuclide Setting Keys: 28 programmable keys  
System Memory: Over 80 nuclides (cal number and half-life)  
A pre-set key measures up to 2.0 Ci (74.0 GBq) of F-18
- Standard Source Data  
System Memory: Co-57, Co-60, Ba-133, Cs-137
- Molybdenum-99 Assay  
Methods: CapMac and canisters  
Measured Values: Mo-99 elution, Tc-99m, Tc-99m/Mo-99 ratio
- PC Port  
Interface: RS-232 and USB  
Compatibility: Standard Nuclear Medicine Management Systems
- Printer  
RS-232 and USB Ports  
Epson Roll, Epson Slip or Okidata dot matrix
- Tests  
Diagnostics: Full test of program, system memories
- Power Requirements: 100-240 VAC (50/60 Hz) 100 mA
- Cable Length\*: 12 ft (3.7 m)  
Power\*: 6 ft (1.8 m)  
Printer (optional): 6 ft (1.8 m)



\*Longer cables are available. Consult factory.

**5130-2216** CRC-55tW Dose Calibrator

#### Related:

- 5430-0058** Epson Roll Printer
- 5430-0100** Epson Ticket Printer
- 7120-1199** CRP-200 Dose Tickets & Labels
- 7300-2004** Chamber Well Insert
- 7300-2450** Environmental Shield
- 7300-2005** Dipper



## Dose Calibration & Accessories

DOSE CALIBRATION & ACCESSORIES



### CRC®-77tHR Dose Calibrator

*High-activity measurements  
for isotope production environments*

The CRC-77tHR calibrator's performance and reliability have been designed to meet the unique and demanding needs of the isotope manufacturing and radiopharmaceutical production environments.

The software is designed for rapid repeatable measurement functions often required in production, and includes a fully automated Quality Assurance Program. Hardware is carefully designed to minimize the impact of high radiation fields upon electronics. A touch screen user interface provides a user-friendly and efficient workflow.

Some features include a high activity range of over 400 Curies for Tc-99m, USB/PC communications, and pre-defined communication protocols for fast and easy system interface.

We offer a full line of related Capintec products to safely use the CRC-77tHR calibrator within your hot cell or hood environment.

#### Features:

- Maximum Activity for 77tHR is 400 Curies (15 TBq)
- Radiation resistant design
- Custom length liners and dippers available to match your hot cell dimensional requirements
- 8 in. color VGA touch screen display
- On-screen display of Nuclide Name, Number, Activity, Unit of Measure and Calibration Number
- Large character, high visibility display
- Over 80 nuclides with half-lives in memory
- Full alphanumeric touchpad
- Built-in dose calibration, quality control and self-diagnostics
- Automated QC including constancy and linearity programs
- Compatible with Nuclear Medicine Management Systems via USB
- Optional printer for full size hard copy records
- USB/PC communications
- Software upgrade via USB or flash drive
- USB printer capability
- Automated geometry and linearity testing

## Dose Calibration & Accessories

### Specifications:

- Console Dimensions: 9.5" h x 9" w x 10.5" l (24 x 23 x 27 cm)
- Console Dimensions: 9.5" h x 9" w x 10.5" l (24 x 23 x 27 cm)
- Console Weight: 7.5 lb (3.4 kg)
- Chamber Dimensions: 17.25" h x 6.76" dia. (43.8 x 17.2 cm)
- Chamber Weight: 30 lb (13.6 kg)
- Chamber Well Dimensions: 2.4" dia. x 10" depth (6.1 x 25.3 cm)
- Ionization Chamber:
  - Type: Thin wall, deep well
  - Fill Gas: 5 atm Ultra-Pure Argon
- Measurement Range:
  - Type: Auto Ranging
  - Activity: 15 TBq (400 Ci), max Tc-99m, 4.8 TBq (130 Ci), max F-18
  - Resolution: 0.01 MBq (10  $\mu$ Ci), max.
  - Energy: 15 keV to 3 MeV
  - Not recommended for activity measurements < 100  $\mu$ Ci
- Display Screen:
  - Type: 8 in. VGA LCD color touch screen display
  - Format: Direct reading in Bq or Ci
  - Bq/Ci Reading: User selectable or fixed
  - Values Displayed: Nuclide name (atomic symbol, mass number), calibration number
- Electrometer:
  - Accuracy: Better than  $\pm$  2%
  - Linearity: Within  $\pm$  2%
  - Response Time: Within 3 to 4 seconds, 5 to 25 seconds for low activity samples
- Repeatability of Measurement:
  - Within  $\pm$  1% within 24 hours during which time the calibrator is continuously in operation
- Tests:
  - Diagnostics: Full test of program, system memories
  - Daily: Auto Zero, Auto Background Adjust, Data Check, Accuracy and Constancy, Voltage Test
  - Enhanced: Linearity, Geometry
- Nuclear Data:
  - Nuclide Keys: 28 programmable keys
- Standard Source Data:
  - System Memory: Co-57, Co-60, Ba-133, Cs-137 standard sources
- PC Port:
  - Interface: USB
  - Compatibility: Standard Nuclear Medicine Management Systems

- Printer (Optional):
  - Interface: USB
  - Type: HP Inkjet
  - Printing Options: Full size test report
- Power Requirements: 100-240 VAC (50/60 Hz) 100 mA
- Cable Length: 12 ft (3.7 m)
- Power: 6 ft (1.8 m)



**5130-30261** CRC-77tHR Dose Calibrator

**Related:**

- 7300-2903** CRC-PS Positron Shield
- 5120-2258** Custom Length Dipper
- 5120-2257** Custom Length Liner
- 5126-2001** Positron Shield Stand
- 5130-30251** CAP-Lift

## Dose Calibration & Accessories



### CRC®-PC Smart Chamber

*Network ready with remote connectivity*

The CRC-PC Smart Chamber combines the well-known and highly reliable measurement Capintec™ chamber with an innovative web-based user interface to meet today's business requirements. Remote connectivity and network-ready interface set the Smart Chamber apart as the most advanced in dose calibration.

The CRC-PC Smart Chamber is available in two fill pressures. For unit dose hot labs, the HL model provides excellent low activity sensitivity while covering a wide clinical range of activities. For radiopharmacies, the lower fill pressure of the pharmacy RPh model extends the activity range to accommodate the higher activity yields of today's generators and cyclotron sites.

The innovative functional design of the PC Smart Chamber provides a small footprint, and direct interface to Nuclear Medicine Management Systems with remote viewing capability.

Additional features include Ethernet software upgrades, plug-and-play chamber, and user adjustable threshold for faster response.

Mirion Medical Nuclear Medicine solutions offer excellence in energy measurement, customer service, training and support.



## Dose Calibration & Accessories

### Features:

- Connects to network infrastructure so that display can be viewed from any network PC (remote viewing)
- Direct interface to Nuclear Medicine Management Systems - no readout required
- Ethernet Communications
- Automated QC
- Software upgrade via Ethernet interface
- Built-in database to store QC, Moly and User Log
- Power over Ethernet or USB port
- User adjustable threshold for faster response times
- Small footprint
- User manual viewable on PC

### Specifications:

- Console Dimensions: 9.5" h x 9" w x 10.5" l (24 x 23 x 27 cm)
- Console Dimensions: 9.5" h x 9" w x 10.5" l (24 x 23 x 27 cm)
- Console Weight: 7.5 lb (3.4 kg)
- Chamber Dimensions: 17.25" h x 6.76" dia. (43.8 x 17.2 cm)
- Chamber Weight: 30 lb (13.6 kg)
- Chamber Well Dimensions: 2.4" dia. x 10" depth (6.1 x 25.3 cm)
- Chamber Dimensions 18.1" h x 6.76" w x 2.75" dia. (45.8 x 17.17 x 2.75 cm)
- Chamber Liner Insert: 2.74" dia. (6.9596 cm)
- Chamber Weight: 39.3 lb (17.8 kg)
- Well Dimensions: 2.4" dia. x 10" depth (6.1 x 25.4 cm)
- CRC-PC Smart Chamber:
  - HL System: Item #5130-30255
  - RPh System: Item #5130-30256
  - HL Chamber: Item #5130-20253
  - RPh Chamber: Item #5130-20254
- Ionization Chamber:
  - Type: Thin wall, deep well, sealed and pressurized
  - Fill Gas: Ultra-Pure Argon
- Electrometer:
  - Accuracy: Better than  $\pm 2\%$
  - Linearity: Within  $\pm 2\%$
  - Response Time: Within 2 sec, 4 to 16 sec for very low activity samples
- Repeatability of Measurement:
  - Within  $\pm 1\%$  within 24 hours during which time the calibrator is continuously in operation
- Tests:
  - Diagnostics: Full test of program, system memories
  - Daily: Auto Zero, Auto Background Adjust, Data Check
  - Accuracy and Constancy, Voltage Test
- Nuclear Data:
  - 30 User Nuclides
  - Over 80 built-in nuclides (cal number and half-life)

- Measurement Range:
  - Type: Auto Ranging
  - HL (hot Lab) 6 Ci Tc-99m, 2 Ci F-18
  - RPh (pharmacy) 72 Ci Tc-99m, 20 Ci F-18
- Standard Source Data:
  - System Memory: Co-57, Co-60, Ba-133, Cs-137, Na-22 standard sources
- Molybdenum-99 Assay:
  - Methods: Canisters and CAP-MAC
  - Measured Values: Mo-99 elution, Tc-99m, Tc-99m/Mo-99 Ratio
- PC Port:
  - Interface: Ethernet
  - Compatibility: Standard Nuclear Medicine Management Systems
- PC Power Requirements:
  - 100-240 VAC (50/60 Hz) 3 A max
- Chamber Power:
  - USB: 5 VDC, 0.5 A
  - Power over Ethernet (PoE): 48 VDC, 0.35 A



- 5130-20253** CRC-PC Smart Chamber HL Chamber
- 5130-20254** CRC-PC Smart Chamber RPh Chamber

### Related:

- 5130-0006** Molly Assay Canister
- 7300-2450** Environmental Shield
- 7300-2004** Chamber Well Insert
- 5130-2046** CAP-MAC-S® Moly Assay Canister for Syringes
- 7300-2005** Dipper

## Dose Calibration & Accessories

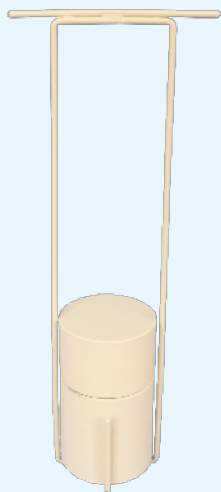

### Moly Assay Canister

*Measures Molybdenum Content of Tc-99m*

Verify that the amount of Mo-99 contamination in your vial of Tc-99m is within NRC or state regulatory limits with a molybdenum assay canister. Use it with all Capintec dose calibrators. The kit has a lead canister and a wire basket to ensure proper placement of the Tc-99m vial in the ionization chamber. It is designed to accommodate all vials up to 30 ml without changing parts or dose calibrator settings.

#### Specifications:

- Overall height including wire handle: 10.06" (25.5 cm)
- Handle width: 3.75" (9.5 cm)
- Canister diameter: 2.10" (5.3 cm)
- Canister height: 3.68" (9.3 cm)
- Lead Thickness: 0.5" (1.2 cm)

5130-0006 Moly Assay

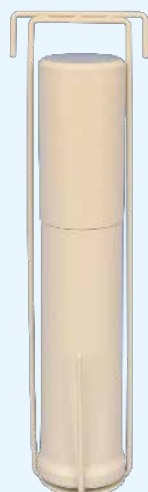

### CAP-MAC-S® Moly Assay Canister For Syringes

*Measures Mo-99 in Tc-99m unit doses*

The CAP-MAC-S kit is similar to the moly assay canister, but is specially designed for unit-dose syringes of Tc-99m labeled radiopharmaceuticals. Use the CAP-MAC-S kit to verify that the amount of Mo-99 contamination in unit doses is within NRC or state regulatory limits. It fits all Capintec dose calibrators. The CAP-MAC-S kit has a lead canister and a wire basket to ensure proper placement of the syringe in the ionization chamber. It is designed to accommodate all syringes up to 30 ml without changing parts or dose calibrator settings.

5130-2046 CAP-MAC-S

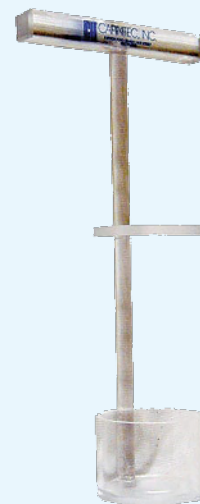

### Vial/Syringe Dipper

*Ensures proper placement every time*

Every calibrator comes with a sample holder. Sometimes known as the dipper, this holder is specially designed to hold syringes and vials of all sizes. You can order additional sample holders as a separate item.

The sample holder offers a safe, convenient way to hold a vial or syringe during activity measurement. Proper placement in the dose calibrator is assured every time. New material in the shaft reduces breakage for longer life, and eliminates the attenuation problems of low-energy gamma emissions that occur with other dippers. Syringe inserts available for tuberculin syringes (1.0 ml).

7300-2005 Dipper

## Dose Calibration &amp; Accessories



### Environmental Shield

*Nine Interlocking lead rings surround chamber*

Reduce background radiation more than 10 times with the environmental shield. Fitting any Capintec CRC dose calibrator with a remote ionization chamber, the shield consists of nine interlocking lead rings that surround the chamber. Uniform wall thickness (4 cm standard, or 1 1/2") also reduces radiation exposure during calibration. The lead contains 3% antimony for added strength. For use with CRC-25R, CRC-25W, CRC-712M units, and CRC® Ultra.

**Specifications:**

- Weight: 310 lb (141 kg)

**7300-2450** Environmental Shield



### Positron Shield

*Constructed with nine sets of split lead rings, provides maximum radiation protection*

Constructed of nine sets of 2 1/4" (6 cm) thick lead split rings for full shielding of a dose calibrator chamber. The positron shield gives maximum radiation protection when working with 511 keV nuclides. The shield can either be flush mounted to a work surface or mounted on a table or cabinet.

**Specifications:**

- Weight: 560 lb (254 kg)

**7300-2903** Positron Shield



### Positron Shield Stand

*Solidly built to support a Capintec dose calibrator encased in the Positron Shield*

**Features:**

- 3-Legged stand made of arc-welded steel
- Capintec will custom design to meet your exact specifications

**Specifications:**

- Standard Range of height with adjustable feet is 22.875" to 25.375" (58 x 64 cm)

**5126-2001** Positron Shield Stand

## Dose Calibration & Accessories



### Chamber Well Insert

*Protects chamber well, easily washable with decontaminant*

Every Capintec dose calibrator in the CRC family already comes with this protective chamber well insert. If it becomes contaminated, you can easily remove it for washing with a decontaminant. Or, you can buy an extra chamber well insert to use until the other one decays to background levels.

The chamber well insert is made of clear, tough plexiglass for improved durability, reduced breakage, and longer life.

7300-2004 Liner



### Copper Liner

*Eliminates variations in readings when measuring I-123*

This liner eliminates variations in readings when measuring I-123. It receives a standard dipper.

#### Specifications:

- Dimensions: 11.75" l x 2.75" dia. (29.8 x 5 cm)

5120-2286 Copper Liner



### PET Auxiliary Shield

*PET auxiliary shield for the 55tW and CAPRAC-t counter*

The Well Auxiliary Shield is made with 1.5" thickness for shielding and sits on its own supporting base. The shield fits snugly around the well chamber for a total of 2" and can be easily installed or removed, as needed.

#### Specifications:

- Dimensions: 15.625" h x 7.5" w x 6.75" d (39.6 x 19 x 17 cm)
- Weight: 90 lb (40.8 kg)

5420-2141 PET Auxiliary Shield



## Dose Calibration &amp; Accessories



### Auxiliary Shield

*CAPRAC®-t, 55tW, 25W, Ultra Well*

The CAPRAC Wipe Test/Well Counter is a very sensitive system which uses a NaI detector that can be affected by high background activity or changes in the room background during counting periods. If the CAPRAC is used in a location which might have a high background, an Auxiliary Shield can be used to reduce background levels. The Auxiliary Shield walls and top are 0.5" thick. The top lid has a handle for easy removal. The shield fits snugly around the well chamber and can be easily installed or removed.

#### Specifications:

- Dimensions: 9 3/4" h x 4" w (24.7 x 10.1 cm)
- Weight: 22 lb (10 kg)

**5420-2072** Well Auxiliary Shield, CAPRAC-t, 55TW



### CALICHECK Linearity Test Kit

The innovative CALICHECK linearity test kit provides system testing of a dose calibrator in less than 10 minutes. The CALICHECK attenuates Tc-99m by known values.

Simulating decay for a range of a few hours up to four days, the CALICHECK eliminates the need to fractionate eluants or decay them for several days while periodically collecting data.

The unique design of seven color-coded, lead-wrapped tubes allows for accurate testing. They are complete with their own storage container and record-keeping sheets with easy-to-follow instructions.

#### Features:

- Performs linearity
- Accurately simulates decay down to 10  $\mu$ Ci
- Results comparable to standard linearity tests
- Meets NRC and state standards

**5120-2144** CALICHECK Linearity Kit

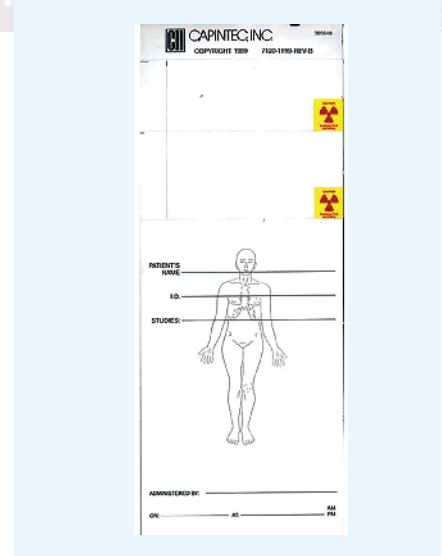

### CRP-200 Dose Tickets and Labels

*Duplicate tickets with peel-off, self-stick labels*

By popular demand we have added the "little patient" to this ticket making it possible to mark the site of injection. Also included, for your convenience, is a place to write the patient's Name, I.D. number, Study performed, who administered the dose and when used with the CRC-25R, 25W, or Ultra, one pass through the printer, produces two copies of each ticket and two easy to remove peel-off labels.

All tickets and labels are easily separated after printing. Use them for patient charts, department log books, and syringe or vial shields. A special adhesive makes labels easy-to-remove after use.

**7120-1199** CRP & CRC 200 Dose Tickets and Labels 250/pkg.

**7120-1240** CRP & CRP 200C Dose and Label Tickets 1500/case

## Dose Calibration & Accessories



### CAP-Lift™

*Hands-free dose measurements*

#### Features:

- Reduces hand and body exposure
- Stainless steel construction
- Auto return to elevated dose reception position
- Small size hand control and/or optional foot switch
- Standard and optional custom lengths
- Color-coded supply lines
- Perfect alignment with all Capintec dose calibrators
- Pneumatic system for faster operations
- No electrical power needed
- Foot pedal accessory included

#### Specifications:

- Height of lift mechanism: 19.25" (48.9 cm) from top of chamber
- Diameter of lift stand: 6" (15.25 cm) at top of chamber
- Travel: 8" (20.3 cm) (Standard) Custom travel lengths available for situations where lift stand is not sitting directly on the chamber
- Control Box Dimensions: 4" h x 4" w x 2" d (10.1 x 10.1 x 5 cm)

**5130-30251** Standard CAP-Lift

**Related:**  
**5130-20252** Foot Pedal

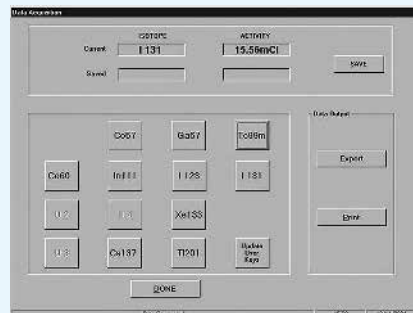

### CRC-55t (R, W & PET) PC Series Communications Software

*Fast and easy data acquisition - track, record and store dose calibrator measurements on your PC*

CRC® PC Communications software will allow for faster and easier data acquisition and storage to your computer. Measurement data, including isotope name and activity, will be transmitted and stored on your PC via an RS232 interface port and the Dose-Link Software package. Ideal for maintaining regulatory compliance, research studies or use in production facilities.

The PC Communications software will create an interface between your CRC-55t (R, W & PET) dose calibrator and your PC. The Dose Link program has four modes of operation:

#### Acquire and Store Data

Each second the name and activity of the isotope selected on the dose calibrator console will be updated by the program. This data can be saved and exported to an Excel spreadsheet.

#### Repetitive Acquisitions

Following user-defined parameters of time intervals and number of measurements, activity and isotope data are acquired and saved. The data can then be printed or exported. Great for performing quarterly linearity tests (you don't even have to be there).

#### Maximum Activity Acquisition

The activity and isotope are updated and displayed at time intervals defined by the user, when data acquisition is stopped, the maximum activity and time will be saved and can be printed or exported.

The CRC PC Communications software is easy to install, easy to use and almost as cost conscious as you are. Help your department maintain accurate record keeping without breaking the department budget.

**0960-0183** PC Communication Software Disc;  
CRC-55t (R, W & PET)

## Dose Calibration & Accessories



### Epson Roll Printer

For CAPRAC-t, CRC-25W, CRC-55tW, CAPRAC, CAPRAC-R

An Epson printer is provided as an option for the CAPRAC-t, Caprac, Caprac-R, CRC-25W, CRC-55tW Wipe Test/Well Counters. This sturdy, high-quality printer provides graphic output with wipe reports, showing the peak energy range of the nuclides on the wipe. The printer utilizes a black/red ribbon to report wipes that are higher than the trigger levels for contamination. Abnormal values are printed in red for easy/fast identification.



### Epson Ticket Printer

Allows individual tickets to be positioned easily for printing

This hard-working printer made by Epson is offered as an option for the CRC-25 and CRC-55t Families of Dose Calibrators, CRC-Beta Enhanced Counter, CAPRAC and the CAPRAC-R Well/Wipe Counters. It allows individual tickets to be positioned easily for printing. The printer automatically aligns the ticket and after printing feeds it out the back. Although designed for tickets, standard paper can be used and is printed along one side. Suggested tickets for the Ticket Printer are the CRP-200 and CRP-700.



5430-0058 Epson Roll Printer

**Related:**

9282-0009 Paper, 12/rolls

2001-0055 Printer Ribbon



5430-0100 Epson Ticket Printer

## DELIVERY, DETECTION AND DIAGNOSIS

# Thyroid Uptake Systems

## Captus® 4000e Thyroid Uptake System

*Large touch screen interface. Fully integrated DICOM*

The Captus 4000e unit is a comprehensive Nuclear Medicine Measurement System, with specific software modules for thyroid uptake, bioassay, wipe tests, automated quality assurance tests, and isotope library. The system includes a fully functional 1024 channel MCA with auto and manual calibration. Timed activity mode features a programmable repetitive timed measurement program. Improved menu-driven workflow and large 20" color touch screen streamlines user interface.

The optional fully integrated DICOM interface communicates directly with hospital information systems and can transfer patient, wipe test, and QC data. Custom Protocol is included as standard, and Microsoft Office Professional 32-bit software is optional.

The improved stand provides ergonomically adjustable monitor and easy-to-position articulating collimator arm. Four sided comfortable handle grips and swivel wheels ensure easy mobility. PC can be attached to either right or left side to optimize workspace.

### Features:

- Color touch screen user interface
- Large 20" all-in-one touch screen computer
- Optional fully integrated DICOM interface for patient data, QC and wipe tests
- Custom Protocol included as standard
- Ergonomically designed mobile stand
- Articulating arm with wide range of motion
- Medical-grade Corian countertop with document storage shelf
- Secure neck phantom storage location
- Source holder for reproducible QC positioning
- Microsoft Office Professional 2010 option

### SOFTWARE:

#### Diagnostics and Tests

- Fully automated Quality Assurance Section includes energy calibration, zero adjust, gain adjust, detector efficiency, detector resolution, chisquare, constancy, and MDA
- Manual calibration available in MCA module

#### Thyroid Uptake

- Provides four predefined protocols
- Supports both capsule and liquid dose formats
- Dose may be pre-counted before patient assignment
- Predose measurement option
- Normal range option

#### Wipe Tests

- Setup for multiple groupings
- Isotope identification available
- Spectrum is displayed for each wipe
- Activity exceeding trigger levels flagged in red



### MCA

- 1024 channels
- Automated and manual calibration selection
- Preset or user defined ROI
- Count set by real time, live time, or total peak counts
- Timed activity feature enables predefined continual repetitive measurements

### DICOM Interface (Optional)

- Fully integrated interface with Captus 4000e System
- Retrieve patient data from worklist
- Upload patient, wipe test, and QA reports

### Bioassay

- Monitors Staff for I-123, I-125, and I-131 exposure
- User defined action levels for each isotope
- Individual and summary reports available

### Custom Protocol

- Create Custom Measurement Sequence
- Customizable Reports

### Reports

- Reports include full spectrum graphics
- Thyroid report includes time vs. uptake value graph
- Data is archived
- Reports can be printed or saved as a .pdf file

### POWER:

#### Line Voltage

- 120 VAC, 60 Hz, 2.6 AMP
- 230 VAC, 50 Hz, 1.1 AMP
- Isolation Transformer with hospital grade cord and plug

## Thyroid Uptake Systems

### SPECIFICATIONS:

#### Thyroid Uptake Stand

- Ergonomically designed floor stand
- Medical-grade Corian countertop with shelf
- Adjustable height PC stand, left or right side mounting
- Articulating arm with 34" vertical range of travel and 220° collimator rotation
- Protective cable management system
- Neck phantom storage location
- Fully protected internally routed cables
- Four heavy-duty locking casters that swivel 360°
- Isolation transformer for patient and user safety
- QA source holder for reproducible geometry

#### Computer

- 20" All-in-One Touch Screen Flat Panel Computer
- Windows 10 Platform

#### Printer

- Color Ink Jet printer

#### Uptake Detector

- 2" dia. 14-pin NaI(Tl) detector with 1.55" depth and 0.66" dia. well
- Flat field collimator meets ANSI N44.3, IAEA
- Precision measurement and alignment rod, which measures distance directly to thyroid

#### Well Counter

- 2" dia. NaI(Tl) well detector with 1.55" depth and 0.66" dia. well
- 1" lead well shield with brass liner
- (Optional 2" shield available)

#### Multichannel Analyzer Interface PC Board

- Two detector inputs
- 1024 Channels
- Maximum count rate: 200,000 cps at 5%
- Count Rate Linearity: Within 2% up to 150,000 cps
- ROIs automatic or manual
- Differential Linearity <2% over the top 98% of channels
- Integral Linearity <1% over the top 98% of channels
- Presets live time, real time, total counts
- Automatic peak finding
- Software controlled lower level discriminator

#### Thyroid Uptake Stand Dimensions

- Closed Storage Position: 56" h x 28" w x 32" d (142 x 71 x 81 cm)
- Arm able to extend 36" (91 cm) horizontally beyond shelf
- Vertical travel 25" to 63" (64 to 160 cm)
- Weight: Uptake System: 340 lb (154 kg)
- Weight with 1" Shielded Well: 410 lb (186 kg)
- Weight with 2" Shielded Well: 540 lb (245 kg)

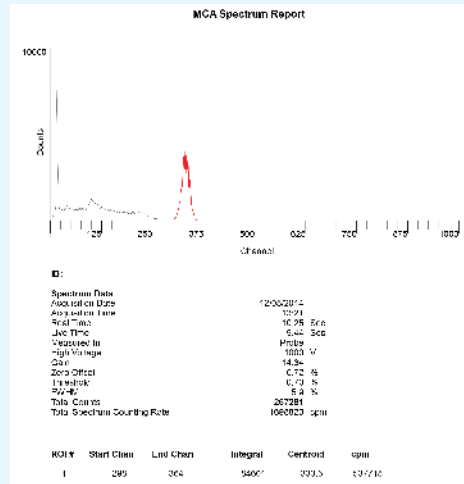

#### Captus 4000e Reports

Reports include color graphics and isotope spectrum. Thyroid report includes time vs. uptake value graph. Out of range results are flagged. Reports can be printed or saved as .pdf files.

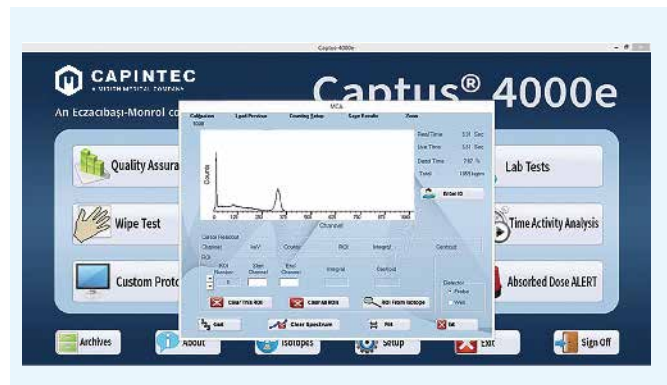

- 5430-30151** Captus 4000e Thyroid Uptake System
- 5430-30152** Captus 4000e Thyroid Uptake System with Well
- 5430-30154** Captus 4000e Thyroid Uptake and Well Counting System with 2" Well Shielding
- 5430-00007** Captus 4000e DICOM Interface

- Related:**
- 5230-0038** Neck Phantom
  - 5420-2164** Well Detector 2" Shield
  - 7315-1850** Rod Source Holder



## Thyroid Uptake Systems

### Cap-DICOM™ Software Compatibility for the Captus 4000e System

*Gain the advantage of DICOM connectivity*

With Cap-DICOM software, the Capintec Captus 4000e system gains the advantage of DICOM connectivity. Cap-DICOM software adds DICOM Modality Worklist (MWL) and DICOM export to the Captus 4000e system. This solution allows patient information and demographics to be pulled from the Radiology Information System (RIS) or Hospital Information System (HIS), thus, reducing errors and time associated with the manual input of patient information.

Cap-DICOM software creates a DICOM secondary capture image from information generated during the uptake procedure. The software exports the DICOM image files to a destination DICOM C-Store provider specified by the user. This destination may be a nuclear medicine workstation or PACS (Picture Archive and Communication System).

#### Features:

- Integrates the Captus 4000e system into a DICOM Radiology Information System and PACS environment
- Supports multiple vendors for nuclear medicine workstations, RIS and PACS systems
- Increases department efficiency and workflow
- Reduces errors associated with the manual input of patient information
- Increases accuracy of patient information in the PACS environment
- Merged uptake reports with thyroid scans can be displayed as a DICOM image
- Improved physician efficiency in interpretation and clinical review of the combined thyroid uptake report and imaging procedure
- Configurable options integrate nuclear medicine into the RIS and PACS environment
- Ability to query the worklist provider by accession number, patient ID, patient name or date
- Intuitive, easy-to-read user interface to quickly sort and search the worklist
- Ability to correct patient information before exporting
- Ability to review final reports before exporting to a nuclear medicine workstation or PACS
- Current Captus 4000e users can upgrade to Cap-DICOM capabilities
- Cap-DICOM options queries the HIS/RIS for the DICOM Modality Worklist and places patient demographics in the Captus 4000e database, eliminating the need to manually enter patient information

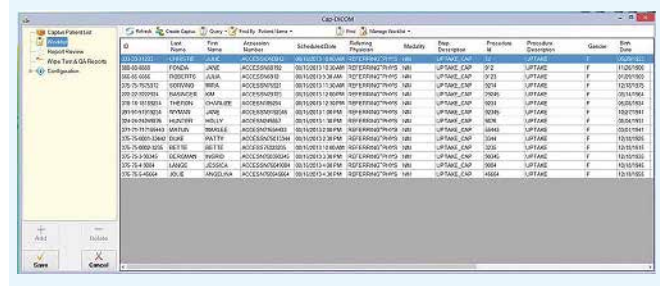

#### DICOM Conformance

- C-Store User
- C-Store Provider
- Modality Worklist User



5430-0007 Cap-DICOM® Software – Captus® 4000e

## Thyroid Uptake Systems



### Wipe Spot Pads

*Soft, highly absorbent cotton pads*

Ultra-absorbent Wipe Spot Pads easily absorb any removable contamination for wipe testing. These wipe pads are backed by a card with space for indicating the wipe location, date and time, activity found, and the initials of the user. These soft, highly absorbent cotton pads may be used either wet or dry to discover contamination.

The Wipe Spot Pads are packed 500 to a box. The adhesive backing allows the wipe to be folded back upon itself and inserted into a test tube for counting.



### Captus Neck Phantom

*Designed to represent a patient's neck*

The Captus neck phantom is made of clear Lucite designed to represent a patient's neck. The phantom has a two part insert that allows counting in a bottle or vial, as well as capsule counting. The unit is etched to show where the caliper of the thyroid probe should be placed for proper alignment. The phantom allows for placement in a vertical or horizontal position. This phantom meets all suggested requirements for use in counting a thyroid uptake standard source.

**5420-0086** Wipes, 500/box  
**006-350** Wipe Test Kits, 1.75" dia., 500/pkg  
**006-352** Wipe Test Kits, .5" dia., 500/pkg

**5230-0038** Captus Neck Phantom



## Thyroid Uptake Systems



### Counting Test Tubes

Popular size 12 x 75 mm test tubes are available boxed and oriented in one direction for ease of use. The re-closable box minimizes scratches and damage during storage and protects the unused tubes. Box contains 250 tubes.



### Rod Source Holder

*Available boxed and oriented in one direction for ease of use*

Designed to provide precise, reproducible positioning of check sources in the thyroid uptake collimator. Easy to clean, and break resistant.



### Captus Well Liner

The well liner is made of a very thin plastic that is used with the Drilled Well Crystal.

0670-0016 Counting Tubes, 250/box

7315-1850 Rod Source Holder

5120-0176 Captus Well Liner 5/pkg

# Syringe Shields

## Expertly Designed for Safer Handling

To significantly reduce hand exposure from radiopharmaceuticals during injections, tungsten and lead glass Syringe Shields are engineered for optimal protection and convenience.

- Tungsten Syringe Shields
- Lead Glass Syringe Shields
- PET Syringe Shields
- Beta Syringe Shields
- Carriers and Holders for Safe Handling
- Injection and Disposal Supplies



**CAPINTEC**  
A MIRION MEDICAL COMPANY

## DELIVERY, DETECTION AND DIAGNOSIS

# Well Counters & Radio-TLC

## CAPRAC-t Wipe Test/Well Counter

No need to worry about meeting the regulations in 10 CFR Part 35.315 (200 dpm requirements for unrestricted areas and iodine contamination). The Capintec CAPRAC-t Wipe-Test Counter handles all of them.

Measure for measure, no other well counter offers the speed, accuracy and complete range of built-in features provided by the compact CAPRAC-t counter. It performs a wipe test in just six seconds (for 1 nCi) and detects extremely low levels of activity with the accuracy only a NaI drilled-well detector can provide.

The CAPRAC-t system can also serve as a single-well gamma counter in departments that do not need multi-sample changers. User-defined protocols, trigger levels, and counting times are a "snap". A 256-channel pulse-height analyzer permits built-in gamma spectroscopy. Definable conversion factors for specific radionuclides allow the CAPRAC-t counter to calculate results in cpm, dpm, nCi, cps, dps, or kBq. The CAPRAC-t unit also displays full spectrum.

The CAPRAC-t counter is engineered and built for years of consistent, reliable performance and is curie or becquerel selectable. The unit has automatic background subtraction and self-diagnosis programs for systems testing with optimized signal-to-noise ratio. It includes a lead outer shield (1.3 cm thick) with optional auxiliary shield available.



### Features:

- 8" SVGA touch screen color display
- 256 channel MCA with detailed spectrum for identification analysis
- NaI drilled-well crystal detector
- Automatic energy calibration, constancy check, and background subtraction
- Automated well QC including chi-square and MDA
- Manual and Automatic ROI
- Sets user-definable protocols for wipes
- Printouts of all data for permanent records with the optional printer
- Direct readouts with spectrum display are in cpm, dpm, curies and becquerels
- Meets all state and NRC wipe test requirements
- USB and RS-232 communication ports for PC and printer
- Compatible with nuclear medicine information management systems via USB
- Built-in database for test and wipe results as well as QC

## Well Counters &amp; Radio-TLC

**Specifications:****PHYSICAL:****Console Dimensions**

- 9.5" h x 9" w x 10.5" l (42 x 23 x 27 cm)
- Weight: 7.5 lb (3.4 kg)

**Well Counter Dimensions**

- 9.38" h x 6" dia. (23.8 x 15.2 cm)
- Weight: 15.2 lb (6.9 kg)
- Well Diameter: .67" (1.7 cm)
- Well Depth: 1.5" (3.8 cm)
- Cable Length: 2.7 m (9 ft)

**Cables**

- Power: 6 ft (1.8 m)
- Printer\*: 6 ft (1.8 m)

**Performance**

- Type: Drilled-well crystal, NaI(Tl) scintillator
- Crystal Dimensions: 1.5" x 1.75" (3.8 x 4.4 cm)
- Shielding: 0.5" lead (1.3 cm)
- Shielding: 9 ft (2.75 m) interconnecting cable
- Channels: 256
- Counting Rate: 100,000 cps, max

**Well Detector**

- Type: 1 1/2" Sodium Iodide (NaI) drilled-well crystal detector
- 256 Channel MCA, manual and automatic ROI
- Trigger Levels: User-definable
- Automated Calibration and Background Subtract
- QC Tests: Reproducibility, Chi-square, MDA

**Display Screen**

- Type: 8" VGA LCD color touch screen display
- Bq/Ci Reading: User selectable or fixed
- Activity Display: Selected radionuclide, efficiency, measured activity and display units (Bq/Ci)
- Count Rate Values: Wipe results

**Standard Source Data**

- System Memory: Cs-137, Eu-152
- Efficiency for commonly used isotopes

**PC Port**

- Interface: RS-232 and USB
- Compatibility: Standard nuclear medicine management systems

**Printer**

- RS-232 and USB Ports

**Power Requirement**

- 100-240 VAC (50/60 Hz) 25 W



5430-0058 Epson Roll Printer

**Tests**

- Diagnostics: Full test of program, system memories

**Cable**

- Printer (Optional): 6 ft (1.8 m)
- Power: 6 ft (1.8 m)

\*Longer cables are available. Consult factory.



**5430-3136** CAPRAC-t Wipe Test/Well Counter

**Related:**

- 0975-137R** Cs-137 Rod Source
- 0975-152R** Eu-152 Rod Source
- 7900-0352** Protective Screen Covers
- 5430-0058** Epson Roll Printer
- 5420-2141** PET Auxiliary Shield
- 0670-0016** Test Tubes for Samples (250/package)
- 9282-0009** Roll Paper
- 5420-0121** Well Liners

## Well Counters & Radio-TLC

### CAP-TLC™ Scanner

#### Automated TLC strip QC scanner

The Capintec CAP-TLC Scanner is an automated quality assurance tool to rapidly and accurately perform strip QC for any SPECT radiopharmaceutical kit. Dual detector design assures a wide activity range for kits reconstituted any time of the day. The scanner has an optional feeder attachment which holds up to 30 samples. Short scan times assure rapid processing.

The system is compatible with most nuclear pharmacy management systems. Report includes activity distribution graph and Pass/Fail results based on user defined acceptance limits. Automated transfer of data eliminates manual record keeping.

#### Optional Features

- Bar Code Reader
- Multi Cartridge Feeder
- Collection Tray

#### Features:

##### Software

- Windows 10 based application software
- Multiple password security levels
- Manual or bar code assisted job creation
- Daily QC test module
- User definable scan protocols
- Define scan by total counts or time
- Automatically rescans to achieve total counts
- User definable Pass/Fail limits
- Failed results printed in RED
- Includes one strip and two strip protocols
- Supports two or three user defined cut points
- Automatic background subtract
- Excel Report format for easy export
- PC Communication Protocol
- Compatible with most printers

##### Hardware

- Two collimated GM detectors
- Scanning range 4  $\mu$ Ci – 2 mCi
- Scan times typically 1-2 minutes
- Single axis step motor
- Adjustable step points
- Includes QC cartridge
- Custom strip holder cartridge
- Maximum strip length 11.5 cm
- Maximum strip width 2 cm
- Hinged cover provides easy access for cleaning
- USB interface



#### Specifications:

- Minimum Display Resolution: 1280 x 720 (720 p)
- CPU: x64 processor, 2 GHz or faster
- Operating System: Windows 10
- Minimum Memory: 4 GB
- Minimum Hard Drive: 40 GB
- Microsoft Office or LibreOffice
- Console Dimensions 6.7" h x 8.1" w x 9.6" l (17 x 20.5 x 24 cm)
- Weight: 21.6 lb (9.8 kg)
- Feeder Dimensions: 9.9" h x 5.1" w x 12.1" l (25.1 x 12.9 x 30 cm)
- Weight: 9.0 lb (4.1 kg)
- Working Environment: 0 to 60 °C, 0 to 90% humidity, non-condensing
- Power Requirements: 110-240 VAC 50/60 Hz 50 W



**5250-0212** CAP-TLC Scanner  
Includes: Console, one QC cartridge and three strip cartridges.

#### Related:

**5250-0213** Auto Feeder  
**5250-0214** Cartridges 10/pkg  
**5250-0215** Bar Code Scanner  
**5250-2110** Collection Tray  
**0975-0137** Co-57 100  $\mu$ Ci QC Source

## Well Counters &amp; Radio-TLC

**PET Auxiliary Shield**

*PET auxiliary shield for the 55tW and CAPRAC-t counter*

The Well Auxiliary Shield is made with 1.5" thickness for shielding and sits on its own supporting base. The shield fits snugly around the well chamber for a total of 2" and can be easily installed or removed, as needed.

**Specifications:**

- Dimensions: 15.625" h x 7.5" w x 6.75" d (39.6 x 19 x 17 cm)
- Weight: 90 lb (40.8 kg)

**5420-2141** PET Auxiliary Shield

**CAPRAC PET Auxiliary Shield**

The CAPRAC PET Auxiliary Shield allows for greater shielding of the NaI crystal when higher energy isotopes are being used. This is accomplished by shielding which is 1" thick on the top and walls. The shield fits snugly around the well chamber and can be easily installed or removed.

**Specifications:**

- Dimensions: 16.625" h x 6.75" w x 8.75" d (42.2 x 17.1 x 22.2 cm)
- Weight: 91 lb (41.2 kg)

**5420-2137** CAPRAC PET Auxiliary Shield

**CAPRAC Well Liner**

The well liner is made of a very thin plastic that is used with the CAPRAC-t Wipe Test/Well Counter.

**5420-0121** CAPRAC Well Liner, 5/pkg

## Well Counters & Radio-TLC



### CAPRAC Test Tube

Test tubes are available boxed and oriented in one direction for ease of use. The re-closable box minimizes scratches and damage during storage and protects the unused tubes. Box contains 250 tubes.

**Specifications:**

- Dimensions: .625" dia. x 2.5" l (1.5 x 6.3 cm)



### CAPRAC Test Tube

*Protects against contamination*

Test Tube for CAPRAC-T, CRC-25W, CRC-55tW, CAPRAC, CAPRAC-R products. Disposable Plastic Test Tubes.

**Features:**

- Disposable Plastic Test tubes
- Fits Neatly Into Liner

**Specifications:**

- Dimensions: .626" dia. x 2.5" l (1.5 x 6.3 cm)

**0670-0016** CAPRAC Test Tube, 250/box

**5420-0087** Disposable Test Tube, 100/pkg  
*Accommodates disposable plastic test tubes with flat bottoms.*



# Lung Ventilation

## Superior Lung Imaging

- Pulmonex® II Xenon System
- Xenon Trap Monitor
- Xenon Disposables
- Xenon Convenience Kits
- Xenon Dispenser
  
- Venti-Scan™ IV Radioaerosol System
- Radioaerosol Convenience Kits
- AeroTech™ I Radioaerosol System



DELIVERY, DETECTION AND DIAGNOSIS

# Lung Ventilation Systems & Accessories

## Venti-Scan™ IV

The Venti-Scan IV Radioaerosol Administration System is a self-contained single-use delivery system for Technetium DTPA

### Sharp, Clear Images - Easy Breathing

The Venti-Scan IV Radioaerosol Delivery System features a small baffle within the nebulizer to produce an optimal particle size, resulting in a sharp image, quickly. In addition, the kit includes a contoured filter for trapping moisture. This makes it ideal for radioaerosol studies by impeding humidified radiation from passing through. The filter's contour increases surface area to decrease breathing resistance, making it virtually resistance-free with exceptional trapping efficiency.

### Designed For Efficiency

The Venti-Scan IV is designed to make performing a study more convenient for the technologist while providing superior images. When the kit is inserted into the Venti-Scan IV canister it automatically locks securely into position, assuring all port alignments. Oxygen connection is a simple attachment to a dedicated external port. The injection site on the kit is precisely angled to align with the canister port. They are positioned perfectly for a bullseye every time. The system also offers a quick, safe disposal method. Unplug the oxygen hose, invert the canister over a shielded waste container and push the release button to free the contaminated kit. This minimizes handling and exposure.

### Full Technologist Protection

The Venti-Scan IV shield is completely enclosed providing lead-shielded protection from top to bottom. The Venti-Scan IV Disposable Kit includes everything needed for a single study including a comfortable, natural contour mouthpiece, filter, nose clip and disposal bag. The system uses clean-bore straight path tubing (superior to corrugated) to ensure that particles cannot get trapped in any internal ridges that typically cause clumping. The top of the canister has a shielded sliding port to accommodate the Venti-Pak Accessory Kit for ventilator-assisted patients. An IV pole mount is included with the shield for convenient positioning and administration.

### Simple Steps to Perform a Study

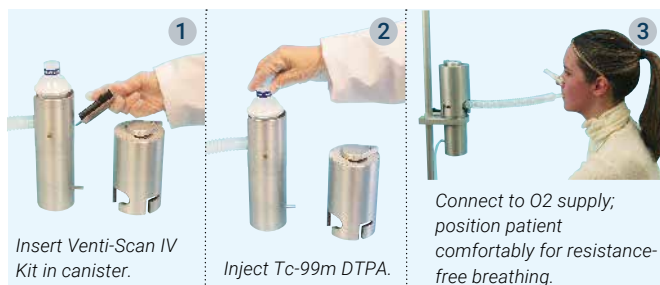

Patients and technologists have always been comfortable and confident with the Venti-Scan system. And, when the patient is comfortable, the procedure goes smoothly, without interruption. The end result is a superior study.

### Features:

- System design reduces setup time:
  - Kit automatically locks into position
  - One step oxygen connection to dedicated external port
  - Precise injection port alignment
  - Push button disposal of used kit
- Fully enclosed lead shielding from top to bottom
- Contoured filter for increased trapping efficiency and resistance-free breathing
- Trapping efficiency greater than 99.9%
- Small baffle design ensures homogeneous distribution
- Mean particle size = 0.50 microns
- Lightweight and portable, weighs only 8 lb (3.7 kg)

**177-090** Venti-Scan IV  
Includes: Shielded canister with IV pole mount

### Radioaerosol Convenience Kits™

**177-091** Convenience Kit, Venti-Scan IV ®  
Includes: 12" (30.5 cm) tubing, small particle delivery system with mouthpiece, filter, nose clip and disposal bag



**177-092** Convenience Kit, Venti-Scan IV ®  
Includes: 24" (61 cm) tubing, small particle delivery system with mouthpiece, filter, nose clip and disposal bag



Note: Each kit is sold in multiples of 10 and 25.

### Related:

**177-075** Convenience Kit, Venti-Pak for Venti-Scan IV (adapter kit for ventilator assisted patients)®  
Note: Each kit is sold in multiples of 5.

® Denotes Single Use Only

## Lung Ventilation Systems & Accessories

### Aerotech™ I Radioaerosol Administration System

*The original Cadema Radioaerosol System*

Aerosol inhalation for radioimaging studies is an important tool for use in the localization and diagnosis of lung disease. AeroTech I puts information in the hands of the user to assist in diagnosis of a variety of lung diseases.

#### Enhanced Imaging

The AeroTech I delivers an even distribution of radioaerosol throughout the lungs, reaching the respiratory bronchioles and alveolar ducts and sacs. Excellent aerosol deposition allows the acquisition of multiple views from each diagnostic study. The end result is high quality imaging for confidence in patient diagnosis.

#### Respirator Compatible

For patients on a respirator, AeroTech I is easily adapted to fit on line using a single accessory tube.

#### Designed for Patient Comfort

Aerosol inhalation studies allow the patient to breathe normally throughout the procedure, minimizing the likelihood of patient non-compliance.

#### Superior Safety

Shield construction, disposable components and rapid aerosol delivery time combine to minimize radiation exposure to the patient and technologist. AeroTech I helps meet ALARA radiation protection objectives.

#### Flexibility

AeroTech I is available with a choice of designs. The 177-324 Delivery System generates a smaller MMAD particle than the standard 177-124 Delivery System. Use the 177-324 model for procedures where delivery time is not significantly restricted.

#### Features:

- Enhanced Imaging
- Multiple views from one diagnostic study
- Completely portable and respirator compatible
- Completely Shielded

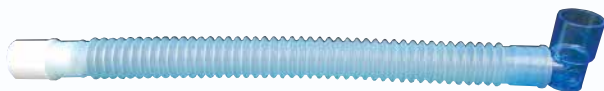

177-325 Venti-Pak for ventilator assisted patients



Shown with kit# 177-124, sold separately.

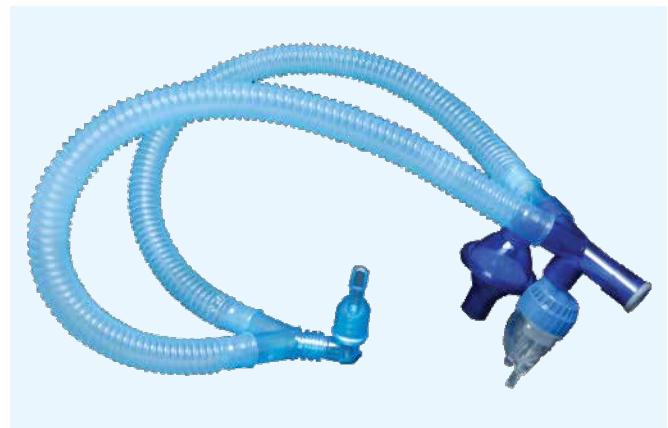

**177-095** AeroTech I Shield

#### Radioaerosol Convenience Kits™

**177-124** Convenience Kit, AeroTech I ☉  
Includes 24" (61 cm) tubing, standard nebulizer delivery system with mouthpiece, bacteria filter, nose clip and disposal bag

LATEX FREE

**177-324** Convenience Kit, AeroTech I with small particle delivery system ☉  
Includes 24" (61 cm) tubing, small particle nebulizer delivery system with mouthpiece, bacteria filter, nose clip and disposal bag

LATEX FREE

Note: Each kit is sold in multiples of 5.

#### Related:

**177-325** Convenience Kit, Venti-Pak for AeroTech I, 5/pkg ☉ (adapter kit for ventilator assisted patients)

## Lung Ventilation Systems & Accessories

### Pulmonex® II Xenon System

The Pulmonex II Xenon System is the best choice for the safe performance of all regional ventilation studies. This is a completely closed system that delivers maximum, reliable results, is simple to operate and reasonably priced.

#### Resistance-Free Breathing

The injected bolus of xenon will reach the patient exactly when desired. Oxygen may be added to the system any time during the study with the press of a button. An in-line cartridge containing Litholyme absorbs CO<sub>2</sub>, preventing acidosis. Large breathing passages, two 10-liter breathing bags (air-in and air-out) and motor-assisted airflow combine to provide resistance-free breathing.

#### Simple to Operate

All three steps of a Pulmonex II study (start up, equilibrium imaging and washout) are controlled by a single valve handle on the front panel. The valve directs the motor-assisted flow of gases throughout the system. A manually adjusted 15-minute timer initiates all functions, then automatically shuts down the system to complete the study after patient and system washout. With controls conveniently located on the front panel, the user can operate the system and observe the patient and gamma camera from one position. Panel controls are clearly marked for each mode of the procedure with large viewing windows to make it easy to monitor the patient's breathing. The trim, clean design, large handles and total mobility permit easy positioning of the system for studies in both seated and supine positions.

#### Designed for Safety

Internal systems of the Pulmonex II are shielded for patient and operator safety. The system features two built-in gas traps that operate with a blower fan. Exhaled xenon is pulled through activated charcoal housed within two .125" lead shielded "U"-shaped traps. The double traps extend the life of your charcoal and provide a lengthy migration path for xenon effluent, allowing greater decay and absorption before exhaustion. A cartridge containing Drierite serves as a moisture absorber for air passing into the trap. The charcoal trap can then more effectively remove xenon effluent after each study. Airflow regulation of the trap blowers assure complete patient and system washout. Averaging 30-50 studies per month, the charcoal trap will last approximately one year; charcoal traps are easily replaced. A disposable bacteriostatic filter, used in conjunction with a disposable mask or mouthpiece, prevents system contamination.

#### Features:

- Resistance-free breathing with 25-liter capacity
- Complete .125" lead shielding in upper cabinet for patient and operator safety
- Easy access to replace Drierite and Litholyme cartridges
- Effortless mobility for easy patient positioning
- Stylish steel cabinet
- Convenient built-in stainless steel tray for holding disposables, xenon gun, syringe, etc.



#### Specifications:

- Dimensions: 20.5" w x 22" depth x 48.5" h (52.1 x 55.9 x 123.2 cm)
- Motor: UL approved. 12 volt DC
- Electrical Requirements: 115 VAC, 1 amp, 50/60 Hz
- Casters: locking
- Shipping Weight: 375 lb (172.5 kg)
- Certifications: See website for details
- Warranty: One year parts and labor



**132-503** Xenon System, Pulmonex II, Double-Trap, 115 VAC  
Includes sampling of xenon products.  
**Currently not for sale in the USA**

**Related:**  
**136-755** Xenon Trap Monitor  
**150-315** Dispenser, Xenon, Automatic  
**130-900** Pulmonex Kit, Free Breathing Hose  
**132-504** Protective Cover, Pulmonex II

**Replacement:**  
**132-319** Charcoal Trap, Pulmonex II  
**132-555** Cartridge, Refillable, Litholyme or Drierite



## Lung Ventilation Systems & Accessories



### Automatic Xenon Dispenser

*Assures quick, accurate and easy delivery of xenon directly to the patient*

The Automatic Xenon Dispenser is easily attached to the front of the Pulmonex System without the use of tools. Preload the xenon vial into the supplied plunger. At the precise moment you want the xenon delivered to the patient, simply press the dispense button.



### Xenon Trap Monitor

The Xenon Trap Monitor continuously monitors trap effluent during a xenon study, meeting compliance requirements in most states. An exhaust hose connects from the Pulmonex II exhaust port to the Xenon Trap Monitor's intake port. Counting results are displayed with both audible and visual signals to indicate when the xenon trap exhaust port exceeds of 99 pCi/mL. The unit can also check background levels and perform a self-test for proper operation using a check source. A 10  $\mu$ Ci Cs-137 check source is required to calibrate the monitor.

#### Specifications:

- Dimensions: 7" l x 6" w x 4" h (17.8 x 15.2 x 10.2 cm)
- Lead Shielding: .5" thick (1.3 cm)
- Input: 22 mm Hose Adapter
- Detector: Halogen Quenched GM Tube, 1.1 cm dia., 2 mg/cm<sup>2</sup> mica window
- Voltage: 500 volts regulated
- Buttons: On/Off, Next/Mute
- Display: 4 Digit LED, 4 RGB Function LEDs (Self Test, Background, Check Source or Count)
- Readings: pCi/ml or counts
- Speaker: Internal, beeps in alarm mode
- Background Count Time: 1 minute
- Power: 18 volts, UL approved, external; 115 VAC power adapter
- Weight: 5.25 lb (11.55 kg)
- Warranty: One year

**150-315** Dispenser, Xenon, Automatic  
Includes 72" Flexible Tubing with Luer-Lock Adapter

**Replacement:**  
**150-317** Tubing, 72" Luer-Lock Adapter, 5/pk

**136-755** Monitor, Xenon Trap  
Mounts to Pulmonex II Xenon Systems

**Related:**  
**101-103** Check Source, Cs-137, 10  $\mu$ Ci  
Uncalibrated, 1" dia. x .25" thick (2.5 x 64 cm)

# Xenon Convenience Kits™

- Air-Cushioned Face Mask Kits with clear ultra-flex expandable tubing from 6" to 24"
- Mouthpiece Kits with Direct Dose Administration adapter for leak-proof Xenon delivery

Xenon Convenience Kits bring together all the components needed to complete a single xenon study. Xenon can be administered via Direct Dose Administration, that conveniently luer locks without the use of a needle; or by injection port, which requires a syringe needle. Easy to use, simple to order and disposable, Xenon Convenience Kits are an investment in time-savings. Plus, our complete kits can prolong the life of your xenon charcoal traps by ensuring that pre-filled Drierite cartridges are fresh for every scan while the pre-filled Litholyne (CO<sub>2</sub> absorber) cartridges eliminate possible breakdown of granules that can lead to a clogged system and hinder patient air flow.

**For more information, call +1-201-825-9500 or email [capintec@mirion.com](mailto:capintec@mirion.com).**



## Lung Ventilation Systems & Accessories



**Xenon Convenience Kits  
Air-Cushioned Face Mask**



**Xenon Convenience Kits  
Air-Cushioned Face Mask  
with Injection Port**



**Xenon Convenience Kits  
Air-Cushioned Face Mask  
with Luer-Lock Injection Port**

- 132-680** Convenience Kit, Face Mask ☉  
*Includes: Bacteria filter*
- 132-681** Convenience Kit, Face Mask ☉  
*Includes: Bacteria filter and ultra-flex tubing (shown)*
- 132-781** Convenience Kit, Face Mask ☉  
*Includes: Bacteria filter, ultra-flex tubing, Drierite & Litholyme cartridges*  
*Note: Each kit is sold in multiples of 25.*

- 132-690** Convenience Kit, Face Mask with Injection Port ☉  
*Includes: Bacteria filter (shown)*
- 132-691** Convenience Kit, Face Mask with Injection Port ☉  
*Includes: Bacteria filter and ultra-flex tubing*
- 132-784** Convenience Kit, Face Mask with Injection Port ☉  
*Includes: Bacteria filter, ultra-flex tubing, Drierite & Litholyme cartridges*  
*Note: Each kit is sold in multiples of 25.*

- 132-684** Convenience Kit, Face Mask with Luer-Lock Injection Port ☉  
*Includes: Bacteria filter, ultra-flex tubing and 90° luer-lock injection port*  
*Note: Each kit is sold in multiples of 25.*

☉ Denotes Single Use Only

## Lung Ventilation Systems & Accessories



### Xenon Convenience Kits Air-Cushioned Face Mask w/Direct Dose Administration

*No needle necessary*



### Xenon Convenience Kits with Mouthpiece and Direct Dose Administration Adapter

*No needle necessary*

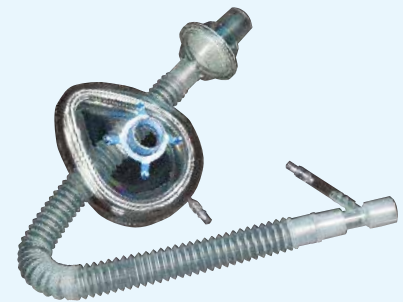

### Xenon Convenience Kits Air-Cushioned Face Mask and Direct Dose Administration Adapter

*No needle necessary*

- 132-699** Convenience Kit, Face Mask with Direct Dose ☉  
*Includes: Bacteria filter*
- 132-692** Convenience Kit, Face Mask with Direct Dose ☉  
*Includes: Bacteria filter and ultra-flex tubing*
- 132-793** Convenience Kit, Face Mask with Direct Dose ☉  
*Includes: Bacteria filter, ultra-flex tubing, Drierite & Litholyme cartridges*  
*Note: Each kit is sold in multiples of 25.*

- 132-770** Convenience Kit, Mouthpiece ☉  
*Includes: Bacteria filter and nose clip*
- 132-774** Convenience Kit, Mouthpiece and Administration Adapter ☉  
*Includes: Bacteria filter, nose clip and ultra-flex tubing (shown)*
- 132-771** Convenience Kit, Mouthpiece and Administration Adapter ☉  
*Includes: Bacteria filter, nose clip, ultra-flex tubing, Drierite & Litholyme cartridges*  
*Note: Each kit is sold in multiples of 25.*

- 134-772** Convenience Kit, Face Mask and Administration Adapter ☉  
*Includes: Bacteria filter and ultra-flex tubing*  
*Note: Each kit is sold in multiples of 25.*

## Lung Ventilation Systems & Accessories



### Air-Cushioned Face Mask

The air-cushioned face mask has a pre-filled air-cushion (medium inflation pressure) that molds to the contour of the patient's face providing a tight, leak-proof and comfortable seal. Cushion pressure is easily adjusted by inserting a standard syringe without needle in the two-way valve located on the mask bottom. The flexibility of cushion pressure allows optimum surface contact for every patient. Transparency of the entire mask allows continuous visual identification of patient's vital signs.

**132-685** Face Mask without Injection Port, Adult ☉  
 Note: Each kit is sold in multiples of 25.



### Air-Cushioned Face Mask with Direct Dose Administration

*No needle necessary*

In addition to the patient comfort provided by the soft, pliable air cushion of the disposable face mask, the direct dose feature reduces patient anxiety because no needle is used. The syringe luer locks tightly to the direct dose tube, away from the patient's face. The one-way valve prevents the gas from reversing through the mask luer connector, allowing the technologist to disconnect immediately after injecting.

**132-698** Face Mask with Direct Dose Administration, Adult ☉  
 Note: Each kit is sold in multiples of 25.

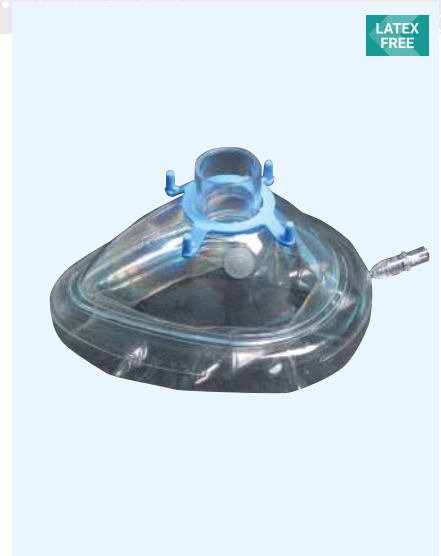

### Air-Cushioned Face Mask with Injection Port

The air-cushioned face mask has a pre-filled air-cushion (medium inflation pressure) that molds to the contour of the patient's face providing a tight, leak-proof and comfortable seal. Cushion pressure is easily adjusted by inserting a standard syringe without needle in the two-way valve located on the mask bottom. The flexibility of cushion pressure allows optimum surface contact for every patient. Transparency of the entire mask allows continuous visual identification of the patient's vital signs. The injection port is attached directly to the face mask and requires a syringe with a needle.

**132-695** Face Mask with Injection Port, Adult ☉  
 Note: Each kit is sold in multiples of 25.

## Lung Ventilation Systems & Accessories



LATEX FREE

### Face Mask Harness

This traditional Face Mask Harness is made of soft rubber and can be adjusted for any head size. The square rubber base is comfortably positioned on the back of the patient's head and the harness tails are brought around to the front. The small holes provide a snug fit on the hook ring, holding the mask firmly in place.

139-677 Face Mask Harness



LATEX FREE

### Disposable Nose Clip

Economical, this nose clamp is all plastic for single patient use. Used with any mouthpiece.

130-100 Nose Clip, Disposable,  
100/pkg ☉



LATEX FREE

### Disposable Bacteria/Viral Filter

Bacteria filters are used to reduce the possibility of cross contamination. The single-use filter is placed in line between a delivery tube and disposable mouthpiece or face mask. Electrostatically charged filter media is 99.9% effective in bacteria/virus retention while maintaining low breathing resistance. Two filters can be piggy-backed together for potential high-risk studies.

132-750 Bacterial/Viral Filter ☉  
*Note: Each kit is sold in multiples of 25.*

☉ Denotes Single Use Only

## Lung Ventilation Systems & Accessories

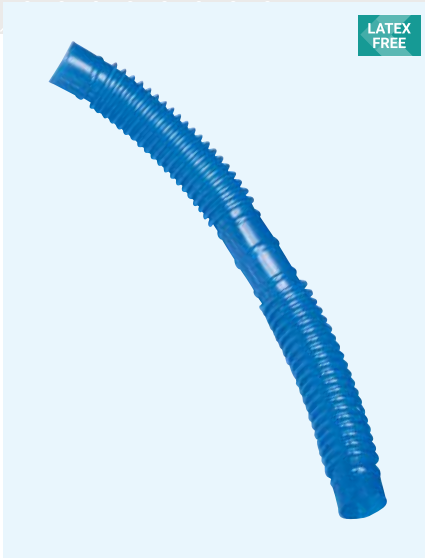

### Corrugated Tubing

Corrugated Tubing is scored and capped at 6" intervals for easy cutting and firm attachment to fittings.



### Tubing Splice

Tubing Splice is used to connect sections of 22 mm corrugated tubing to individual mask and filter.



### "Y" Connector

The "Y" Connector has a one-way valve and plug. It is used to connect two 22 mm tubes to a mouthpiece, face mask or bacteria filter.

**139-680** Tubing, Corrugated,  
100 ft/roll ☒

**130-639** Tubing Splice,  
22 mm Male, 10/pkg ☒

**185-302** "Y" Connector, luer plug ☒  
**139-102** "Y" Connector, solid plug ☒  
*Note: Not for use with the Pulmonex II*

## Lung Ventilation Systems & Accessories



### Drierite

*Moisture absorber - blue and white blend*

Drierite serves as a moisture trap for the air going into the charcoal trap of the Pulmonex Xenon System. Drierite is blue and white when dry and turns pink when it has absorbed maximum moisture. Available in two convenient sizes, Drierite is packaged in an air-tight container with a wide-access mouth.



### Litholyme

*CO<sub>2</sub> absorber*

Litholyme, a highly efficient CO<sub>2</sub> absorber, prevents patients from re-breathing carbon dioxide and subsequent acidosis. Available in two convenient sizes, Litholyme is packaged in an air-tight container with a wide-access mouth.

- 139-101** Drierite, 1 lb
- 139-104** Drierite, 4.5 lb
- 132-772** Drierite, Disposable Cartridge <sup>Ⓢ</sup>

- 130-019** Litholyme, 1 lb
- 130-020** Litholyme, 4.5 lb
- 132-773** Litholyme, Disposable Cartridge <sup>Ⓢ</sup>



## Lung Ventilation Systems & Accessories



### Free-Breathing Pulmonex Hose Kit

*When unrestricted breathing is critical*

The Free-Breathing Pulmonex Hose Kit features large bore tubing, which allows for minimal breathing resistance. This inexpensive, high quality, "free breathing" hose kit includes all required components and adapters.

The kit contains two 130-901 "Clean-Bore" hoses (36" l x 1 1/8" dia.), two 130-904 hose clamps, and a 130-902 non-rebreathing anesthesia valve (inlet and outlet 7/8" O.D.), which permits the use of standard disposable bacteria filters and masks while providing unrestricted airway.



*Shown with Air-Cushioned Face Mask with Direct Dose Administration.*

### Xenon-133 Rebreathing Systems

*Disposable pre-packaged kits*

A simple, safe and inexpensive method of administering Xenon-133 to perform perfusion steady state and wash out studies. Each kit comes as a complete disposable system, including a pre-filled Litholyme absorber cartridge and a 35-liter bag to ample volume for patient maintenance and collection of expired Xenon-133. Made of a non-permeable plastic, the disposable system precludes xenon absorption or transfer through the device's components. The system is designed to accept any xenon syringe/gun administration system. The entire rebreathing system is disposed of in accordance with NRC regulations.

**130-900** Pulmonex Kit, Free-Breathing Hose

**Replacement:**

- 130-901** Hose, "Clean-Bore"  
36" l x 1.125" dia. (91.4 x 2.9 cm)
- 130-902** Valve, Anesthesia  
Hans Rudolph, non-rebreathing
- 130-903** Adapter, Hose  
.875" x 1.125" dia. (2.2 x 2.9 cm)
- 130-904** Clamp, Hose

- 060-133** Xenon-133 Rebreathing System, Mouthpiece ©  
Kit includes: Mouthpiece (130-551)
- 060-137** Xenon-133 Rebreathing System, Mask ©  
Kit includes: Air-Cushioned Face Mask with Direct Dose Administration (132-698)

*Note: Each kit is sold in multiples of 5.*

© Denotes Single Use Only

DELIVERY, DETECTION AND DIAGNOSIS

# Positioning Devices

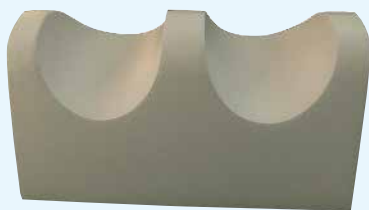

## Leg Rest

Contoured Leg Rests come in three sizes. These unique leg rests help with comfort and support which minimizes body motion.

**Specifications:**

0652-0037 Small Leg Support

- Dimensions: 18" w x 14" d x 5" h (45.72 x 35.56 x 12.7 cm)

0652-0040 Medium Leg Support

- Dimensions: 18" w x 17" d x 7" h (45.72 x 43.2 x 17.78 cm)

0652-0041 Large Leg Support

- Dimensions: 24" d x 18" w x 10" h (60.96 x 45.72 x 25.4 cm)

**0652-0040** Medium, Leg Rest  
**0652-0041** Large, Leg Rest

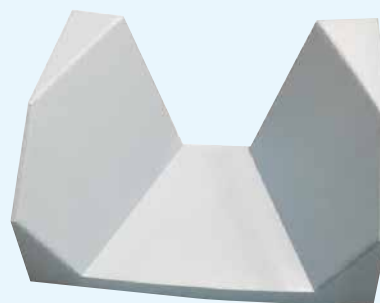

## Patient Arm Support

Head/Arm Supports are designed to safely fit the multi-head imaging and diagnostic cameras. They can accommodate any patients with its soft, yet durable coating. They are easily cleaned.

**Specifications:**

- Dimensions: 9" h x 20" w x 8" d (22.86 x 50.8 x 20.32 cm)

**0652-0038** Patient Arm Support II, Antimic

## Positioning Devices

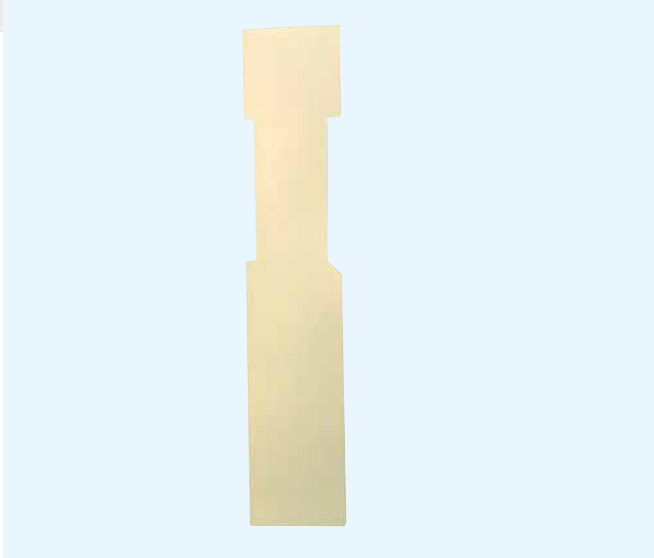

### Cardio MD Table Pads

*Anti-microbial health care covering*

The Cardio MD Table Pads sit on standard hospital bed platforms or patient stretchers. The pull-out section creates space so the technician can manipulate the transducer for optimum visualization.

Replacement Table pads for most cameras.

- Quality replacement Table Pads
- Anti-Microbial health care covering
- Spray on coating
- Custom branding
- Choice of foam
- Custom designs

Color options available:

- Black
- Deep Blue
- Medical Blue
- Light Blue
- Gray

**0652-0043** Cardio MD Table Pad, Long



### Table Pad

We provide table pads to fit all OEM tables.

#### Specifications:

0652-0046 E-Cam Table Pad

- Dimensions: 83" l x 15" w x 1" d (210.8 x 38.1 x 2.5 cm)

0652-0047 Infinia Antimicrobial Table Pad

- Dimensions: 78" l x 14" w x 1" d (198.1 x 35.5 x 2.5 cm)

**0652-0047** Infinia Antimicrobial Table Pad, without strap

LAB SUPPLIES

# Shielding & Storage

SHIELDING & STORAGE



## Pro-Tec™ III Syringe Shield

The Pro-Tec III Syringe Shield is designed to reduce hand exposure in clinicians preparing and administering radiopharmaceuticals. With its lightweight, sleek design, this syringe shield is easy to use.

The barrel of the shield is constructed of 2 mm thick tungsten that will reduce radiation exposure from Tc-99m by more than 99% attenuation for Tc-99 tested with TLD chips. A 5.05 density lead glass window provides protection and optimal visibility. A white reflective surface on the shield interior improves viewing of the syringe's markings and fluid content. Polymer encasement and beveled edge around the lead glass helps guard against scratching or breaking. The quick release, Safe-T-Lock is designed to facilitate minimal handling, thereby reducing hand exposure. Upon insertion, the Safe-T-Lock grips and securely locks the syringe into place. Disposing of used syringes is easy; invert the syringe shield over a sharps container, press the release button and the syringe freely disengages.

**Features:**

- 2 mm thick tungsten shielding
- 5.05 density lead glass window
- Safe-T-Lock firmly secures syringe to avoid rotating
- Safe-T-Lock design reduces exposure with faster handling
- Unobstructed visibility to tip of syringe
- Replacing scratched or broken glass is simple – no gluing required
- Easily sanitized with alcohol wipes

**Pro-Tec III Syringe Shields:**

- 007-723** Syringe Shield, 1 cc (BD luer lock)
- 007-734** Syringe Shield, 1 cc (press fit)
- 007-755** Syringe Shield, 2.5 cc (HSW)
- 007-735** Syringe Shield, 3 cc
- 007-736** Syringe Shield, 5 cc
- 007-738** Syringe Shield, 10 cc

**Replacement:**

- 127-734** Syringe Shield Replacement Glass, 1 cc
- 127-735** Syringe Shield Replacement Glass, 3 cc and 5 cc
- 127-738** Syringe Shield Replacement Glass, 10 cc

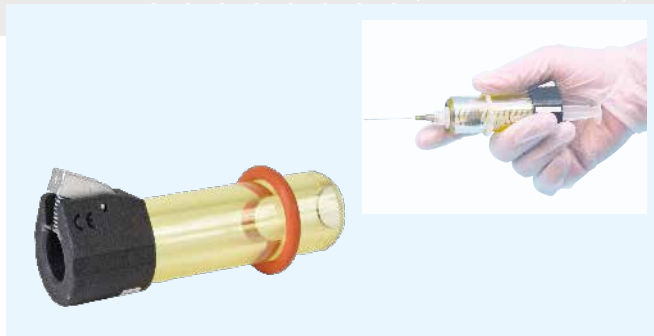

## Pro-Tec™ IV Syringe Shield

Convenient to use, the Pro-Tec IV Syringe Shield reduces hand exposure and maximizes the viewing area.

The barrel of the shield is constructed of optically clear, 5.6 high density lead glass. The 360° view and a tapered end on the lead glass barrel provide complete visibility of the syringe contents, allowing for faster and easier venipuncture. The high density lead glass significantly reduces radiation exposure from Tc-99m by more than 99% attenuation for Tc-99m tested with TLD chips.

The Safe-T-Lock is designed to facilitate minimal handling, reducing hand exposure. Upon insertion, the Safe-T-Lock grips and securely locks the syringe into place. Disposing used syringes is easy; invert the syringe shield over a sharps container, press the release button and the syringe freely disengages.

**Features:**

- 5.6 High density lead glass shielding; 360-degree barrel view
- Lightweight
- Fits most disposable syringes
- Safe-T-Lock design reduces exposure with faster handling
- 5 cc syringe shield – ideal for Quadramet®
- Easily sanitized with alcohol wipes

**Pro-Tec IV Syringe Shields:**

- 007-675** Syringe Shield, 3 cc
- 007-680** Syringe Shield, 5 cc
- 007-685** Syringe Shield, 10 cc

## Shielding &amp; Storage



for  
ZEVALIN™  
for  
BETA

### Beta Syringe Shield

This Beta Syringe Shield reduces hand exposure from syringes containing beta-emitting radiopharmaceuticals such as those used in Theranostics and Therapeutics. The barrel of the syringe shield is constructed of clear plastic, which attenuates Beta emission. The .062" thick embedded lead lining attenuates Gamma emission and errant bremsstrahlung. The viewing window provides clear visibility when drawing and administering a dose. A thumbscrew holds syringes firmly in place.

#### Features:

- Lead and plastic shielding, designed for Beta
- Clear plastic window
- Fits most disposable syringes
- Suitable for alpha emitting therapy agents
- 20 cc syringe shield – ideal for theranostics

#### Specifications:

007-956 Beta Syringe Shield, 1 cc

- Dimensions:  
O.D.: 1.63" dia. x 3.25" l (4.1 x 8.3 cm)  
I.D.: 0.41" dia. (1 cm)
- Shielding: .062" thick (.16 cm) lead
- Weight: 10.4 oz. (297 g)

007-957 Beta Syringe Shield, 10 cc

- Dimensions:  
O.D.: 1.625" dia. x 3.25" l (4.1 x 8.3 cm)  
I.D.: 0.750" dia. (1.9 cm)
- Shielding: .062" thick (.16 cm) lead
- Weight: 9.6 oz (274 g)

007-958 Beta Syringe Shield, 20 cc

- Dimensions:  
O.D.: 1.88" dia. X 3.75" l (4.7 x 9.5 cm)  
I.D.: .96" (2.44 cm)
- Shielding: .062" thick (.16 cm) lead
- Weight: 11.2 oz (318 g)

<b>007-956</b>	Syringe Shield, Beta, 1 cc
<b>007-957</b>	Syringe Shield, Beta, 10 cc
<b>007-958</b>	Syringe Shield, Beta, 20 cc



Dose Drawing Syringe Shield  
(glass non-replaceable)

Dose Drawing Syringe Shield  
with replaceable glass

### Dose Drawing Syringe Shield

*Lightweight, easy-to-use design*

These Syringe Shields reduce hand exposure when drawing doses from a shielded vial. Constructed of optically clear high density lead glass, the barrel of the syringe shield offers complete 360° visibility while reducing radiation exposure from Tc-99m by more than 99%. The shield features quick and smooth syringe insertion with an O-ring seal and anti-roll cap. Constructed with a polymer material on each end that acts as a shock absorber.

#### Dose Drawing Syringe Shields:

*Accommodates luer and non-luer lock syringes*

<b>007-661</b>	Syringe Shield, 3 cc
<b>007-663</b>	Syringe Shield, 5 cc and 6 cc
<b>007-665</b>	Syringe Shield, 10 cc and 12 cc

#### Dose Drawing Syringe Shields with Replaceable Glass:

*Accommodates luer and non-luer lock syringes*

<b>007-691</b>	Syringe Shield, 3 cc
<b>007-693</b>	Syringe Shield, 5 cc and 6 cc
<b>007-695</b>	Syringe Shield, 10 cc and 12 cc

#### Replacement:

<b>127-691</b>	Syringe Shield Replacement Glass, 3 cc
<b>127-693</b>	Syringe Shield Replacement Glass, 5 cc and 6 cc
<b>127-695</b>	Syringe Shield Replacement Glass, 10 cc and 12 cc

## Shielding & Storage



### 511 Dose Drawing Syringe Shield

*Constructed with the same featured shielding as the 511 C-Tec Syringe Shields*

The 511 Dose Drawing Syringe Shields are constructed with the same featured shielding as the 511 C-Tec Syringe Shields. The needle end of the syringe shield has a tungsten disc that protects the user's hands during the dose drawing procedure.

There are 2 pins in the end disc that secure the shield to the Drawing Station. This allows single-handed dose removal from the drawing station. The syringe shield has a tungsten thickness of .315".



### High Density Lead Glass Syringe Shield

The High Density Lead Glass Syringe Shield reduces hand exposure from Tc-99m by more than 99% and allows a large viewing area and is easy to use. The barrel of the syringe shield is constructed of optically clear high density (5.6) lead glass and offers complete 360° visibility. The end of the barrel is tipped with a polymer material to protect it from breaking or scratching. This lightweight shield features quick and smooth syringe insertion with an O-ring seal and an anti-roll cap.

#### Features:

- Lead glass provides clear visibility
- Accommodates most vials
- Centering action holds vials securely

0665-2017 511 Dose Drawing Syringe Shield 5cc

#### High Density Lead Glass Syringe Shields:

*Accommodates luer and non-luer lock syringes*

007-635 Syringe Shield, 3 cc

007-652 Syringe Shield, 5 cc and 6 cc

007-612 Syringe Shield, 10 cc and 12 cc



## Shielding &amp; Storage



### Gaard Lock™ PET Syringe Shield

The Gaard Lock PET Syringe Shield reduces hand exposure from syringes containing 511 keV radionuclides FDG F-18. The syringe shield is offered with a high density (5.6) flush mounted lead glass window that provides protection and visibility. A white reflective surface on the shield interior improves viewing of the syringe's markings and fluid content.

#### Features:

- Unique flange locking design reduces exposure with faster handling
- Constructed of .34" thick tungsten, attenuates FDG F-18 by 88%
- Available with a high density lead glass window
- Easily sanitized with alcohol wipes

#### Specifications:

- Shielding: .34" tungsten (9 mm)
- Lead Glass: 5.6 density

007-716 Gaard Lock Syringe Shield, 3 cc

- Dimensions: 2.9" l (74 mm)
- Weight: 1.7 lb (.77 kg)

007-717 Gaard Lock Syringe Shield, 5 cc

- Dimensions: 3" l (76 mm)
- Weight: 2 lb (.91 kg)

007-718 Gaard Lock Syringe Shield, 10 cc

- Dimensions: 3.6" l (91 mm)
- Weight: 3 lb (1.4 kg)

#### Gaard Lock PET Syringe Shields with lead glass window:

<b>007-716</b>	Syringe Shield, 3 cc
<b>007-717</b>	Syringe Shield, 5 cc
<b>007-718</b>	Syringe Shield, 10 cc

#### Replacement:

<b>007-974</b>	Glass, Replacement For 007-716, 007-717, 007-718, 007-961, 007-962, 007-969, 007-973, 007-975 and, 007-980.
----------------	---



### Z-PET Syringe Shield

The Z-PET Syringe Shield greatly reduces hand exposure from syringes containing 511 keV radionuclides. The barrel of the shield is constructed of .55" thick tungsten that attenuates FDG F-18 by 97%. The shield accommodates standard 5 cc syringes.

#### Features:

- Extra thick wall for extra protection
- Constructed of .55" thick tungsten, attenuates FDG F-18 by 97%
- Easily sanitized with alcohol wipes

#### Specifications:

- Dimensions: 2.75" l x 1.7" dia. (7 x 4.3 cm)
- Shielding: .55" thick (14 mm) tungsten
- Weight: 3.7 lb (1.7 kg)

<b>007-945</b>	Syringe Shield, Z-PET, 5 cc*
----------------	------------------------------

\*Z-PET Syringe Shield was conceived by Michael Zimmer, Ph.D.

## Shielding & Storage



### Pro-Tec™ PET Syringe Shield

The Pro-Tec PET Syringe Shield reduces hand exposure from syringes containing 511 keV radionuclides. The syringe shield is offered with a high density (5.6) flush mounted lead glass window that provides protection and visibility. A white reflective surface on the shield interior improves viewing of the syringe's markings and fluid content. A thumbscrew holds syringes firmly in place.

**Features:**

- .34" thick tungsten attenuates FDG F-18 by 88%
- Available with a high density lead glass window
- Fits most disposable syringes
- Easily sanitized with alcohol wipes

**Specifications:**

007-973 Syringe Shield, 3 cc	007-975 Syringe Shield, 5 cc	007-980 Syringe Shield, 10 cc
• Dimensions: O.D.: 1.160" (2.945 cm) I.D.: .480" (1.21 cm) Length: 2.75" (6.98 cm)	• Dimensions: O.D.: 1.280" (711 cm) I.D.: .600" (1.52 cm) Length: 2.75" (6.98 cm)	• Dimensions: O.D.: 1.440" (3.65 cm) I.D.: .760" (1.930 cm) Length: 3.280" (8.33 cm)
• Shielding: .34" thick (9 mm) tungsten		
• Lead Glass: 5.6 density		
• Weight: 007-973: 1.4 lb (.64 kg) 007-975: 1.7 lb (.77 kg) 007-980: 2.3 lb (1.05 kg)		

**Pro-Tec PET Syringe Shields with lead glass window:**

<b>007-973</b>	Syringe Shield, 3 cc
<b>007-975</b>	Syringe Shield, 5 cc
<b>007-980</b>	Syringe Shield, 10 cc

**Replacement:**

<b>007-974</b>	Glass, Replacement For 007-716, 007-717, 007-718, 007-961, 007-962, 007-969, 007-973, 007-975 and 007-980.
<b>007-968</b>	Syringe Shield Replacement Screws, 15 pkg



### Pro-Tec™ PET/MR Syringe Shield

This non-magnetic, Pro-Tec PET/MR Syringe Shield reduces hand exposure from syringes containing 511 keV radionuclides. The barrel of the shield is constructed of .34" thick tungsten, which attenuates FDG F-18 by 88%. The shield is clearly labeled and engraved as MR safe to avoid confusion.

A 5.6 high density, flush-mounted, lead-glass window provides additional protection and optimal visibility. A white reflective surface on the shield interior improves viewing of the syringe's markings and fluid content. A thumbscrew holds syringes firmly in place.

Pro-Tec PET/MR Syringe Shields accommodate the standard sized 3 cc and 5 cc syringes.

**Features:**

- MR Conditional for 3T
- Ideal for the administration of high-energy isotopes for PET/MR imaging
- Constructed of .34" thick tungsten; attenuates FDG F-18 by 88%
- Easily sanitized with alcohol wipes

**Specifications:**

- Shielding: .34" thick (9 mm) tungsten
- Lead Glass: 5.6 density

**Pro-Tec PET/MR Syringe Shields with lead glass window:**

<b>007-961</b>	Syringe Shield, 3 cc
<b>007-962</b>	Syringe Shield, 5 cc

**Replacement:**

<b>007-974</b>	Glass, Replacement For 007-716, 007-717, 007-718, 007-961, 007-962, 007-969, 007-973, 007-975 and, 007-980.
<b>007-968</b>	Syringe Shield Replacement Screws, 15 pkg

## Shielding &amp; Storage

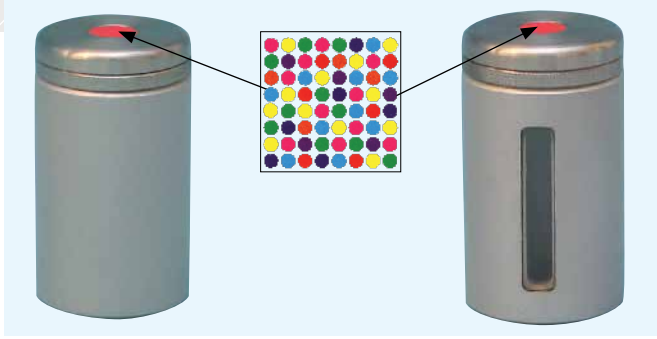

### Lead Vial Shield with Magnetic Cap

*Color coding for easy identification*

Designed to facilitate quick and easy access, the Lead Vial Shield features a tungsten screw top with a magnetic cap. For easy identification, a recessed hole is located on the top of the cap to accommodate a colored label.

The body of the vial shield is machined with 0.31" thick lead, accommodating most 10 ml vials.

A 4.2 density lead glass window provides protection and visibility.

#### Features:

- Magnetic cap designed to facilitate minimal handling
- .31" lead shielding
- Virtually unbreakable tungsten top
- Available with or without glass window
- Includes multi-colored labels for easy identification

#### Specifications:

- Dimensions:  
O.D.: 1.7" dia. x 3.0" h (4.3 x 7.6 cm)  
I.D.: 1.05" dia. x 2.24" h (2.7 x 5.7 cm)
- Lead Shielding: 0.31" thick (.79 cm)
- Lead Equivalency: 0.286" thick lead for Tc-99m
- Accommodates Vial Size: 10 ml
- Weight: 2.2 lb (1 kg)

<b>053-610</b>	Vial Shield, 0.31" lead, Magnetic Cap <i>Includes a sheet of colored labels</i>
<b>053-611</b>	Vial Shield, 0.31" lead, Magnetic Cap, with glass <i>Includes a sheet of colored labels</i>

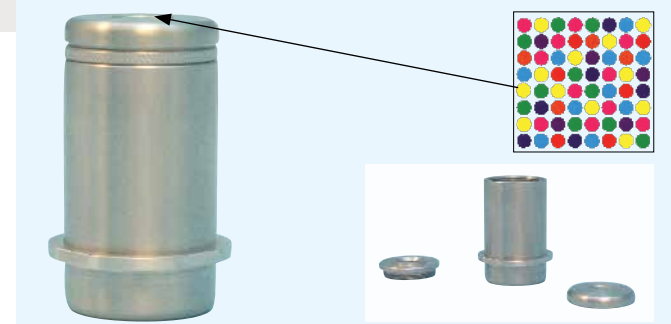

### Tungsten Lead Vial Shield with Magnetic Cap

*Designed with holding ring for hand ergonomics or inverted placement in dispensing station.*

Designed for vials containing liquid radioisotopes, the Tungsten Vial Shield features a removable screw top with a magnetic cap. Speed of handling reduces exposure. Another design feature is the holding ring which fits comfortably in the hand or into a dispensing stand. The magnetic cap holds the lid in place even when inverted on the stand.

Machined with 0.2" thick tungsten, the vial shield accommodates most 10 ml vials.

#### Features:

- Magnetic cap requires less handling, reduces hand exposure
- Virtually unbreakable
- Includes multi-colored labels for easy identification

#### Specifications:

- Dimensions:  
O.D.: 1.44" dia. x 2.99" h (3.7 x 7.59 cm)  
O.D.: (at grip ring): 1.74" dia. x 2.99" h (4.4 x 7.59 cm)  
I.D.: 1.02" dia. x 2.25" h (2.6 x 5.7 cm)
- Attenuation: > 99% for Tc-99m
- Tungsten Shielding: 0.2" thick (.51 cm)
- Lead Equivalency: 0.286" thick lead for Tc-99m
- Accommodates Vial Size: 10 ml
- Weight: 1.75 lb (0.80 kg)

<b>053-806</b>	Vial Shield, 0.2" Tungsten, Magnetic Cap <i>Includes a sheet of colored labels</i>
----------------	---

## Shielding & Storage



### Tungsten Vial Shield

The Tungsten Vial Shield is designed to greatly reduce exposure to vials containing liquid radioisotopes. The shield is machined with 0.2" thick tungsten, equivalent to 0.286" lead at 140 keV.

The tungsten will retain its shape under the roughest handling conditions and is virtually unbreakable.

**Features:**

- Virtually unbreakable
- Safe handling of radioactive liquids

**Specifications:**

- Dimensions:  
O.D.: 1.44" dia. X 2.8" h (3.7 x 7 cm)  
I. D.: 1" dia. x 2.25" h (2.5 x 5.7 cm)
- Attenuation: > 99% for Tc-99m
- Tungsten Shielding: 0.2" thick (.51 cm)
- Lead Equivalency: 0.286" thick lead for Tc-99m
- Accommodates Vial Size: 10 ml
- Weight: 1.65 lb (0.75 kg)

**053-807** Vial Shield, Tungsten



### Lead Vial Shield

This Vial Shield is designed to aid in preparation of radiopharmaceuticals that require boiling.

Vents are located to minimize scatter leakage, boiling water can circulate freely around the vial, heating the solution rapidly and uniformly. The carrying handle makes it easy to lower and remove the vial from the boiling water bath.

The vial is constructed of lead .25" thick. A 5.6 density flush mounted lead glass window provides protection and visibility. The radiation level for 25 mCi of Tc-99m is reduced to background.

**Specifications:**

- Dimensions: 2" dia. x 3.875" h (5 x 9.8 cm)
- Lead Shielding: .25" thick (.64 cm)
- Accommodates Vial Sizes:  
up to 1.5" dia. x 3.125" h (3.8 x 7.9 cm)
- Weight (including handle): 3 lb (1.4 kg)

**001-236** Vial Shield, .25" lead



### PET Vial Pig

Vials containing PET or other high-energy radionuclides can be safely transported in this Vial Pig. The pig offers a minimum of 1" of lead shielding to accommodate the concentrated energy.

The Vial Pig can be used independently or with the PET Shipping System, which meets DOT II Type A packaging requirements.

**Specifications:**

- Dimensions:  
O.D: 6.63" h x 4.15" dia. (16.8 x 10.5 cm)  
I.D: 2.76" h x 1.51" dia. (7 x 4.4 cm)
- Lead Shielding:  
Sides and Bottom: 1" thick (2.5 cm)  
Top: 1.75" (3.8 cm)
- Weight: 21.3 lb (9.7 kg)

**001-706** Pig, Vial, PET, 1" lead  
Transports 10\*, 20\* &  
30 ml vials.  
*\*Requires Vial/Pig  
Adapter, sold separately.*

**Related:**  
**001-771** Sheets, Absorbent,  
100/pkg  
**001-707** Adapter, Vial Pig, 10 ml  
*Allows 001-706 Vial Pig to  
accommodate 10 ml vials*  
**001-711** Adapter, Vial Pig, 20 ml  
*Allows 001-706 Vial Pig to  
accommodate 20 ml vials*

## Shielding & Storage



### High Density Lead Glass Vial Shield

The High Density (5.6) Lead Glass Vial Shield reduces hand exposure and offers complete 360° visibility. The lead glass vial shield is suitable for low-energy radioisotopes. The shield has a removable cap that makes cleaning and needle insertion as simple as possible while maintaining a sleek attractive appearance. Automatic centering action positions vials within the shield and holds them securely for extra safety and convenience.

#### Features:

- Lead glass provides clear visibility
- Accommodates most vials
- Centering action holds vials securely

#### Specifications:

- Lead Equivalency: .12" (3 mm)
- HVL for 99m-Tc: 10
- Accommodates Vial Sizes: 5 through 30 ml
- Weight: 3 lb (1.4 kg)

**001-075** Vial Shield,  
.12" lead equiv.

**Related:**  
**066-536** Forceps, Curved,  
non-locking, 12.5" l  
(31.7 cm)



*For added protection,  
store loaded syringes  
in the Shielded Syringe  
Holder.*

### Shielded Syringe Holder

*Accommodates shielded and  
unshielded syringes*

This Shielded Syringe Holder will accommodate unshielded syringes and syringes in a syringe shield.

The Syringe Holder is constructed of lead shielding, encased in steel. The shielding tapers from .25" - .5" lead. The large diameter base ensures stability.

#### Specifications:

- Dimensions: 6.5" h (16.5 cm)  
I.D.: .84" dia. x 5.6 h (2.1 x 14.3 cm)
- Lead Shielding: .25" - .5" thick  
(.64 cm - 1.3 cm)
- Accommodates Syringe Shields:  
Pro-Tec II: 1 cc, 3 cc, 5 cc  
Pro-Tec III: 1 cc, 3 cc, 5 cc  
Pro-Tec IV: 1 cc
- Weight: 6 lb (2.7 kg)

**009-205** Syringe Holder, Shielded



### Syringe Shield Holder

*Protect your investment*

Don't let your syringe shields roll around on the counter. The Syringe Shield Holder offers a means of protecting syringe shields from scratches or misplacement while freeing up extra work space. The Syringe Shield Holder will support up to eight shields and is counterbalanced to prevent tipping. Know exactly where syringe shields are when you need them.

#### Specifications:

- Dimensions: 7.5" w x 4" depth x 6" h  
(19 x 10.2 x 15.2 cm)
- Weight: 5 lb (2.3 kg)

**007-999** Syringe Shield Holder



## Shielding & Storage



### Shielded Syringe Carriers

Shielded Syringe Carriers reduce exposure while storing or transporting radioactive material. The overlapping lid design with snap-latch closure prevents streaming. There are two sizes, offered in .125" and .25" lead shielding for added protection. The ends of the carriers are double thick to reduce the exposure from the ends of syringes.

#### Specifications:

001-179 Shielded Syringe Carrier, Large

- Dimensions:  
I.D.: 8.25" l x 3" w x 2.9" h  
(21 x 7.6 x 7.4 cm)  
O.D.: 9.5" l x 4.4" w x 3.5" h  
(24 x 11.2 x 8.9 cm)
- Lead Shielding:  
Sides, top and bottom:  
.125" thick (.32 cm)  
Ends: .25" thick (.64 cm)
- Weight: 11.3 lb (5.1 kg)

001-181 Shielded Syringe Carrier, Small

- Dimensions:  
I.D.: 8" l x 1.9" w x 1.97" h  
(20.3 x 4.8 x 5 cm)  
O.D.: 9.25" l x 3.4" w x 2.6" h  
(23.5 x 8.6 x 6.6 cm)
- Lead Shielding:  
Sides, top and bottom:  
.125" thick (.32 cm)  
Ends: .25" thick (.64 cm)
- Weight: 7.5 lb (3.4 kg)

001-182 Shielded Syringe Carrier, Small

- Dimensions:  
I.D.: 7.5" l x 1.7" w x 1.7" h  
(19 x 4.3 x 4.3 cm)  
O.D.: 9.25" l x 3.4" w x 2.6" h  
(23.5 x 8.6 x 6.6 cm)
- Lead Shielding:  
Sides, top and bottom:  
.25" thick (.64 cm)  
Ends: .5" thick (1.3 cm)
- Weight: 11 lb (4.9 kg)

001-180 Shielded Syringe Carrier, Large

- Dimensions:  
I.D.: 7.7" l x 2.6" w x 2.7" h  
(19.6 x 6.6 x 6.9 cm)  
O.D.: 9.5" l x 4.4" w x 3.5" h  
(24 x 11.2 x 8.9 cm)
- Lead Shielding:  
Sides, top and bottom:  
.25" thick (.64 cm)  
Ends: .5" thick (1.3 cm)
- Weight: 17 lb (7.7 kg)

#### Shielded Syringe Carrier, .125" lead:

- 001-181** Syringe Carrier, Small
- 001-179** Syringe Carrier, Large

#### Shielded Syringe Carrier, .25" lead:

- 001-182** Syringe Carrier, Small
- 001-180** Syringe Carrier, Large



Eliminate clutter and reduce safety hazards with convenient Shielded Storage Containers.



Molded plastic liner with threaded lid fits Storage Container 050-250.

### Shielded Storage Containers

For beta and gamma radiation

Shielded Storage Containers are useful for storing used syringes, alcohol wipes, etc., that may be contaminated with low-energy gamma or beta radiation residue prior to disposal.

All sizes are fashioned of lead-lined stainless steel, but the 050-205 is lined with both lead and aluminum. This shielding combination attenuates gamma radiation, beta radiation and errant bremsstrahlung.

#### Specifications:

050-200 Shielded Storage Container, Gamma, Small

- Dimensions: 6.5" h x 5" dia. (16.5 x 12.7 cm)
- Lead Shielding: .125" thick (.32 cm)
- Weight: 7 lb (3.2 kg)

050-250 Shielded Storage Container, Gamma, Large

- Dimensions: 7" h x 6" dia. (17.8 x 15.2 cm)
- Lead Shielding: .125" thick (.32 cm)
- Weight: 9 lb (4.1 kg)

050-205 Shielded Storage Container, Beta/Gamma, Small

- Dimensions: 6.5" h x 5" dia. (16.5 x 12.7 cm)
- Lead Shielding: .25" thick (.64 cm)
- Aluminum Shielding: .0625" thick (1.6 mm)
- Weight: 12 lb (5.4 kg)

- 050-200** Shielded Storage Container, Gamma, Small, Stainless Steel, Lead Lined
- 050-250** Shielded Storage Container, Gamma, Large, Stainless Steel, Lead Lined
- 050-205** Shielded Storage Container, Beta/Gamma, Small, Stainless Steel, Lead/Al Lined

#### Related:

- 007-007** Liner, Molded Plastic, 12/pkg  
Fits 050-250
- 040-315** Liner, Poly Bag, 100/pkg  
Measures 6" x 3" x 15"  
Fits 050-200, 050-250 and 050-205



## Shielding & Storage



Monoject Sharps  
Container  
0660-1811.

### Vertical Drop CII Sharps Shield

*A convenient way to store spent syringes in a safe manner*

These Sharps leaded container cabinets offer a convenient way to store spent syringes in a safe manner. Two sizes are shown: One is designed for containment of one medium-size Chimney-Top Monoject Sharps container and the other holds two small or one large Monoject Sharps Container.

The Vertical Drop CII Sharps Shield comes with a Key-Lock safety feature not found elsewhere. The hinged top is easily opened to remove the Sharps container for replacement, requiring no removal of a heavy lid. Shielded with 1/8" lead, this unit can be specified with 1/4" shielding. The Vertical Drop CII Sharps is designed to use a Chimney-Top Sharps Container which protects the user's fingers in use. Convenient needle notches facilitate safe and rapid removal of needles from tube holders.

#### Features:

- All units have Key-Lock tops to meet OSHA requirements
- Table Top or Flush Mount in work counter
- Single or double stacked models
- Lead thickness 1/8" or 1/4"
- Hinged top for easy opening and removal of sharps

#### Specifications:

- Standard Model  
Shielding: .125" lead with 4 pi shielding  
Dimensions: 11" h x 7.25" w x 11" l (28 x 18.4 x 28.2 cm)  
Weight: 54 lb (24.5 kg)
- Tall Model  
Shielding: .125" lead with 4 pi shielding  
Dimensions: 18" h x 7.25" w x 11" l (45.7 x 18.4 x 28 cm)  
Weight: 76 lb (34.5 kg)

<b>0660-0018</b>	Vertical Drop CII Sharps Shield (Standard)
<b>0660-0019</b>	Vertical Drop CII Sharps Shield (Tall)
<b>0660-1811</b>	Monoject Sharps Medium (For Standard) 20/box
<b>0660-1813</b>	Monoject Sharps Small (For Tall) 40/box



### Horizontal Drop CII Sharps Shield

*Comes with hinged top and easy opening*

These Sharps leaded containers are available for Nuclear Medicine needs. Designed for containment of one medium size Horizontal-Entry Monoject Sharps Container or one medium Gator Sharps container.

The Horizontal Drop CII Sharps Shield comes with a Key-Lock safety feature, and hinged top with easy opening for replacement. Shielded with 1/8" lead, this unit can be specified with 1/4" shielding. The Horizontal Drop CII Sharps is designed to use a Horizontal-Entry Sharps Container with greater filling capacity since the syringes lie flat.

#### Features:

- All units have Key-Lock tops to meet OSHA requirements
- Lead thickness 1/8" or 1/4"
- Hinged top for easy opening and removal of sharps

#### Specifications:

- Shielding: .125" lead with 4 pi shielding
- Interior Dimensions: 11" h x 7.25" w x 11" l (28 x 18.4 x 28.2 cm)
- Exterior Dimensions: 12.625" h x 9.19" w x 13.75" l (32 x 23.34 x 35 cm)
- Weight: 52 lb (23.6 cm)

<b>0660-0038</b>	Horizontal Drop CII Sharps Shield (Standard)
------------------	--

## Shielding & Storage

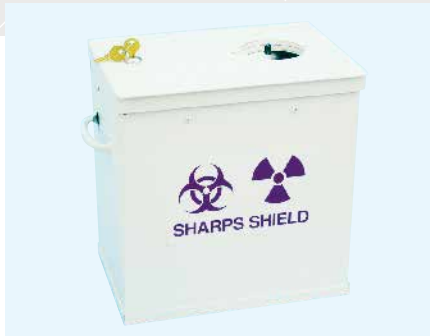

### High-Energy Sharps Container Shield

This Sharps Container Shield is a simple, safe and convenient solution for disposal of used syringes that may be contaminated with high-energy isotopes such as I-131. The shield is constructed of steel lined with .5" of lead (1.3 cm).

The shield features a hinged top with a sliding port and side handles which allow for easy transport. It will accommodate both small and medium Monoject Sharps containers.

#### Specifications:

- Dimensions:  
I.D.: 7" l x 11.38" w x 11.25" h  
O.D.: 9.19" l x 15.25" w x 13.31" h
- Lead Shielding: .5" thick (1.3 cm)
- Security: Key-locked
- Finish: Powder coat
- Weight: 160 lb (72.3 kg)

**039-326** Sharps Container Shield,  
.5" lead



0660-0042 PET  
Sharps Insert.

### PET Sharps Container Shield

*Hinged cover for syringe disposal*

The Capintec PET Sharps Container Shield is constructed to stand alone or to be recessed within a countertop. The shield is constructed of steel with 1" lead lining and allows for simple and convenient disposal of 511 keV radionuclides.

#### Features:

- Hinged cover for syringe disposal
- Sliding top with lock for container removal

#### Specifications:

- Dimensions:  
13.5625" h x 10.625" od x 6.125 id  
(34.4 x 27 x 15.6 cm)
- Weight: 160 lb (72.6 kg)
- Lead Lining: 1" (2.5 cm)

**5730-2271** PET Sharps  
Container Shield

**Related:**  
**0660-0042** PET Sharps Inserts



### Syringe Recapper

*Syringe recapping device*

Don't put yourself at risk with an accidental needle stick! The Syringe Recapper is a safe and inexpensive way to protect yourself when recapping a used syringe. Used either hand-held or placed on a flat surface, such as a procedure tray, the Recapper is made of a lightweight plastic that is easily carried anywhere.

#### Specifications:

- Dimensions: 3.25" l x 2.75" w  
(8.3 x 7 cm)

**008-300** Syringe Recapper

## Shielding & Storage



### Shielded Waste Container

*For low-energy beta and gamma waste*

This Shielded Waste Container is used in facilities that generate low-energy beta and gamma radiation waste. The interior of the container is constructed of .063" aluminum and .25" lead. The shielding combination attenuates gamma radiation, beta radiation and errant bremsstrahlung.

Extra protection is provided with a specially designed hatch door that protects the user from container contents even while open. Convenient side handles let you easily lift the container top to empty decayed contents. Sleek and sturdy, the exterior is constructed of steel, with a powder-coat finish.

#### Specifications:

- Dimensions: 12" w x 22" h x 9" d (30 x 56 x 23 cm)  
I.D.: 10.5" w x 14.5" h x 8.5" d (27 x 37 x 22 cm)
- Lead Shielding: .25" thick (6 mm)
- Aluminum Shielding: .063" thick (1.6 mm)
- Finish: Powder coat
- Shipping Weight: 120 lb (54 kg)

**039-110** Waste Container, Shielded, .25" lead  
*Includes 20 Poly Liners*

**Replacement:**  
**040-108** Liner, Poly, 20/pkg



### Shielded Waste Container

*For low-energy gamma waste*

The Shielded Waste Container is a must-have item for any facility that generates low-energy gamma radiation waste. Constructed entirely of 18-gauge stainless steel and lined with .125" lead, this 20-quart container can be placed on the floor or counter. Simply lift off the shielded cover for quick disposal of waste. Plastic liners make it easy to transfer waste to a decay or disposal site once the container is filled.

#### Specifications:

- Dimensions: 11.9" w x 9.9" depth x 15.25" h (30.2 x 25.1 x 38.7)
- Lead Shielding: .125" thick (3 mm)
- Capacity: 20 qt (18.9 L)
- Weight: 51 lb (22.6 kg)

**039-106** Waste Container, Shielded, .125" lead  
*Includes 20 Poly Liners*

**Replacement:**  
**040-108** Liner, Poly, 20/pkg



### 12 Gallon Step Waste Can

*Reduces hand exposure*

#### Features:

- Rugged Steel Construction
- Positive leverage foot pedal with hinged lid for hands-free operation
- Shielded with 1/8" of lead - ideal for low energy radioactive waste
- Includes rigid spill proof liner
- Available in durable white glossy finish or stainless steel exterior

#### Specifications:

- Dimensions: 23" h x 12" d x 12" w (58.4 x 30.5 x 30.5 cm)
- Weight: 80 lb (36.3 kg)
- Circumference: 48" (121.92 cm)
- Capacity: 12 gal (45.4 kg)

**5530-20179** 12 Gallon Step Waste Can, Stainless Steel

## Shielding & Storage

### Compact PET Shipping Systems for One, Two or Three Unit Dose Pigs

The Compact PET Shipping Systems transport one, two or three 3 cc or 5 cc doses containing high-energy radionuclides such as FDG F-18. Dose syringes fit into the pig with or without an attached needle. The shipping container is designed to conserve space and minimize weight. An important feature is that the shipping container can be left at a convenient height while the pig (9 lb) can be easily removed from the container. The pig is then placed behind an L-Block Shield for dose loading and unloading.

Compact PET Shipping Systems for one, two or three unit dose pig(s) consist of:

- PET Unit Dose Pig(s)
- Absorbent sheets
- Shipping container with lead shielding

#### Specifications:

001-786 PET Shipping System, Single Dose

- Dimensions:  
Container: 11.75" l x 11.75" w x 12.5" h (29.8 x 29.8 x 31.8 cm)  
Cubic Feet: ~1 cu ft (.03 cu meters)
- Weight (Combined): 38.3 lb (17.5 kg)
- Regulations:  
Meets DOT Yellow II Type A packaging requirements when shipping up to 500 mCi (18.5 GBq) of FDG F-18



001-787 PET Shipping System, Double Dose

- Dimensions:  
Container: 11.75" l x 11.75" w x 12.5" h (29.8 x 29.8 x 31.8 cm)  
Cubic Feet: ~1 cu ft (.03 cu meters)
- Weight (Combined): 55.2 lb (25.2 kg)
- Regulations:  
Meets DOT Yellow II Type A packaging requirements when shipping up to 160 (5.92 GBq) and 235 mCi (8.70 GBq) of FDG F-18



001-739 PET Shipping System, Triple Dose

- Dimensions:  
Container: 11.75" l x 11.75" w x 12.5" h (29.8 x 29.8 x 31.8 cm)  
Cubic Feet: ~1 cu ft (.03 cu meters)
- Weight (Combined): 95 lb (43.1 kg)
- Regulations:  
Meets DOT Yellow II Type A packaging requirements when shipping up to 235 (8.70 GBq), 160 (5.92 GBq) and 140 mCi (5.18 GBq) of FDG F-18  
Meets IATA Dangerous Goods Regulations, 60th Edition Sections 5.0.4.3, 10.5, and 10.6.1 through 10.6.3.5
- Compliance reports for radioactive materials packaging are available by request.



001-786 PET Single Dose Shipping System.



001-787 PET Double Dose Shipping System.

## Shielding & Storage



001-739 PET Triple Dose Shipping System.



### PET Unit Dose Pig

The 001-785 Unit Dose Pig is encapsulated in durable, high-impact Lexan and polypropylene, making the pig durable, easy to clean and compatible with automatic washing systems. All PET L-Block Shields incorporate a hex-shaped plate that corresponds with the hex shape at the base of the pig. This design element allows one-handed loading and unloading of syringes. A single twist opens or closes the pig, reducing handling time.

#### Features:

- Single twist thread to open and close
- No exposed lead
- Compatible with automatic washing equipment

#### Specifications:

- Dimensions: 10.2" h x 2.4" dia. (26 x 6 cm)
- Lead Shielding:
  - Body: .5" thick (1.3 cm)
  - Ends: Top: 1.44" thick (3.6 cm)
  - Bottom: 1.2" thick (3 cm)
- Weight: 8.7 lb (4 kg)

- 001-786** Shipping System, PET, Single Dose  
*For single Unit Dose Pig*  
*Includes: 001-785 Unit Dose Pig, absorbent sheets and shipping container with lead shielding*
- 001-787** Shipping System, PET, Double Dose  
*For two single Unit Dose Pigs*  
*Includes: Two 001-785 Unit Dose Pigs, absorbent sheets and shipping container with lead shielding*
- 001-739** Shipping System, PET, Triple Dose  
*For three single Unit Dose Pigs*  
*Includes: Three 001-785 Unit Dose Pigs, absorbent sheets and shipping container with lead shielding*

#### Related:

- 001-284** Pig Rack, PET
- 001-730** Cart, Transport, PET Shipping System
- 001-771** Sheets, Absorbent, 100/pkg
- 001-726** Tags, Wire Security, 25/pkg  
*Used to identify unauthorized access*
- 001-721** Document Protector, 100/pkg

U.S. Patent No. 6,586,758  
U.S. Patent No. 6,822,253  
U.S. Patent No. 6,963,073  
U.S. Patent No. 7,019,317

- 001-785** Pig, Unit Dose, PET, 3/5 cc, .5" lead  
*Accommodates syringes with or without needle*
- 001-798** Pig, Unit Dose, PET, 10 cc, .5" lead  
*Accommodates a 10 cc syringe with or without needle, filled to 6cc*
- Note: Each Pig is sold in multiples of three.*

#### Related:

- 001-284** Pig Rack, PET
- 001-771** Sheets, Absorbent, 100/pkg



## Shielding & Storage

### Intego™ Vial Shipping System

The Vial Shipping System employs a unique Tungsten Vial Shield for use with the Medrad Intego PET Infusion System. Manufactured to Medrad specifications, the Vial Shield transports a 30 ml Hospira vial.

To lift or lower the vial within the container or the Intego Infusion System, a detachable handle is provided. Accommodation is made for the handle to travel with the shipping container.

The system meets DOT Yellow II Type A packaging requirements when shipping up to 2.5 Ci (92.5 GBq) of FDG F-18.

#### Specifications:

001-708 Vial Shield with Lifting Handle

- Weight: 15.2 lb (6.89 kg)

001-723 Intego Shipping Container

- Dimensions:  
Container: 11.75" l x 11.75" w x 12.5" h (29.8 x 29.8 x 31.8 cm)  
Cubic Feet: ~1 cu ft (.03 cu meters)
- Weight: 48.8 lb (22.1 kg)
- Weight (Combined): 64 lb (29 kg)
- Regulations:  
Meets DOT Yellow II Type A packaging requirements when shipping up to 2.5 Ci (92.5 GBq) of FDG F-18  
Meets IATA Dangerous Goods Regulations, 60th Edition Sections 5.0.4.3, 10.5, and 10.6.1 through 10.6.3.5
- Compliance reports for radioactive materials packaging are available by request.



- 001-708** Vial Shield, Tungsten, Intego  
For 30 ml Hospira vials.  
Includes lifting handle.
- 001-723** Shipping Container, Intego

#### Related:

- 001-730** Cart, Transport, PET Shipping System
- 001-726** Tags, Wire Security, 25/pkg  
Used to identify unauthorized access
- 001-721** Document Protector, 100/pkg

U.S. Patent No. 6,586,758



## Shielding &amp; Storage

**Compact PET Shipping System for Vial Pig**

The PET Shipping System for Vial Pigs is designed to transport a 10, 20 or 30 ml vial containing high-energy radionuclides. Designed to conserve space and minimize weight, the entire system weighs only 50 lb. An important feature is that the shipping container can be placed at a convenient height while the pig is easily removed from the shipping case. For added safety and convenience, the vial pig can then be placed in the 042-466 Dose Drawing System for drawing doses from the vial.

The system meets DOT Yellow II Type A packaging requirements when shipping up to 1.5 Ci (55.5 GBq) of FDG F-18.

PET Shipping System for Vial Pigs consists of:

- PET Vial Pig
- Absorbent Sheets
- Shipping Container with lead shielding

**Specifications:**

001-706 Vial Pig

- Dimensions:
  - Exterior: 6.63" h x 4.15" dia. (16.8 x 10.5 cm)
  - Interior: 2.76" h x 1.51" dia. (7 x 3.8 cm)
- Lead Shielding:
  - Sides and Bottom: 1" thick (2.5 cm)
  - Top: 1.75" (4.4 cm)
- Weight: 21.3 lb (9.7 kg)

001-724 PET Shipping System, Vial

- Dimensions:
  - Container: 11.75" l x 11.75" w x 12.5" h (29.8 x 29.8 x 31.8 cm)
  - Cubic Feet: ~1 cu ft (.03 cu meters)
- Weight (Combined): 49.7 lb (22.5 kg)
- Regulations:
  - Meets DOT Yellow II Type A packaging requirements when shipping up to 1.5 Ci (55.5 GBq) of FDG F-18
  - Meets IATA Dangerous Goods Regulations, 60th Edition Sections 5.0.4.3, 10.5, and 10.6.1 through 10.6.3.5
- Compliance reports for radioactive materials packaging are available by request.



**001-724** System, PET, Vial\*  
Includes: 001-706 Vial Pig and shipping container with lead shielding

**Components:**

**001-706** Pig, Vial, PET, 1" lead  
Transports 10\*, 20\* & 30 ml vials.  
\*Requires Vial/Pig Adapter, sold separately.

**Related:**

**001-707** Adapter, Vial Pig, 10 ml  
Allows 001-706 Vial Pig to accommodate 10 ml vials

**001-711** Adapter, Vial Pig, 20 ml  
Allows 001-706 Vial Pig to accommodate 20 ml vials

**001-730** Cart, Transport, PET Shipping System

**001-771** Sheets, Absorbent, 100/pkg

**001-726** Tags, Wire Security, 25/pkg  
Used to identify unauthorized access

**001-721** Document Protector, 100/pkg

U.S. Patent No. 6,586,758

## Shielding & Storage

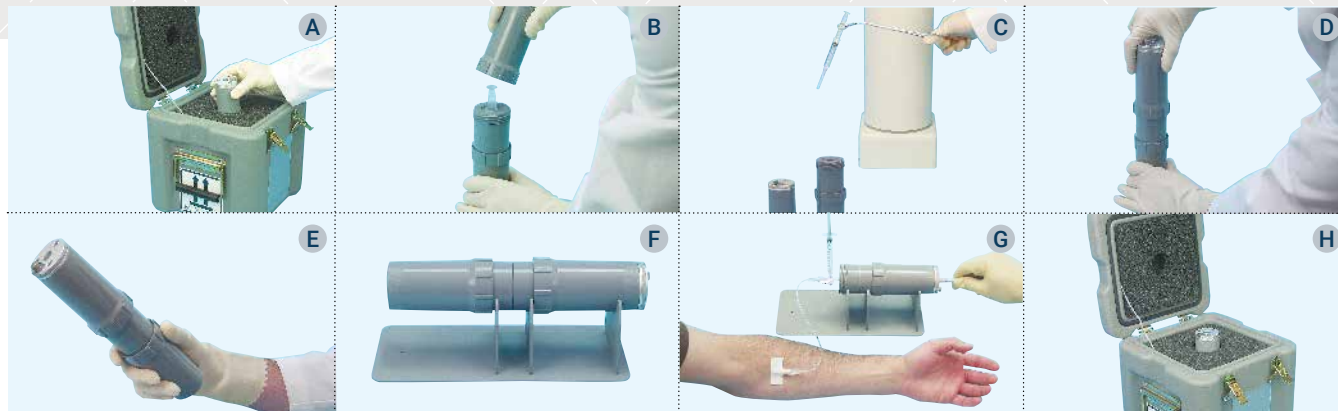

### Compact PET Shipping System for Double-Ended PET Pig

*One system for shipping and injecting FDG F-18*

The Double-Ended PET Pig is an all-in-one solution for the safe transport and administration of 511 keV radionuclides, such as FDG F-18. The pig is constructed in three sections of .6" (1.5 cm) lead enclosed in durable Lexan. Depending on the stage of the injection process, only one section of the pig is removed. The injection itself is accomplished without removing the syringe from the pig. Simply open the administration port and push the tungsten plunger against the syringe plunger. During injection the pig is positioned on a stand. The Double-Ended Pig accommodates a 5 cc syringe and fits into its own compact shipping container. The system employs a unique design that decreases the weight and size of the container.

#### Here's how it works:

1. Remove the Double-Ended Pig from the compact shipping container. (See dia. A.)
2. Place behind an L-Block Shield.
3. Unscrew the top. (See dia. B.)
4. Remove the syringe and place into a dose calibrator. (See dia. C.)
5. Return the syringe to the pig and put the top back on. (See dia. D.)
6. Transport the pig to the patient injection area. (See dia. E.)
7. Place the pig into the Pig Cradle so the top section of the pig is over the long section of the cradle. (See dia. F.)
8. Remove the bottom of the pig and connect to your preferred injection device, butterfly, etc. (See dia. G.)
9. Open the plunger lock located on the top section by pulling the slide toward the edge of the pig. With a pen-like device, push the tungsten plunger to administer the dose. (See dia. G.)
10. Recap the syringe.
11. Put the bottom back on the pig.
12. Return the pig to the compact shipping container. (See dia. H.)

#### Specifications:

001-793 Double-Ended PET Pig

- Dimensions: 9.5" h x 2.3" dia. at maximum point (24 x 5.8 cm)
- Shielding:
  - Sides: .6" thick (1.5 cm) lead
  - Bottom: 1.44" thick (3.7 cm) lead
  - Top: .875" thick (2.2 cm) tungsten
- Weight: 9 lb (4 kg)

001-794 PET Shipping System, Double-Ended Pig

- Dimensions:
  - Container: 11.75" l x 11.75" w x 12.5" h (29.8 x 29.8 x 31.8 cm)
  - Cubic Feet: ~1 cu ft (0.3 cu meters)
- Weight: 36 lb (16.3 kg)
- Regulations:
  - Meets DOT Yellow II Type A packaging requirements when shipping up to 475 mCi (17.58 GBq) of FDG F-18.
  - Meets IATA Dangerous Goods Regulations, 60th Edition Sections 5.0.4.3, 10.5, and 10.6.1 through 10.6.3.5.
- Compliance reports for radioactive materials packaging are available by request.



**001-794** Shipping System, PET, Double-Ended Pig, Single  
*Includes one 001-793 Double-Ended PET Pig and Shipping Container with lead.*

#### Component:

**001-793** Pig, Double-Ended, PET, .6" lead  
*Accommodates 5 cc syringes with or without needle.*

#### Related:

**001-771** Sheets, Absorbent, 100/pkg  
**001-721** Document Protector, 100/pkg

*U.S. Patent No. 6,586,758 B2  
Other patents pending*

## Shielding &amp; Storage

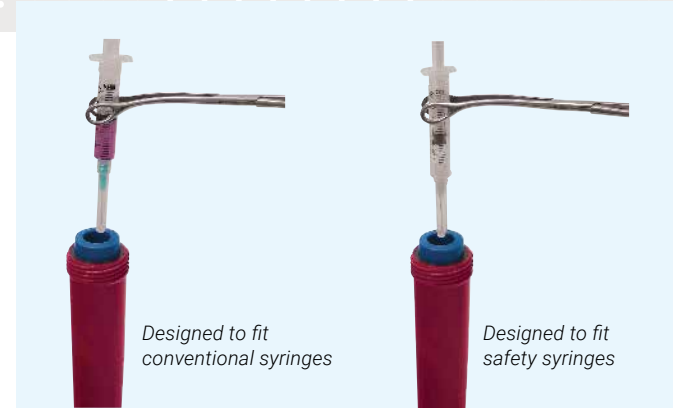

### Pro-Tec™ Unit Dose Pig

The Pro-Tec Unit Dose Pig accommodates the most commonly used conventional and safety-engineered syringes. The lead components are fully encapsulated in durable Lexan, making this unit rugged and easy to clean. A single twist to open or close reduces loading/unloading time. The overlap design eliminates streaming regardless of the dose's position inside the pig.

A replaceable O-ring protects against leakage. Complete encapsulation of lead components in high-impact Lexan protects the lead shielding from physical damage during handling. The durable Lexan will not be damaged by automatic washing systems. Smooth plastic surfaces make the application and removal of adhesive labels easy. This product is designed to comply with IATA and DOT II requirements when transported in an appropriate shipping container.

Innovative and cost effective, the Pro-Tec Unit Dose Pig will help improve the safety and efficiency of radiopharmaceutical handling procedures. Pro-Tec shielding for safety syringes will help pharmacies and clinics adhere to ALARA principles and improve compliance with OSHA directives – without compromising efficiency.

#### Features:

- Attractive design
- Overlapped lead eliminates streaming
- Durable, high-impact Lexan encapsulates lead components
- Opens and closes with a single twist
- 0.25" thick lead shielding
- O-ring seal
- Fits into ammo cans (vertically and horizontally)
- Compatible with automatic washing equipment
- Accommodates the following syringes:
  - 3 cc BD
  - 3 cc BD Safety-Lok
  - 3 cc Monoject
  - 3 cc Monoject Safety
  - 5 cc BD
  - 6 cc Monoject
  - 10 cc BD

#### Specifications:

- Dimensions: 8.5" h x 1.94" dia. (22 x 4.9 cm)
- Lead Shielding: 0.25" nominal thickness (0.64 cm)
- Construction: Lead, fully encapsulated with polycarbonate on the outside and polypropylene on the inside
- Color: Red, White, Blue
- Weight: 3 lb (1.4 kg)

- 001-280** Unit Dose Pig, Pro-Tec, Red  
**001-281** Unit Dose Pig, Pro-Tec, White  
**001-282** Unit Dose Pig, Pro-Tec, Blue

*Note: Each Pig is sold in multiples of six.*

U.S. Patent No. 6,822,253

U.S. Patent No. 6,963,073

U.S. Patent No. 7,019,317

#### Related:

- 008-400** Wall Rack, Unit Dose Pig  
**001-283** Pig Rack, Pro-Tec  
**001-754** Shipping Bag, Pro-Tec Pig

## Shielding & Storage



Accommodates up to 11 Pro-Tec Pigs

### Pro-Tec™ Pig Shipping Bag

The durable, nylon, waterproof shipping bag is designed to accommodate up to 11 Pro-Tec Pigs containing syringes, ensuring safe, convenient handling of syringes from the pharmacy and back again. The system meets DOT 7A Type A packaging requirements.

#### Specifications:

- Dimensions: 10.5" h x 5.75" w x 11.5 depth (26.7 x 14.6 x 29.2 cm)
- Material:
  - Exterior: Nylon
  - Interior: Polyester
- Regulations:
  - Meets DOT 7A Type A packaging requirements.
  - Meets IATA Dangerous Goods Regulations, 60th Edition Sections 5.0.4.3, 10.5, and 10.6.1 through 10.6.3.5.
- Compliance reports for radioactive materials packaging are available by request.



**001-754** Shipping Bag, Pro-Tec Pig

#### Related:

- 001-280** Unit Dose Pig, Pro-Tec, Red
- 001-281** Unit Dose Pig, Pro-Tec, White
- 001-282** Unit Dose Pig, Pro-Tec, Blue

#### Replacement:

- 001-756** Placard, Type I, 100/pkg
- 001-757** Placard, Type II, 100/pkg
- 001-779** Covers, hook & loop fasteners, plastic, Lg, 160 x 180 mm, 50/pkg

U.S. Patent No. 6,822,253  
 U.S. Patent No. 6,963,073  
 U.S. Patent No. 7,019,317



### Unit Dose Pigs In-111 or Y-90

Designed to reduce exposure from gamma emitting radiopharmaceuticals, the Zevalin In-111 Unit Dose Pig is constructed of lead, encased in a durable Lexan. The pig accommodates a 10 cc B-D syringe filled to capacity. The Y-90 Unit Dose Pig is constructed of lead and acrylic, encased in a durable Lexan. Reducing exposure from beta emitting radiopharmaceuticals, the pig accommodates a 10 cc B-D syringe filled to 9 cc.

#### Specifications:

- 001-789 In-111 Unit Dose Pig**
  - Dimensions: 10.3" l x 2.3" dia. (26 x 5.8 cm)
  - Lead Shielding: .5" thick (1.3 cm)
  - Weight: 8.2 lb (3.7 kg)
- 001-788 Y-90 Unit Dose Pig**
  - Dimensions: 10.3" l x 2.3" dia. (26 x 5.8 cm)
  - Lead Shielding: .09" thick (2.3 mm)
  - Acrylic Shielding: .36" thick (9.1 mm)
  - Weight: 3 lb (1.4 kg)

**001-789** In-111 Unit Dose Pig  
*Accommodates 10 cc syringe with or without needle, filled to 10 cc*

**001-788** Theranostics Unit Dose Pig with Acrylic Lining  
*Accommodates 10 cc syringe with or without needle, filled to 9 cc*

#### Related:

- 001-284** Pig Rack, PET
- 001-771** Sheets, Absorbent, 100/pkg

U.S. Patent No. 6,822,253  
 U.S. Patent No. 6,963,073  
 U.S. Patent No. 7,019,317

## Shielding & Storage



### Unit Dose Pig Wall Rack

Improve lab safety, efficiency and organization with the Unit Dose Pig Wall Rack.

The wall rack improves work space with its pigeonhole design and reduces unnecessary handling. Unit doses can be identified at a glance. The rack's sturdy construction will hold up to 25 unit dose pigs.

#### Specifications:

- Dimensions: 17" w x 18" h (43.2 x 45.7 cm)



### PET Pig Rack

Designed for countertop use, the PET Pig Rack holds up to eight PET pigs safely and conveniently.

The bottom of the rack has hexagonal cutouts that match the bottom of a pig to ensure each pig is held securely. When inserted into the rack, the pig can be easily opened or closed with a single twist.

#### Specifications:

- Dimensions: Overall: 12" w x 1.75" h x 6" depth (30.5 x 4.4 x 15.2 cm)  
Upper holes: 2" dia. (5 cm)  
Lower holes: 1.625" hex (4.1 cm)
- Weight: 2.8 lb (1.3 kg)



### Pro-Tec™ Pig Rack

Designed for countertop use, the Pro-Tec Pig rack holds up to ten Pro-Tec Pigs safely and conveniently. The bottom of the rack has hexagonal cutouts that match the bottom of a Pro-Tec Pig to ensure each pig is held securely. When inserted into the rack, the pig can be easily opened or closed with a single twist.

#### Specifications:

- Dimensions: Overall: 12" w x 1.75" h x 6" depth (30.5 x 4.4 x 15.2 cm)  
Upper holes: 1.5" dia. (3.8 cm)  
Lower holes: 1.2" hex (3.1 cm)
- Weight: 2.8 lb (1.3 kg)

**001-284** Pig Rack, PET

**Related:**  
**001-785** Pig, Unit Dose, PET, 3/5 cc, .5" lead  
**001-788** Theranostics Unit Dose Pig with Acrylic Lining  
**001-789** In-111 Unit Dose Pig

U.S. Patent No. 6,822,253  
 U.S. Patent No. 6,963,073  
 U.S. Patent No. 7,019,317

**001-283** Pig Rack, Pro-Tec

**Related:**  
**001-280** Unit Dose Pig, Pro-Tec, Red  
**001-281** Unit Dose Pig, Pro-Tec, White  
**001-282** Unit Dose Pig, Pro-Tec, Blue

U.S. Patent No. 6,822,253  
 U.S. Patent No. 6,963,073  
 U.S. Patent No. 7,019,317

**008-400** Wall Rack, Unit Dose Pig



## Shielding & Storage

### Compact L-Block with Dose Calibrator Shield

*Space-saving design – Ideal for mobile units*

The unique Compact L-Block with Dose Calibrator Shield is designed to maximize space in facilities receiving and preparing doses of high-energy nuclides such as FDG F-18. It provides convenient access and viewing of the work area and incorporates a built-in calibration chamber shield. The special shield accommodates a chamber that is through-mounted in a countertop (customer responsible for installation) and all Atomlab chambers and many others (see chamber shield specifications to determine fit). This combination of L-Block and dose calibrator shield eliminates the need to purchase interlocking shielding rings. It is constructed of lead encased in steel and features a large 8" x 8" x 4" lead glass window with adjustable window angle, 1.5" thickness lead shielding in front, and 1" thick lead in the base and in the chamber shield. A special plate with a hex-shaped recess is mounted on the L-Block base to facilitate one-handed loading and unloading of dose pigs incorporating hex-shaped bottoms. The optional 042-434 Lead Brick Cave fits into the sides of the vertical section to provide lateral shielding around the full perimeter of the base. For hot labs in mobile vans, the optional Lead Brick Cave Cover will prevent the cave from shifting when the vehicle is in motion.

#### Features:

- 1.5" thick lead shielding in front, 1" in base
- 8" x 8" x 4" adjustable lead glass window
- 1" thick lead shield surrounds calibration chamber
- Optional Lead Brick Cave for complete lateral shielding

#### Specifications:

##### 042-433 Compact L-Block with Dose Calibrator Shield

- Dimensions: 18" w x 21.5" depth x 26" h (45.7 x 54.6 x 66 cm)
- Lead Shielding:
  - Front: 1.5" thick (3.8 cm)
  - Base: 1" thick (2.5 cm)
  - Calibrator Shield: 1" thick (2.5 cm)
- Calibrator Shield Inside Dimensions: 6.85" id x 10.25" h (17.4 x 26 cm)
- Lead Glass Window:
  - Dimensions: 8" w x 8" h x 4" thick (20.3 x 20.3 x 10.2 cm)
  - Density: 5.2 g/cm<sup>3</sup>
- Finish: Powder coat
- Weight: 570 lb (259 kg)
- Shipping Weight: 590 lb (267.6 kg)

##### 042-434 Interlocking Lead Brick Cave

- Dimensions:
  - I.D.: 14" w x 20.5" depth x 16" h (35 x 52.1 x 40.6 cm)
- Lead Shielding: 2" thick (5 cm)
- Finish: Paint
- Weight: 597 lb (271 kg)

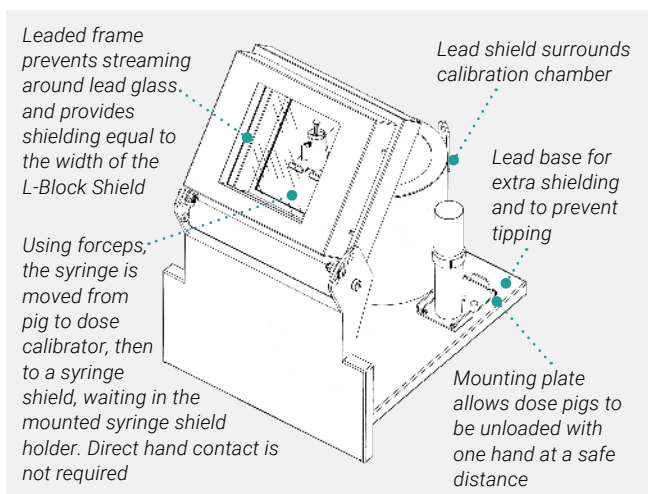

**042-433** Compact L-Block with Dose Calibrator Shield, 1.5" lead  
With built-in Dose Calibrator Shield

**Related:**  
**042-434** Lead Brick Cave, 3-wall, 2" lead  
Fits 042-433 L-Block Shield

**042-435** Lead Brick Cave Cover  
Fits 042-434 Lead Brick Cave

*Note: For use in countertops without a backsplash. Designed for mobile environments.*

*This L-Block Shields incorporate a hex-shaped plate to facilitate one-handed loading and unloading of PET Pigs.*



## Shielding & Storage

### 511 Spring Armed Dose Drawing Station

*Proprietary spring arm design*

The Capintec Dose Drawing Station was designed to help you meet the ALARA requirements of your department. With its proprietary spring arm design and exceptional shielding, the Dose Drawing Station is a fast and safety conscious way of handling your PET nuclides.

#### The Four Key Features

##### The Spring Arm

The Dose Drawing Station's proprietary spring arm design allows for quick and near effortless positioning of the 35 lb (16 kg) vial shield. With minimal exertion and minimal time the vial shield can be raised, lowered and/or inverted.

##### The 511 Vial Shield

There are two components to the vial shield. First is the inner T-vial shield, which is made of tungsten and provides a 1" (25.4 mm) lead equivalence. Second is the outer shield, which has 1" (25.4 mm) thick walls of epoxy-coated lead.

##### The Dose Drawing Syringe Shield

Included with the Dose Drawing Station is a Dose Drawing Syringe Shield in 5, 10 or 20 cc sizes. The syringe shield has a tungsten flange that provides maximum protection and locks onto the 511 vial shield with a twist of the wrist.

##### The 511 "L" Block Body Shield

Inside of the steel covering of the body shield lie interlocking 2 3/8" (6 cm) lead bricks. Mounted at a 20° angle on top of the steel cover is an 8" x 8" x 4" (51 x 51 x 25 cm) High Density lead glass view port.

#### Features:

- Designed for maximum radiation protection and greater flexibility when drawing doses
- Spring arm is constructed to provide ease of positioning and effortless lifting of the 35 lb tungsten vial
- Easily removable inner tungsten vial shield with 1" lead equivalence shielding
- Outer shield is 1" thick epoxy coated lead. In conjunction with the inner tungsten shield the user gets a combined 2" of lead shielding
- Flanged tungsten shield is manufactured to twist and lock into the tungsten vial shield. One flanged tungsten shield is included in the purchase of the dose drawing station. (When purchasing specify which shield size you would require, 5 cc, 10 cc or 20 cc)
- Lead glass is protected by 1/4" plate glass laminated to the front and back viewing surface to protect lead glass from scratching and chipping



#### Specifications:

- Dimensions: 22 1/2" w x 23 7/8" h x 22" d
- Lead Glass Window:  
8" w x 8" h x 4" thick  
Density: 5.2 g/cc density
- Lead Shielding: 2 3/8" Gapless lead shielding
- Weight: 250 lb

**5510-3003** Drawing Station with body shield

#### Related:

**0665-2017** 5 cc Dose Drawing Syringe Shield  
**5530-1031** Painted Dose Drawing Station Brick Kit  
12" h x 32" w x 24" d x 2" Thick  
(31 x 82 x 61 x 5 cm)

## Shielding & Storage

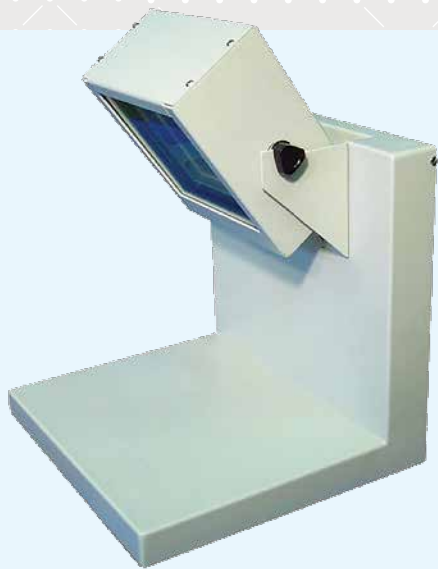

### 511 Adjustable L Block Table Top Shield

*Adjustable lead glass window from 30-55 degrees*

Designed to exceed the basic requirement of outstanding radiation protection, it now also boasts the luxury of an adjustable lead glass window for greater work area flexibility. The front wall shields with 2 3/8" thick lead and the window is 4" thick lead glass, with a clear glass cover to protect it from scratching. The front, base and glass frame are each constructed of high gauge steel for superior strength and stability.

Use the Adjustable L Block as a stand-alone unit. The optional Brick Kits (for side and back wall protection) will provide the perfect finishing touch for your 511 Adjustable L Block. The 511 "L" Block Shield is shipped in three pieces and easily assembled on site. Side walls are available as an option.

#### Features:

- Adjustable lead glass window from 30-55 degrees
- Clear glass covering to protect lead glass from chipping and scratching
- Steel construction for strength and stability
- Adjustable window angle of 30-55 degrees with respect to vertical

#### Specifications:

- Lead Shielding: 2 3/8" (6 cm)
- Lead Glass: 8" x 8" x 4" (20.32 x 20.32 x 10.16 cm) (5.2 density, 1.6" lead equivalence)
- Dimensions: 21" h x 15.75" w x 15.5" d (53.3 x 39 x 39.3 cm)
- Weight: 500 lb (227 kg)

**5530-2077** 511 Adjustable "L" Block Shield



### 511 L Block Table Top Shield

*8" w x 8" h x 4" thick 5.2 g/cc Lead Glass*

The 511 "L" Block Shield is placed in front of the Drawing Station and used to provide a protected work area for safe handling of 511 keV nuclides. The front wall and the base of the unit are constructed of steel with built-in lead shielding. A 4" thick lead glass window offers maximum protection and an unrestricted viewing area. In addition, the lead glass is protected from scratches and chips by a sheet of window.

#### Features:

- The fixed angle design of the lead glass allows easier viewing
- Contains two sheets of 1/4" window glass to protect lead glass from scratching and chips (Industry exclusive)
- Lead shielding thickness- 1.0" (2.54 cm)

#### Specifications:

- Dimensions: 20 1/4" h x 14" w x 14" d (51 x 35.5 x 35.5 cm)
- Lead Glass Density: 8" x 8" x 4" (20.32 x 20.32 x 10.16 cm) 5.2 g/cc
- Weight: 195 lb (89 kg)

**0665-2014** PET L-Block Shield with 4" Glass

#### Related:

**5530-1030** Painted Chevron Brick Kit  
12" h x 28" w x 16" d x 2" thick (41 x 71 x 30 x 5 cm)

## Shielding &amp; Storage



### 511 Stainless Steel "L" Shield

*Offers excellent protection from beta and gamma radiation*

This shield is designed for facilities that prepare and dispense high activity 131 therapy doses. The shield offers excellent protection from beta and gamma radiation and has a fully shielded floor. The lead glass is 2.7 inches thick to shield out the high energy gamma photons from this radionuclide.

#### Specifications:

- Dimensions: 17.64" h x 13.78" w x 12.2" d (44.8 x 35 x 40 cm)
- Lead Thickness: 1.42" (3.6 cm)  
11.61" w x 8.98" h (29.5 x 22.8 cm) x 2.68Tk 4.7 g/cm<sup>3</sup> density lead glass
- Weight: 227 lb (102.9 kg)

0550-0003 511 Stainless Steel "L" Block



### Standard "L" Block Shield

*Favorite as a drawing station*

The Standard "L" Shield is the favorite as a drawing station and as a storage shield for unit doses with easy access. Side shields or lead brick may be used to form walls when the Standard Shield is used to store higher activity or for additional shielding. Capintec offers shields with lead greater than the standard 1/2" when working with after loaders or PET products.

#### Features:

- .25" lead glass
- .5" lead shielding
- Optional Side Shield .25"
- Additional .25" Lead Glass
- Additional .25" plain glass

#### Specifications:

- Dimensions: 26" h x 18.5" w x 18.5" d (66 x 47 x 47 cm)
- Weight: 100 lb (45.35 kg)
- The lead glass of the Standard L Block Shield is 1/4" thick, which is equivalent to 1/16 inches of lead thickness
- Density of lead is 11.34 g/cm<sup>3</sup>

5130-2090 Standard "L" Shield

#### Related:

1000-0211 Additional Lead Glass for Standard  
7310-1305 Side Shields for Standard "L" Shield

## Shielding & Storage



### Mini "L" Block Shield

*Greatest in flexibility of positioning*

The Mini "L" Shield offers the greatest in flexibility of positioning. This smaller unit is perfect for those very small work areas where additional protection is required for temporary storage of syringes or vials. Excellent for remote stations where syringes must be filled or as an additional work station.

**Features:**

- .25" Lead Glass
- .5" Lead Shielding
- Additional .25" Lead Glass
- Additional .25" Plain Glass
- Optional Side Shielding .25"

**Specifications:**

- Dimensions: 16.75" h x 12" w x 12" d (42.5 x 30.5 x 30.5 cm)
- Weight: 35 lb (15.87 kg)

**5130-2086** Mini "L" Shield

**Replacement:**

**1000-0208** Additional Plain Glass for Mini "L" Shield

**7310-1302** Side Shields for Mini "L" Shield



### Stainless Steel "L" Shield

*Specially designed to protect staff 99m members working with Tc isotopes*

The Tech L-Block Shield is specially designed to protect staff 99m members working with Tc isotopes. This lead-containing L-Block Shield gives full protection to the technologist's torso while the leaded glass window allows the technologist full view of the work area and offers shielding from radiation. This is an excellent product for facilities that compound significant 99m quantities of Tc based radiopharmaceuticals.

**Features:**

- .59" (1.5 cm) lead glass
- Lead glass density of 4.77 g/cm<sup>3</sup>
- Lead thickness of .24" (.6 cm) front and bottom

**Specifications:**

- Dimensions: 15.16" h x 10.43" w x 10.08" d (38.5 x 26.5 x 25.6 cm)
- Weight: 40 lb (18.1 kg)

**5550-0002** Stainless Steel "L" Shield

## Shielding & Storage



### Beta Gamma "L" Block Shield

*For facilities that use both beta emitting and gamma emitting nuclides*

Manufactured by Capintec for facilities that use both beta emitting and gamma emitting nuclides.

#### Features:

- Utilizes all the specifications and features of the Standard "L" block, with a 1/4" acrylic plastic interior "L" Shield
- Two shields in one (Beta/Gamma)
- Avoid the hassle of switching out "L" blocks

#### Specifications:

- Dimensions: 15.75" w x 15.5" d x 13" h
- Weight: 100 lb (45.35 kg)
- The lead glass of the Standard L Block shield is 1/4" thick, which is equivalent to 1/16 mm of lead thickness
- Density of lead is 11.34 g/cm<sup>3</sup>

**5130-2090** Standard "L" Shield  
**5130-2161** Beta Shield Insert



### Clear-Pb "L" Block Shield

*Offers protection from low energy gamma and beta radiation*

This Clear-Pb table top "L" shield offers protection from low energy gamma and beta radiation while providing complete visibility of the work area. The truly portable shield is rugged, shatter-resistant and is made from a lead impregnated polymer providing full working accessibility plus full protection of your face and upper body. The Clear-Pb Shields are offered as a Mini 12" h x 9" w, Standard 18" h x 12" w, or Jumbo 24" h x 18" w sizes.

#### Features:

- Totally clear and distortion-free for easy viewing
- Provides 1.5 mm lead equivalency
- Portable for use in many areas

#### Specifications:

- Dimensions: 9" w x 12" h (230 x 305 mm)

Nuclide	Attenuation
I-125	99.9%
Xe-133	97.6%
Co-57	99.8%
Tc-99	98%
123	99.5%
Ga-67	67%

**5730-0032** Jumbo Clear Pb "L" Shield

## Shielding & Storage



for  
PET

### Chevron Interlocking Lead Brick

*For the best protection — Chevron Brick*

The flat surface of rectangular lead brick gives good protection. But for maximum protection, we offer interlocking chevron bricks. Their V-shaped edges allow safe and easy stacking to form a walled enclosure, thus minimizing the chance of collapsing. Capintec offers several sizes and thicknesses as well as end and corner brick to meet your particular requirements.

**Features:**

- Homogeneous and void free
- V-shaped (chevron) allowing no open joints
- Unlimited configurations

**Specifications:**

7410-0023 Standard

- Dimensions: 2" x 4" x 4" (5 x 10.1 x 10.1 cm x 6 kg)
- Weight: 13.2 lb (5.98 kg)

7410-0024 Base

- Dimensions: 2" x 4" x 4" 1(5 x 10.1 x 10.1 cm x 6.7 kg)
- Weight: 4.9 lb (2.22 kg)

7410-0025 Top

- Dimensions: 2" x 4" x 2" (5 x 10.1 x 5 cm x 2.8 kg)
- Weight: 6.23 lb (2.82 kg)

**7410-0023** Standard, Chevron Interlocking Lead Bricks  
**7410-0024** Base, Chevron Interlocking Lead Bricks  
**7410-0025** Top, Chevron Interlocking Lead Bricks

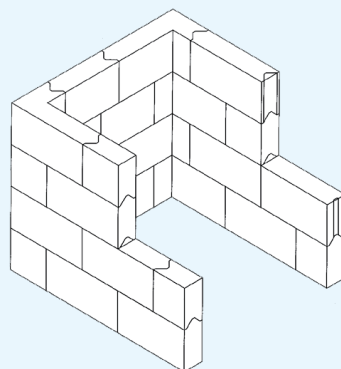

for  
PET

### Interlocking Lead Brick Caves

*Select a 3-walled cave or design your own*

The optional Lead Brick Caves fit neatly in the sides of the vertical section to provide lateral shielding around the perimeter of the L-Block's base. For hot labs in mobile vans, the optional Brick Cave Cover will prevent the cave from shifting when the vehicle is in motion.

**Specifications:**

042-434 Interlocking Lead Brick Cave

- Dimensions:  
I.D.: 14" w x 20.5" depth x 16" h (35 x 52.1 x 40.6 cm)
- Lead Shielding: 2" thick (5 cm)
- Finish: Paint
- Weight: 597 lb (271 kg)

5530-2074 3 Walled Brick Enclosure

- Dimensions:  
I.D.: 12" h x 20" w x 20" d (30.5 x 50.8 x 50.8 cm)
- Lead Shielding: 2" (5 cm) lead
- Weight: 475 lb (215.4 kg)

5530-1030 3 Walled Brick Enclosure

- Dimensions:  
I.D.: 12" h x 28" w x 16" d (30.5 x 71.1 x 40.6 cm)
- Lead Shielding: 2" (5 cm) lead
- Weight: 550 lb (249.4 kg)

**042-434** Lead Brick Cave, 3-wall, 2" lead  
*Fits 042-433 L-Block Shield*  
**5530-2074** 3-wall Brick Enclosure 2" lead  
**5530-1030** 3-wall Brick Enclosure 2" lead

**Related:**  
**042-435** Lead Brick Cave Cover  
*Fits 042-434 Lead Brick Cave*



## Shielding &amp; Storage



### Mobile Radiation Shield

The Compact Adjustable Height Radiation Shield is a versatile addition to any PET site. The 1" thick lead panel is 22" w x 19" h. The panel can be height adjusted within a 10" range. The shield can be used to protect technologists from sitting or lying "hot" patients. A fold down shelf is conveniently located to hold syringe shields, carriers and injectors, etc. Place shielding where and when it is needed. Wheel and swivel locks on each caster provide secure placement.

#### Specifications:

- Dimensions:  
24" w x 24.25" deep x 32.5" h  
(61 x 62 x 83 cm)  
Shield: 22" w x 19" h (56 x 48 cm)  
Folding Shelf: 24" w x 5" deep  
(61 x 12.7 cm)  
Height Adjustable: 35" to 45"  
(89 to 114 cm)
- Lead Shielding: 1" thick (2.5 cm)
- Finish: Powder coat
- Weight: 230 lb (104 kg)
- Shipping Weight: 366 lb (166 kg)
- Warranty: One year parts and labor

**042-522** Radiation Shield, Mobile, Adjustable Height, Compact, 1" lead



### Mobile Radiation Shield

The Adjustable Height Mobile Radiation Shield puts shielding where it is needed. Roll into place, secure the wheels and adjust to the desired height. Panel can be height adjusted within a 4.5" range. Wheel and swivel locks on each caster provide secure placement.

#### Specifications:

- Dimensions:  
37.75" w x 29" depth x 40.5" h  
(95.9 x 73.7 x 102.9 cm)  
Shield: 36" w x 19" h (91.4 x 48.3 cm)  
Height Adjustable: 36" to 40.5"  
(91.4 to 103 cm)
- Lead Shielding: 1" thick (2.5 cm)
- Finish: Powder coat
- Weight: 446 lb (202.3 kg)
- Shipping Weight: 560 lb (254 kg)
- Warranty: One year parts and labor

**042-519** Radiation Shield, Mobile, Adjustable Height, 1" lead



### Steel Table

Sturdy as they come, this steel table can be used for just about any application requiring a strong, level platform. Ideal for holding heavy L-Block shields and caves, the surface is powder coated and the front legs feature adjustable levelers. Use the middle shelf to hold small items and the bottom shelf to support shipping containers or other large objects.

#### Features:

- Strong and sturdy
- Ideal for L-Block Shields and Lead Brick Caves
- Use in PET, nuclear medicine or radiation therapy departments
- Upper and lower shelf to accommodate small and large items, including PET shipping containers

#### Specifications:

- Dimensions: 36.75" w x 24" depth x 36" h  
(93.5 x 61 x 91.5 cm)
- Front legs incorporate adjustable levelers
- Finish: Powder coat
- Weight Capacity: 1550 lb (730 kg)
- Weight: 200 lb (90.9 kg)
- Shipping Weight: 254 lb (116 kg)

**042-407** Table, Steel

## Shielding & Storage



### Radiation Resistant Gloves

*Designed to reduce scattered beam radiation exposure in any fluoroscopic procedure*

Attenuating Gloves are designed to reduce scattered beam radiation exposure in any fluoroscopic procedure. At a nominal 9 mils in thickness, Attenuating Gloves offer excellent flexibility, dexterity, and tactile sensitivity. The thinness also helps reduce finger fatigue. Composed of a lead-free, latex-free, powder-free, Synthetic Neoprene Rubber and Bismuth Trioxide.

The gloves are sterile and offer the following direct attenuation rates.  
 57% at 60 kVp  
 47% at 80 kVp  
 40% at 100 kVp

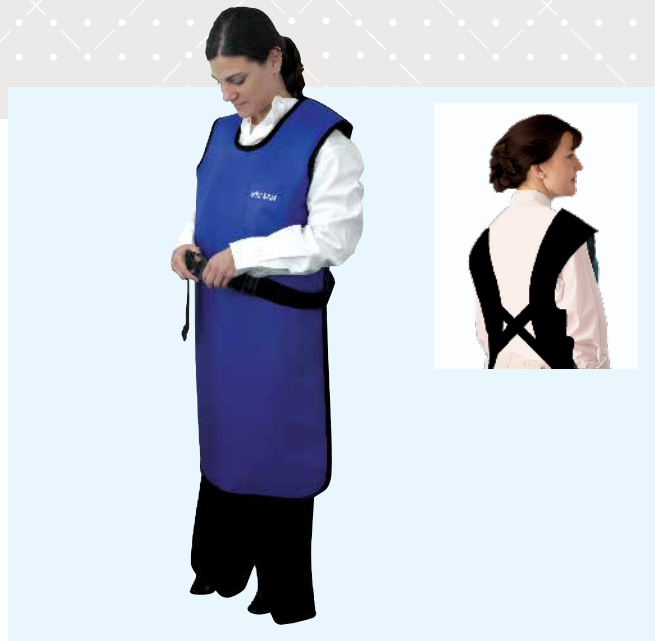

### Sof-Skin Coat Apron

This comfortable, supple, protective apron is a pleasure to wear. The lead vinyl core is totally sealed in a tough, easy-to-clean, chemical, abrasion and aging resistant outer covering that is more pliable and lighter than standard lead rubber aprons.

The apron design differs from conventional aprons. There are no straps or buckles for support. Instead the apron is supported across the breadth of the shoulders, held snugly in any position the wearer assumes with the closures. The contour conforming principles assure the wearer of comfort and protection at all times.

#### Specifications:

- Dimensions: 36" l x 24" w (91.4 x 61 cm)
- Lead Equivalency: 0.5 mm
- Color: Royal Blue (09)
- Weight: 10 lb (4.6 kg)

**0680-0017** Radiation Resistant Gloves, size 8

**103-701** Apron, Sof-Skin Coat  
**0680-0013** Thyroid Collar (Removable)

# Customize Your Lab for Safety and Efficiency

## Lead-Lined Laboratory Furniture

### **Versatile. Safe. Modular. Secure.**

Designed specifically for practical, secure storage of radioactive inventory, the Lead-Lined Laboratory Furniture can be configured to meet your storage, decay and workbench requirements.

- Install units individually, or in any combination
- Cabinets support up to 1500 lbs.
- Fully encased in steel - no exposed lead
- Includes key-lock doors and brackets for seismic anchoring



**CAPINTEC**  
A MIRION MEDICAL COMPANY

## LAB SUPPLIES

# Lead-Lined Cabinets & Enclosures

## Lead-Lined PET Unit Dose Cabinet

Designed for PET hot labs with limited space, the PET Unit Dose Cabinet provides a space-efficient work area over a fully shielded storage cabinet.

The cabinet requires the 042-433 Compact L-Block with Built-in Dose Calibrator Shield, the 039-412 Sharps Container Shield, the 042-434 Lead Brick Cave, and accommodates all of our Atomlab Dose Calibrators and many others. The dose calibrator display unit mounts on a stand above the countertop to maximize work space.

The lower cabinet has key-locking doors, two sliding bottom shelves, and two sliding upper shelves. The bottom shelves will accommodate PET shipping containers. The top shelves conveniently store syringes, syringe shields, and other small items. This cabinet is completely shielded on all six sides with .25", .5" and 1" lead, and can stand alone or be grouped with other cabinets.

All cabinets in this product line are built to the industry standard height of 36.5". All units include a stainless steel countertop incorporating a 0.5" lip and 4" backsplash. When ordering multiple units for grouped configuration, a unified countertop may be ordered to provide a continuous work surface.

Upon request, we will factory mount\* the L-Block and Sharps Shield in place eliminating the need for on-site lifting equipment. A simple pallet jack is all that is required to move the unit.

### Features:

- Designed for PET hot labs with limited space
- Accommodates:
  - Compact L-Block Shield with Built-in Dose Calibrator Shield
  - PET Sharps Container Shield
  - Lead Brick Cave
  - CRC® Dose Calibrators and most others
- Sliding shelves for:
  - PET shipping containers
  - Small items
- Lead shielded on all six sides
- Key-locked doors

### Specifications:

- Dimensions: 36.5" w x 24" depth x 36.5" h (93 x 61 x 93 cm)
- Lead Shielding: .25" thick (.64 cm)
- Finish: Powder coat
- Doors: Key-locked
- Countertop: Stainless steel with 4" (10.2 cm) backsplash and .5" (1.3 cm) lip
- Weight Capacity: 1550 lb (703 kg)
- Weight: 1240 lb (562 kg)

\*Offer applies to the Continental United States only.



- 244-200** Cabinet, PET, Unit Dose, .25" lead  
*Does not accommodate Lead Brick Cave*
- 244-205** Cabinet, PET, Unit Dose, .25" lead  
*Accommodates Lead Brick Cave 042-434*

### Related:

- 042-433** L-Block Shield, Compact, 1.5" lead  
*With built-in Dose Calibrator Shield*
- 042-434** Lead Brick Cave, 3-wall, 2" lead  
*Fits 042-433 L-Block Shield.*
- 5130-3235** CRC®-55t PET Dose Calibrator
- 0660-0042** PET Sharps Inserts  
*Fits 5730-2271*
- 5730-2271** PET Sharps Container Shield

*Note: The cabinet is also available with .5" and 1" lead shielding. Call for quote.*

## Lead-Lined Cabinets & Enclosures



### Lead-Lined Radioisotope Storage Cabinet

The Radioisotope Storage Cabinet is designed for safely storing radioactive materials. It features 12 key-locked drawers. Each drawer is easily removed for cleaning or decontamination. A card slot identifies contents.

**Specifications:**

- Dimensions: 30.5" w x 24" depth x 36.5" h (77.5 x 61 x 92.7 cm)
- Lead Shielding: .25" (.64 cm), .5" (1.3 cm) or 1" (2.5 cm) thick on all six sides
- Drawer Dimensions: I.D.: 6" w x 11.88" depth x 4.5" h (15.2 x 30.2 x 11.4 cm)
- Drawers: Key-locked
- Countertop: Stainless steel with 4" (10.2 cm) backsplash and .5" (1.3 cm) spillproof lip
- Finish: Powder coat
- Weight:
  - 244-110: 1069 lb (486 kg)
  - 244-111: 1415 lb (642 kg)
  - 244-112: 2558 lb (1160 kg)



### Lead-Lined Decay Cabinet

The Decay Cabinet is designed for long and short-term storage of decaying radioactive material. Two adjustable shelves support up to 100 lb each. The door is key-locked to prevent unauthorized access. The cabinet will accommodate sharps containers and other boxed waste prior to disposal. It can also be used to store flood sources.

**Specifications:**

- Dimensions: 30.5" w x 24" depth x 36.5" h (77.5 x 61 x 92.7 cm)
- Lead Shielding: .25" (.64 cm), .5" (1.3 cm) or 1" (2.5 cm) thick on all six sides
- Shelf Dimensions: 24.25" w x 18" depth (61.5 x 45.7 cm), 100 lb (45.4 kg) capacity, adjustable height
- Door: Key-locked
- Countertop: Stainless steel with 4" (10.2 cm) backsplash and .5" (1.3 cm) spillproof lip
- Finish: Powder coat
- Weight:
  - 244-140: 1010 lb (458 kg)
  - 244-141: 1267 lb (575 kg)
  - 244-142: 2125 lb (964 kg)

LEAD-LINED CABINETS & ENCLOSURES

**244-111** Cabinet, Radioisotope Storage, .5" lead  
**244-112** Cabinet, Radioisotope Storage, 1" lead

**244-141** Cabinet, Decay, .5" lead  
**244-142** Cabinet, Decay, 1" lead

*Note: Reverse door swing available.  
 Call for quote.*



## Lead-Lined Cabinets & Enclosures



Adjustable 12" shield can fold forward to load large objects. The hood can also be completely closed and used for storage. Preparation Enclosure features built-in electrical outlets.

### Lead-Lined Preparation Enclosure Base Cabinet

This Cabinet is designed to support the Lead-Lined Preparation Enclosure. Full height, overlapping double doors with key locks open to an adjustable shelf with a 100 lb capacity. The cabinet may be used for decay and storage.

#### Specifications:

- Dimensions: 36.5" w x 24" depth x 36.5" h (92.7 x 61 x 92.7 cm)
- Lead Shielding: .25" (.64 cm), .5" (1.3 cm) or 1" (2.5 cm) thick on all six sides
- Shelf Dimensions: 30" w x 18" depth (76.2 x 45.72 cm), 100 lb (45.4 kg) capacity, adjustable height
- Doors: Key-locked
- Countertop: Stainless steel with 4" (10.2 cm) backsplash and .5" (1.3 cm) spillproof lip
- Finish: Powder coat
- Weight:  
244-191: 1540 lb (699 kg)  
244-192: 2433 lb (1104 kg)

### Lead-Lined Preparation Enclosure

The Lead-Lined Preparation Enclosure is designed for applications that require handling gaseous radioactive materials. The interior provides ample floor space. A large lead glass window and halogen light allow safe and unobstructed viewing. The enclosure opening has an adjustable shield that creates access ports. A swing down shield covers the ports when not in use.

Gaseous materials are directed by a baffle (eliminating dead space) through a stainless steel chimney. The chimney is connected to external blowers (not supplied) and ductwork (not supplied). The blowers create a negative pressure preventing gas leaks.

#### Specifications:

- Dimensions: 36" w x 24" depth x 30.5" h (91.4 x 61 x 77.5 cm)  
Interior Floor Space: 31" w x 19" depth (78.7 x 48.3 cm)
- Lead Shielding: .25" thick (.64 cm)
- Adjustable Shield: 12" w x 10" h x .5" thick (30.5 x 25.4 x 1.3 cm)
- Exhaust: 6" dia (15.2 cm) chimney, fixed upper and adjustable lower baffles. Blower and filter not included
- Lighting: Halogen lamp with two 25 watt bulbs, UL listed.
- Lead Glass Window:  
Dimensions: 34.5" w x 11.8" h x .75" thick (87.6 x 30 x 1.9 cm)  
Density: 5.05 g/cm<sup>3</sup>
- Finish: # 3 brushed, stainless steel
- Weight: 733 lb (332 kg)

**244-191** Cabinet, Preparation Enclosure Base, .5" lead  
**244-192** Cabinet, Preparation Enclosure Base, 1" lead

**Related:**  
**244-007** Preparation Enclosure, .25" lead, 115 V

**244-007** Preparation Enclosure, .25" lead, 115 V  
**244-008** Preparation Enclosure, .25" lead, 230 V

**Related:**  
**244-191** Cabinet, Preparation Enclosure Base, .5" lead  
**244-192** Cabinet, Preparation Enclosure Base, 1" lead



## Lead-Lined Cabinets & Enclosures



### Lead-Lined Decay and Storage Cabinet

The Decay and Storage Cabinet performs two functions. Radioisotopes can be safely stored in drawers, while the cupboard section is for the storage of decaying material.

Drawers are easily removed for cleaning and decontamination. The decay section includes two heavy duty adjustable shelves.

#### Specifications:

- Dimensions: 36.5" w x 24" depth x 36.5" h (92.7 x 61 x 92.7 cm)
- Lead Shielding: .25" (.64 cm), .5" (1.3 cm) or 1" (2.5 cm) thick on all six sides
- Drawer Dimensions: I.D.: 6" w x 11.88" depth x 4.5" h (15.2 x 30.2 x 11.4 cm)
- Shelf Dimensions: 22" w x 18" depth (55.9 x 45.7 cm)
- Door and Drawers: Key-locked
- Countertop: Stainless steel with 4" (10.2 cm) backsplash and .5" (1.3 cm) spillproof lip
- Finish: Powder coat
- Weight:
  - 244-160: 1103 lb (501.4 kg)
  - 244-161: 1421 lb (645 kg)
  - 244-162: 2500 lb (1134 kg)

**244-161** Cabinet, Decay and Storage, .5" lead  
**244-162** Cabinet, Decay and Storage, 1" lead



### Lead-Lined Waste Cabinet

The Waste Cabinet is designed for storing "non-sharps" radioactive waste. A spacious chute with shielded cover allows waste to be dropped directly into a polyethylene container prior to decay and disposal.

#### Specifications:

- Dimensions: 30.5" w x 24" depth x 36.5" h (77.5 x 61 x 92.7 cm)
- Lead Shielding: .25" (.64 cm), .5" (1.3 cm) or 1" (2.5 cm) thick on all six sides
- Chute: 6.5" dia. (16.5 cm) with .5" thick (1.3 cm) lead shielded cover
- Container: 22" h x 17" dia. (56 x 43 cm) polyethylene, 16 gal capacity
- Door: Key-locked
- Countertop: Stainless steel with 4" (10.2 cm) backsplash and .5" (1.3 cm) spillproof lip
- Finish: Powder coat
- Weight:
  - 244-150: 913 lb (415 kg)
  - 244-151: 1282 lb (583 kg)
  - 244-152: 2290 lb (1039 kg)

**244-151** Cabinet, Waste, .5" lead  
**244-152** Cabinet, Waste, 1" lead

*Note: Reverse door swing available.  
 Call for quote.*

## Lead-Lined Cabinets & Enclosures



### Lead-Lined Waste and Storage Cabinet

The Waste and Storage Cabinet performs two functions. Radioisotopes can safely be stored in drawers, while the cupboard section is for the storage of "non-sharps" radioactive waste.

Drawers are easily removed for decontamination. The cupboard section includes a shielded port and a 16 gallon polyethylene container.

#### Specifications:

- Dimensions: 36.5" w x 24" depth x 36.5" h (92.7 x 61 x 92.7 cm)
- Lead Shielding: .25" (.64 cm), .5" (1.3 cm) or 1" (2.5 cm) thick on all six sides
- Drawer Dimensions: I.D.: 6" w x 11.88" depth x 4.5" h (15.2 x 30.2 x 11.4 cm)
- Waste Section:
  - Chute: 6.5" dia. (16.5 cm) with .5" thick (1.3 cm) lead shielded cover
  - Container: I.D.: 22" h x 17" dia. (56 x 43 cm) polyethylene, 16 gal capacity
- Door and Drawers: Key-locked
- Countertop: Stainless steel with 4" (10.2 cm) backsplash and .5" (1.3 cm) spillproof lip
- Finish: Powder coat
- Weight:
  - 244-170: 863 lb (391 kg)
  - 244-171: 1439 lb (653 kg)
  - 244-172: 2462 lb (1117 kg)

**244-171** Cabinet, Waste and Storage, .5" lead  
**244-172** Cabinet, Waste and Storage, 1" lead



### Lead-Lined Sink and Waste Cabinet

The Sink and Waste Cabinet performs three functions. A stainless steel sink allows the convenience of running water in the hot lab. The space under the sink is used for cold storage. Separated from the sink section by a lead barrier, the waste section includes a shielded port that allows waste to be dropped into a polyethylene container for storage until decayed.

#### Specifications:

- Dimensions: 30.5" w x 24" depth x 36.5" h (77.5 x 61 x 92.7 cm)
- Lead Shielding: .25" (.64 cm), .5" (1.3 cm) or 1" (2.5 cm) thick on all six sides
- Sink Section: 10" w x 14" depth x 10" h (25.4 x 35.6 x 25.4 cm) Integral stainless steel sink with gooseneck faucet and wrist blades; suitable for cold storage
- Waste Section:
  - Chute: 6.5" dia. (16.5 cm) with .5" thick (1.3 cm) lead shielded cover
  - Container: I.D.: 20.5" h x 11.25" dia. (52 x 28.6 cm), polyethylene, 7 gal capacity
- Door: Key-locked
- Countertop: Stainless steel with 4" (10.2 cm) backsplash and .5" (1.3 cm) spillproof lip
- Finish: Powder coat
- Weight:
  - 244-130: 849 lb (386 kg)
  - 244-131: 1253 lb (569.5 kg)
  - 244-132: 2260 lb (1027.3 kg)

**244-131** Cabinet, Sink and Waste, .5" lead  
**244-132** Cabinet, Sink and Waste, 1" lead

*Notes: Reverse door swing available.  
 Call for quote.*

## Lead-Lined Cabinets & Enclosures



Larger generator drawer will accommodate the Mallinckrodt Generator with Elution Shield.

### Lead-Lined Generator and Storage Cabinet

The Generator and Storage Cabinet provides hot lab radiation protection without hampering the elution process. The left drawer accommodates top or side loading generators. In addition to the .5" or 1" lead shielding in front, the drawer has .25" lead shielding on the remaining three sides and bottom. A removable drawer top allows generator replacement. Trap doors on the top and sides of this drawer provide safe access to the generator. The cabinet has two shielded compartments on the right side for storing decaying generators prior to disposal.

#### Specifications:

- Dimensions: 36.5" w x 24" depth x 36.5" h (92.7 x 61 x 92.7 cm)
- Lead Shielding:
  - Cabinet: .5" (1.3 cm) or 1" (2.5 cm) thick on all six sides
  - Drawer: .25" thick (.64 cm) on five sides
  - Dividers: .5" thick (1.3 cm)
- Drawer Dimensions: I.D.: 15.5" w x 11.9" depth x 18.2" h (39.4 x 30.2 x 46.2 cm)
- Doors and Drawer: Key-locked
- Countertop: Stainless steel with 4" (10.2 cm) backsplash and .5" (1.3 cm) spillproof lip
- Finish: Powder coat
- Weight:
  - 244-181: 1917 lb (869.5 kg)
  - 244-182: 2815 lb (1277 kg)

**244-181** Cabinet, Generator and Storage, .5" lead  
**244-182** Cabinet, Generator and Storage, 1" lead

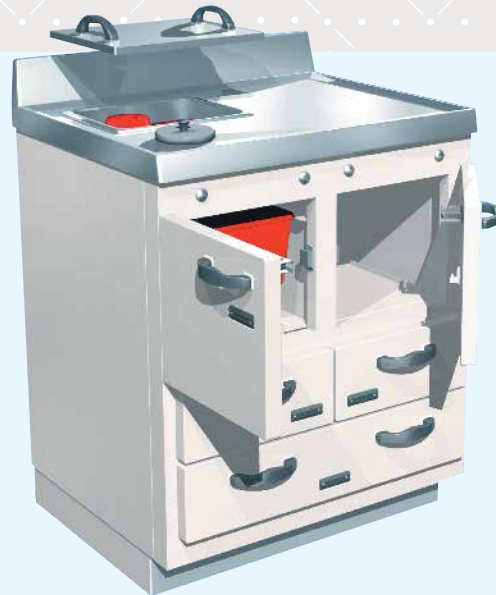

### Lead-Lined Unit Dose Cabinet

The Unit Dose Cabinet is designed for hot labs with limited space. The upper left compartment holds two sharps containers to facilitate decay rotation. Dispose syringes in the front container through a small chute. A large rear port allows safe removal of the second decayed container. Shielded doors on storage cabinets provide access to bulk unit dose ammo boxes without additional exposure. Side-by-side middle drawers can be used for storage of syringes, sources, pigs, radioisotopes and other small items requiring lead shielding.

Phantoms and flood sources can be stored in the bottom drawer which runs the full width of the cabinet.

#### Specifications:

- Dimensions: 30.5" w x 24" depth x 36.5" h (77.5 x 61 x 92.7 cm)
- Lead Shielding: .25" (.64 cm), .5" (1.3 cm) or 1" (2.5 cm) thick on all six sides
- Drawer Dimensions:
  - Bottom Drawer: I.D.: 23.5" w x 21.8" depth x 4.5" h (59.7 x 55.4 x 11.4 cm)
  - Left & Right Drawers: I.D.: 9.38" w x 17.88" depth x 4.5" h (23.8 x 45.4 x 11.4 cm)
  - Upper Doors: I.D.: 11.5" w x 17.62" depth x 11" h (29.2 x 44.7 x 27.9 cm)
- Doors and Drawers: Key-locked
- Countertop: Stainless steel with 4" (10.2 cm) backsplash and .5" (1.3 cm) spillproof lip
- Finish: Powder coat
- Weight:
  - 244-120: 1156 lb (524.3 kg)
  - 244-121: 1614 lb (732 kg)
  - 244-122: 2328 lb (1056 kg)

**244-121** Cabinet, Unit Dose, .5" lead  
**244-122** Cabinet, Unit Dose, 1" lead

## Lead-Lined Cabinets & Enclosures



Shown with Decay Module



Freestanding or under-the-counter unit



### Lead-Lined Phantom Cabinet

The Phantom Cabinet stores flood sources and phantoms\* on their ends. The interior is sectioned by an adjustable divider. The Lead-Lined Phantom Cabinet cannot be ordered separately, it must be part of a multiple cabinet configuration.

#### Specifications:

- Dimensions: 11.6" w x 24" depth x 36" h (29.5 x 60.9 x 91.4 cm)
- Lead Shielding: .25" thick (.64 cm)
- Door: Key-locked
- Finish: Powder coat
- Weight: 319 lb (145 kg)

\*Phantom Cabinet does not accommodate 24" circular phantoms.

**244-009** Cabinet, Phantom, .25" lead

Note: Must be ordered as part of a multiple cabinet configuration

### Lead-Lined Refrigerator

Our 5.3 cubic foot capacity Lead-Lined Refrigerator is ideal for storing radiopharmaceuticals, tagged biologicals and other radioactive materials. The two adjustable stainless steel shelves allow you to make the most of your refrigerator capacity.

#### Features:

- Touch pad digital controls
- 5.3 cubic foot capacity
- Automatic defrost
- Energy Star qualified – saves energy, money and natural resources
- Two adjustable stainless steel shelves

#### Specifications:

- Dimensions: 24.18" w x 25.5" depth x 34.25" h (61 x 64.8 x 87 cm)
- Lead Shielding: .125" thick (.32 cm)
- Capacity: 5.3 cu ft
- Door: Key-locked
- Power:
  - 244-004: 120V, 60 Hz, 1.1 amps
  - 244-005: 230V, 50 Hz, 1.2 amps
- Finish: Powder coat
- Weight: 340 lb (154.5 kg)
- Shipping Weight: 390 lb (177.2 kg)
- Warranty: One year parts and labor

**244-004** Refrigerator, Lead-Lined, 120 V

**244-005** Refrigerator, Lead-Lined, 230 V

Drawing can be accessed at [www.capintec.com](http://www.capintec.com)

## Lead-Lined Cabinets & Enclosures



### Lead-Lined Storage Safe

Conveniently loaded from the front, this Storage Safe is ideal for storing large quantities of high-activity radioisotopes. Shielded with a thickness of 2" of lead, the safe is encased in a powder-coated steel jacket and features an adjustable shelf.

The lead-lined door is hung with heavy duty non-sagging hinges and is key-locked to prevent unauthorized access.

Transporting this half-ton safe is made easier with the built-in lifting handles for use with a hoist or other means.

#### Specifications:

- Dimensions: 17.4" w x 17" depth x 19" h (44.2 x 43.2 x 48.3 cm)  
I.D.: 12" w x 12" depth x 12" h (30.5 x 30.5 x 30.5 cm)
- Lead Shielding: 2" thick (5 cm)
- Finish: Powder coat
- Door: Key-locked
- Weight: 1050 lb (476 kg)

**244-006** Safe, Storage, 2" lead

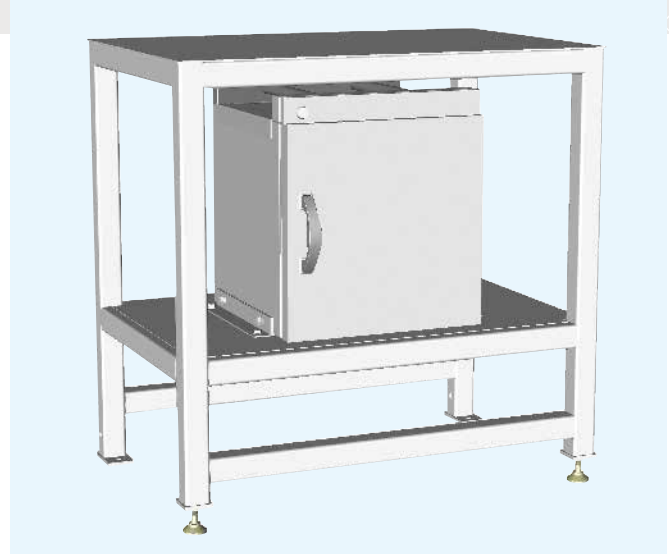

### Cyclotron Workbench

This steel table can be used for just about any application requiring a strong, level platform. Ideal for holding heavy L-Block shields and coves, the surface is powder coated and the front legs feature adjustable levelers. The middle shelf features a storage safe that is ideal for storing large quantities of high-energy radioisotopes and/or target decay. Shielded with a thickness of 2" of lead. The safe is encased in a powder-coated steel jacket and features an adjustable shelf. The lead-lined door is hung with heavy duty non-sagging hinges and is key-locked to prevent unauthorized access.

#### Features:

- Includes 2" lead storage safe
- Ideal for target decay
- Use in PET, nuclear medicine or radiation therapy departments

#### Specifications:

##### 042-456 Cyclotron Workbench

- Dimensions: 36.75" w x 24" depth x 36" h (93.5 x 61 x 91.5 cm)
- Front legs incorporate adjustable levelers
- Finish: Powder coat
- Weight Capacity: 1600 lb (725.76 kg) includes 1050 lb for safe
- Weight: 1200 lb (544.32 kg)
- Shipping Weight: 1250 lb (567 kg)

##### 244-006 Lead Storage Safe, 2"

- Dimensions: 17.4" w x 17" depth x 19" h (44.2 x 43.2 x 48.3 cm)  
I.D.: 12" w x 12" depth x 12" h (30.5 x 30.5 x 30.5 cm)
- Lead Shielding: 2" thick (5 cm)
- Finish: Powder coat
- Door: Key-locked
- Weight: 1050 lb (476 kg)

**042-456** Workbench, Cyclotron  
Includes: Storage Safe, 2" lead (244-006)



## Lead-Lined Cabinets & Enclosures

### PET Unit Dose Table

Designed for PET hot labs with limited space, the PET Unit Dose Table includes features to help maximize the work area and the protection.

The compact L-Block with dose calibrator shield features a large 8" x 8" x 4" lead glass window with adjustable window angle, 1.5" thickness lead shielding in front, and 1" thick lead in the base and in the chamber shield. It is designed to accommodate a chamber that is through mounted in the countertop. The chamber shield accommodates Atomlab chambers and many others.

The Sharps Container Shield is constructed of steel and lined with 1" thick lead. It features a lockable sliding cover for container removal and a hinged top door for syringe disposal.

Shipped completely assembled\*, the Unit Dose Table eliminates the need for on-site lifting equipment. A simple pallet jack is all that is required to move the unit. Once the dose calibrator chamber is placed in the shield, the chamber support shelf provides 1" thick lead shielding. The dose calibrator display unit mounts on a stand above the countertop to further maximize work space.

A spacious bottom shelf can hold several PET shipping containers. The middle shelf provides convenient storage for syringe shields and other small items.

In applications where additional shielding is required, the optional 042-434 Lead Brick Cave is available.

#### Features:

- Designed for PET hot labs with limited space
- Lead shielding under calibration chamber
- Shipped Completely Assembled:
  - Compact L-Block Shield with Built-in Dose Calibrator Shield
  - PET Sharps Container Shield
- Shelf space for:
  - PET shipping containers
  - Small items

\*Offer applies to Continental United States only



#### Specifications:

##### 042-448 PET Unit Dose Table:

- Dimensions: 36.75" w x 24" depth x 36" h (93.5 x 61 x 91.5 cm)  
Front legs incorporate adjustable levelers.
- Lead Shielding: 1" thick (enclosed in chamber mounting shelf)
- Finish: Powder coat
- Weight Capacity: 1550 lb (703 kg)
- Weight: 294 lb (133.3 kg)

##### 042-433 Compact L-Block with Dose Calibrator Shield:

- Dimensions: 18" w x 21.5" depth x 26" h (45.7 x 54.6 x 66 cm)
- Lead Shielding:
  - Front: 1.5" thick (3.8 cm)
  - Base: 1" thick (2.5 cm)
  - Calibrator Shield: 1" thick (2.5 cm)
- Calibrator Shield Inside Dimensions: 6.85" I. D. x 10.25" h (17.4 x 26 cm)
- Lead Glass Window:
  - Dimensions: 8" w x 8" h x 4" thick (20.3 x 20.3 x 10.2 cm)
  - Density: 5.2 g/cm<sup>3</sup>
- Finish: Powder coat
- Weight: 590 lb (259 kg)

**042-448** Table, PET, Unit Dose  
Includes: 042-433 Compact L-Block with  
Dose Calibration Shield and  
5730-2271 Sharps Container Shield

**Related:**  
**042-434** Lead Brick Cave, 3-wall, 2" lead  
Fits 042-433 L-Block Shield

**5130-2216** CRC®-55tW Dose Calibrator

**0660-0042** PET Sharps Inserts  
Fits 5730-2271



## LAB SUPPLIES

## Sources &amp; Markers

**FeatherLite™ Cobalt-57 Flood Source\***

*Improve quality control with superior camera calibration*

The FeatherLite Cobalt-57 Rectangular Flood Source weighs up to 60% less than other flood sources. Lower weight means less strain to the back and greater maneuverability. This flood source provides a uniform field of radiation for evaluation of nuclear medicine gamma camera performance, allowing detection and correction of any camera malfunction prior to diagnostic use. The typical useful life of the Co-57 Flood Source is approximately two years. The Co-57 Flood Source meets the standards established by the manufacturers of the gamma cameras.

The flood source is shipped with a lead-lined cardboard container. An optional case is available for the FeatherLite Flood Source.

**Features:**

- Environmentally safe
- Proprietary Cobalt chemistry
- Delivers superior source uniformity
- Technological innovation

**Specifications:**

043-861

- Dimensions: 25.2" l x 17.9" w (64 x 45.5 cm)
- Active Dimensions: 23.9" l x 16.4" w (60.7 x 41.6 cm)

**Specifications:**

0975-8400

- Active Dimensions: 23.9" l x 16.4" w (60 x 41.6 cm)

**043-861** Flood Source, Rectangular, 10 mCi  
Not available for export.



Radshield case and  
Radscooter sold  
separately.

**RadLite™ Cobalt-57 Flood Sources\***

The RadLite Cobalt-57 Flood Source is used to test the response uniformity of gamma cameras to ensure camera response is consistent over the total head area(s). Cobalt-57 is uniformly dispersed in an epoxy matrix fully sealed in a high integrity ABS encapsulation. Radionuclide purity is greater than 99.9% (combined Co-56/Co-58 is less than 0.08% at source reference date). The flood sources are supplied with a uniformity test statement, wipe test certificate, handling and storage information and a custom decay calendar.

**Features:**

- Lightweight, slim design
- Dual head quality control acquisition
- Expiration life up to 24 months

**Specifications:**

Rectangular Flood Sources

- Dimensions: 24.1" l x 16.7" w x .3" thick (61.2 x 42.4 x .76 cm)
- Active Dimensions: 23.9" l x 16.5" w (61 x 42 cm)

Cardiac Rectangular Flood Source

- Dimensions: 15.8" l x 9.5" w x .3" thick (40.1 x 24.1 x .76 cm)
- Active Dimensions: 15.5" l x 9.25" w (39.4 x 23.5 cm)

**043-840** Flood Source, Rectangular, 10 mCi  
**043-845** Flood Source, Rectangular, 20 mCi  
**043-860** Flood Source, Cardiac, Rectangular, 10 mCi  
Not available for export.

\*A photocopy of your NRC or Agreement State License must accompany orders for radioactive sources and must clearly indicate your authority to possess the source being ordered.

## Sources & Markers



### Reference Standards

*Guaranteed accuracy, highest quality and lowest cost in industry*

Each "E"-vial reference source comes with a certificate of radioactivity calibration that guarantees accuracy within 5%. If you need a reference source with an activity not listed in this catalog, Capintec can meet your special request promptly. Capintec will arrange for disposal of original source with purchase of replacement source.

#### Features:

- High-quality sources
- Lowest cost (available)
- Guaranteed accuracy within 5%
- Ensures that your dose calibrator meets NRC/Agreement State QC requirements
- Daily 18-month decay calendar
- Purchase individually or in sets
- Return policy eliminates expense of disposal

<b>0975-0006</b>	Reference Standards, Co-57 vial, 5 mCi
<b>0975-5710</b>	Reference Standards, Co-57 vial, 10 mCi
<b>0975-0002</b>	Reference Standards, Cs-137 vial, 100 µCi
<b>0975-3720</b>	Reference Standards, Cs-137 vial, 200 µCi
<b>0975-3725</b>	Reference Standards, Cs-137 vial, 250 µCi
<b>0975-0003</b>	Reference Standards, Ba-133 vial, 250 µCi
<b>0975-0008</b>	Reference Source Set, Co-57 (5 mCi), Co-60 (100 µCi), Cs-137 (200 µCi), Ba-133 (250 µCi)



### Dose Calibrator Syringe Vial Reference Sources\*

The daily calibration of dose calibrators is recommended to ensure accurate and reproducible instrument response. Calibration is easily achieved and maintained by the use of long-lived reference sources. These sources are solid cast epoxy, 20 ml active volume in the 27 ml Vial E. They are calibrated with  $\pm 5\%$  accuracy at the 99% confidence level, NIST traceable. Dose Calibrator Reference Sources are registered with the U.S. Food and Drug Administration Center for Devices and Radiological Health and the U.S. Nuclear Regulatory Commission. Each source includes a certificate of calibration, a leak test certificate, and a radiation safety and handling sheet. The source is packaged in an individual lead shield that is color coded and vinyl covered to eliminate exposure to the lead. Dose Calibrator Reference Sources are available individually or as an economical set.

*\*A photocopy of your NRC or Agreement State License must accompany orders for radioactive sources and must clearly indicate your authority to possess the source being ordered.*

<i>All sources calibrated to <math>\pm 5\%</math></i>	
<b>063-562</b>	Source, Ba-133, 250 µCi
<b>101-356</b>	Source, Cs-137, 200 µCi
<b>063-261</b>	Source, Co-57 simulated Tc-99m, 5 mCi
<b>063-720</b>	Source, Co-57 simulated Tc-99m, 10 mCi
<b>063-586</b>	Reference Source Set
	<i>Set includes: Co-57, 5 mCi; Cs-137, 200 µCi; Ba-133, 250 µCi</i>

*Not available for export.*

## Sources &amp; Markers



### Dose Calibrator Syringe Reference Sources\*

Dose calibration, should be performed in a manner that most closely represents how you use your dose calibrator. The Syringe Reference Source was designed for imaging facilities that obtain their radiopharmaceuticals in unit dose syringes. The sources are solid cast epoxy, 3 ml active volume in a 5 cc mock syringe. They are calibrated within  $\pm 5\%$  accuracy at 99% confidence level, NIST traceable. Each source includes a certificate of calibration, leak test certificate, and radiation safety and handling sheet. The source is packaged in an individual lead shield that is color coded to the source.

*\*A photocopy of your NRC or Agreement State License must accompany orders for radioactive sources and must clearly indicate your authority to possess the source being ordered.*

All sources calibrated to  $\pm 5\%$   
**063-362** Source, Co-57, 5 mCi  
 Not available for export.



### Check Source\*

Instrument functionality is easily assessed with a Cs-137 Check Source. The activity is 10  $\mu\text{Ci}$ . A license is necessary.

#### Specifications:

- Dimensions: 1" dia. x .25" thick (2.5 x .64 cm)

*\*A photocopy of your NRC or Agreement State License must accompany orders for radioactive sources and must clearly indicate your authority to possess the source being ordered.*

**101-103** Check Source, Cs-137,  
 10  $\mu\text{Ci}$  (uncalibrated)  
 Not available for export.

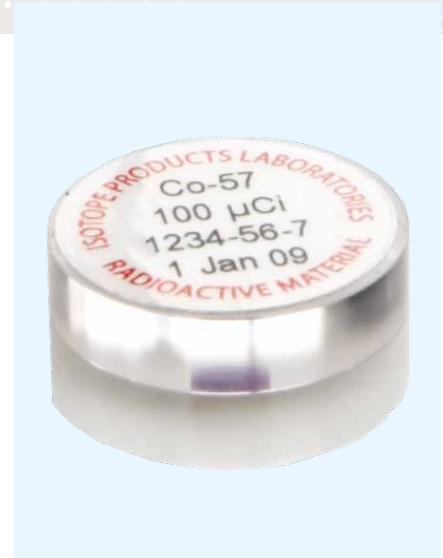

### Disk Source

Disk Sources are mainly used for checking the performance of GM tubes and NaI detectors. The disk is manufactured of high-strength plastic. The active area is centered in the disk.

#### Specifications:

- Dimensions: 1" dia. x .25" thick (2.5 x .64 cm)
- Active Diameter: 0.197" (5.0 cm)

**0975-139X** Cs-137 Disk,  
 0.37 MBq, 10  $\mu\text{Ci}$

## Sources & Markers

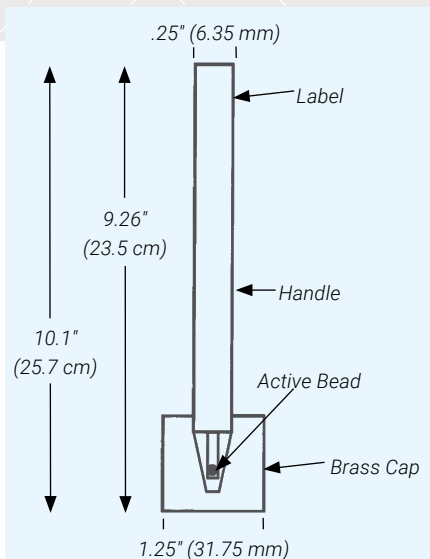

### Pen Point Marker Sources\*

The Pen Point Marker Source contains Co-57 in a ceramic matrix at the end of a 9.26" (23.5 cm) anodized aluminium rod. The pen-shaped rod screws into a brass cap which shields the active point. The Pen Point Marker Source is used in tracing the outlines of anatomical features on a patient. The trace appears almost instantly on the camera display. Contained activity is supplied as a nominal value  $\pm 15\%$ .

#### Specifications:

- Dimensions: 9.26" l x .25" dia. (235 x 6.35 mm)
- Nuclide: Co-57
- Source: 2 mm bead
- Nominal Activity:  
063-700 100  $\mu\text{Ci}$   
063-701 200  $\mu\text{Ci}$
- Source Cover: Brass cap

**063-700** Marker Source, Pen Point, 100  $\mu\text{Ci}$   
**063-701** Marker Source, Pen Point, 200  $\mu\text{Ci}$   
*Not available for export.*

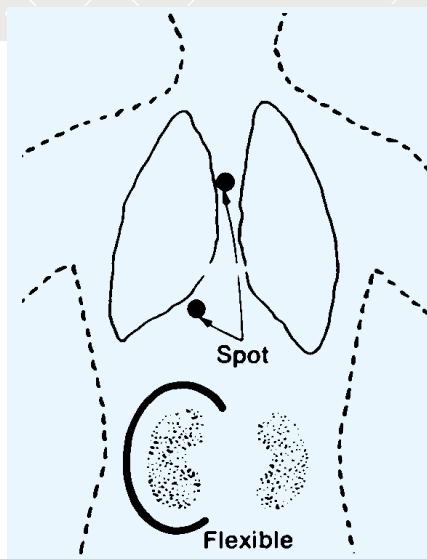

### Spot Marker Source\*

A Spot Marker Source is easily taped to the patient for purposes of orientation while performing a camera study.

#### Specifications:

- Dimensions: 1" dia. x .25" thick (25 x 6 mm) clear lucite disk
- Spot: .125" dia. (3 mm)
- Activity:  
099-289: 50  $\mu\text{Ci}$   
099-291: 100  $\mu\text{Ci}$   
0975-S050: 50  $\mu\text{Ci}$   
0975-S100: 100  $\mu\text{Ci}$   
0975-S200: 200  $\mu\text{Ci}$

**099-289** Marker Source, Spot, Co-57, 50  $\mu\text{Ci}$



### Fillable Point Marker Source

Marker Sources are easily filled with the same radionuclide to be used in imaging procedures. Small clear plastic receptacle, 1" diameter x .5" thick, has a centered channel to contain 0.2 cc of the nuclide. A nylon screw-plug tightens against an O-ring completing a tight, safe seal. Marker is re-usable or nuclide can be decayed or removed.

#### Specifications:

- Dimensions: 1" dia. x .5" thick
- Volume: 0.2 cc

**043-274** Marker Source, Fillable Point, 4/set

*\*A photocopy of your NRC or Agreement State License must accompany orders for radioactive sources and must clearly indicate your authority to possess the source being ordered.*

## Sources &amp; Markers



## Rod Sources

These sources are used for calibrating well type NaI detectors. They are constructed of high-strength plastic to withstand the rigors of constant use in a busy department. They have a flat base which allows easy positioning in the vertical position required for consistent accuracy in the counting of many tests.

Capintec Rod Sources are calibrated as NIST traceable with an accuracy of  $\pm 5\%$  at the 99% confidence level. Each source consists of a lucite rod measuring

### Specifications:

- Dimensions: 5" l x .5" w (12.7 x 1.27 cm)

### Lucite Rod

- Dimensions: 2.95" l x .5" w (7.4 x 1.27 cm)
- Active Diameter: 0.187" (9 mm)

### 0975-152R and 0975-137R

- Nominal Calibration +/-15%

### 0975-137S and 0975-0025

- Nominal Calibration +/-5%

**0975-152R** Rod Source, Eu-152, 0.5  $\mu$ Ci  
**0975-137R** Rod Source, Cs-137, 0.5  $\mu$ Ci  
**0975-0025** Rod Source, Co-57 37 kBq, 1.0  $\mu$ Ci

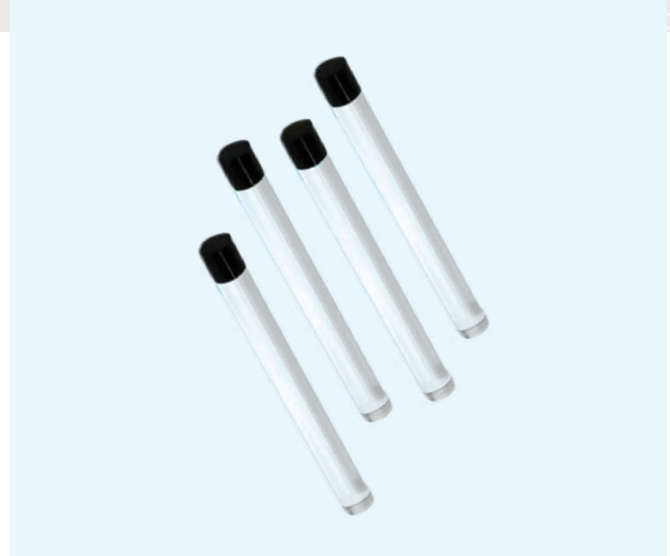

## Rod Sources\*

To calibrate well type scintillation crystals, we offer a variety of Rod Sources to meet department needs. You can count on consistent accuracy. Rod Sources are calibrated as NIST traceable with an accuracy of  $\pm 5\%$  at the 95% confidence level.

### Specifications:

- Dimensions: 2.96" l x 0.47" dia.  
(76 x 11.9 mm)
- Nominal Total Activity: 0.1  $\mu$ Ci

\*A photocopy of your NRC or Agreement State License must accompany orders for radioactive sources and must clearly indicate your authority to possess the source being ordered.

**063-140** Rod Source, Ge-68 simulated F-18  
 Not available for export.

LAB SUPPLIES

# Lab Equipment

LAB EQUIPMENT



*Convenient, adjustable and portable for safe injections; includes a Lead-Lined Multi-Syringe Holder for convenient radionuclide injections.*

## Injection Stand

The Injection Stand allows fast, comfortable arm positioning for radionuclide injections. The clear plastic armrest rotates 180° facilitating convenient angling while the cradle design holds the patient's arm firmly in place. A utility tray sits adjacent to the armrest to place various supplies and includes a shielded Multi-Syringe Holder, which accommodates up to four syringes.

The stand is height adjustable to accommodate patient comfort. Smooth rolling casters allow the stand to roll easily into position or out of the way for storage when not in use. The stand is structurally balanced to help prevent tipping.

**Specifications:**

- Height Adjustable: 29" h to 44" h (74 to 112 cm)
- Stand Base: 17.5 x 17.5 (44.5 x 44.5 cm)
- Construction: Stable, chrome plated tubular steel
- Shipping Weight: 21 lb (10 kg)



*Injection Chair features an easy to clean, one piece plastic drawer. Drawer and arm can be mounted on either side of the chair.*

## Injection Chair

Designed specifically for injections and blood drawing, this chair is a comfortable solution for patient seating and positioning. The flat surface of the armrest prevents backbending of the elbow and subsequent flattening of the vein. The armrest is height adjustable to accommodate all patient sizes with a knob adjustable double pivot swing arm. The seat itself is one piece of plastic which makes it easy to clean. A stiffener bias limits backrest flexibility to ensure stable seating.

**Specifications:**

- Dimensions: 23" l x 43" w (58.5 x 109 cm)
- Seat Dimensions: 16" l x 17" w x 20" h (40.6 x 43 x 51 cm)
- Arm Height (adjustable): 27" h to 33" h (69 to 84 cm)
- Width between arms: 20" (51 cm)
- Construction (frame): Heavy steel tubing 1.25" (3 cm) square, with chromed steel uprights for stability
- Weight: 35 lb (15.9 kg)
- Patient Weight Capacity: 250 lb (113.4 kg)

135-022 Stand, Injection

214-220 Chair, Injection with Storage Drawer





Chair back and arms fold away from imaging area with the touch of a button.

## Imaging Chair

The Imaging Chair puts the patient at ease and provides alternative patient positioning for nuclear medicine procedures. With the back support and armrests in place, the chair can swivel 360°. Once wheeled to the proper location, the chair can be anchored while the patient is seated by engaging the foot-operated wheel locks. The height of the chair can be increased from 41" to 48" by stepping on the foot pump arm. Hold the arm down and the chair slowly lowers to its minimum height. At the rear of the seat cushion is a locking handle which allows you to move the seat of the chair 4" to the left or right, while the base remains anchored. For lateral and posterior access, the back support and armrests drop out of the way with a simple tug of the corresponding pull pin. The wide armrest allows the Imaging Chair to double as an injection chair.

### Specifications:

- Dimensions: 24" w x 41" h (64 x 104 cm)  
Seat Dimensions: 17" w x 11" deep (43 x 28 cm)  
Height Adjustable: 19" h to 26" h (48 to 66 cm)  
Backrest: 19" above seat top (48 cm)
- Upholstery: 2" foam with gray vinyl cover
- Finish: Black baked enamel
- Wheels: Four locking swivel casters, 2" dia. (5 cm)
- Patient Capacity: 350 lb (159 kg)
- Weight: 75 lb (34 kg)
- Shipping Weight: 85 lb (38.5 kg)



## Injection/Resting Chair

*A comfortable rest between injection and imaging*

Most protocols require that prior to imaging, a patient rest for up to one hour after an injection of FDG F-18. Typical injection chairs are not designed for comfort, making rest difficult.

The Injection/Resting Chair is a comfortable resting spot for patients to wait between injection and imaging. The chair achieves three recline positions and features an infinitely adjustable back. For patient safety, deep recline and Trendelenburg positions can only be achieved by the attendant. A quick release handle that spans the entire width of chair back allows effortless position change from either side of the chair.

### Specifications:

- Dimensions: 35" w x 49" h (89 x 125 cm)  
Seat: 20" depth x 25" w x 21" h (51 x 64 x 53 cm)  
Back: 25" w x 34" h, above seat (64 x 86 cm)
- Upholstery: Blueridge, fire retardant
- Frame: Welded powder-coated steel
- Casters: Four 5" heavy-duty with positive locking swivel and wheel brakes
- Warranty: Five-year on frame
- Patient Capacity: 450 lb (204 kg)
- Weight: 116 lb (52.6 kg)

## Lab Equipment



### High Handle Foot Stool

This lightweight, yet durable stool is the safe and easy way for patients to get on or off examination tables. Steel construction assures long life. Rubber caps on the legs and a non-slip surface further assure stability and patient safety.

**Specifications:**

- Shipping Weight: 12 lb (5.5 kg)
- Patient Capacity: 250 lb (113.4 kg)

**214-728** Foot Stool, High Handle



### Niptongs

These low-cost tongs are used to handle small radioactive or otherwise dangerous objects up to 1" diameter. The tongs have a 45° v cut groove on each jaw. The compression spring maintains a strong grip on the object until the tension is released by squeezing the finger bar. Niptongs are made of chrome-plated, high carbon steel with hardwood handles and are easily disassembled for decontamination and cleaning.

**011-012** Niptongs, 12" (30 cm)  
**011-036** Niptongs, 36" (91 cm)



### CAP-TONGS

CAP-TONGS were designed for use in our own facility to pick up vials. We now offer this simple device to you for use in your lab. The CAP-TONGS are made of aluminum with rubber tips for a positive grip on the vial. Standard length is 9".

**0645-0022** CAP-TONG Forceps 9" (22.8 cm)

## Lab Equipment

**Forceps**

Surgical forceps are excellent handling devices for small items in the hot lab. No need to physically touch vials, ampules, etc. Forceps are made of surgical grade steel.

**066-536** Forceps, Curved, non-locking, 12.5" (31.7 cm)

**Forceps**

Surgical forceps are excellent handling devices for small items in the hot lab. No need to physically touch vials, ampules, etc. Forceps are made of surgical grade steel.

**0645-0025** Straight Forceps 9.5" (24.1 cm)  
**0645-0026** Curved Forceps 9.5" (24.1 cm)

**Radi-Clean Decontaminant**

This mild but powerful concentrate will safely remove radioactive contamination and problem substances from all types of lab apparatus. Radi-Clean cleaning power is comparable to a hot acid bath but with no hazard to personnel. At nominal dilution (1 to 50) with warm tap water, Radi-Clean Concentrate is negligibly corrosive, mildly alkaline, and harmless to skin and clothing. One liter makes 12 gallons of solution.

**0601-0003** Radi-Clean Decontaminant (1 liter)

## Lab Equipment



### Absorbent Paper

Protect any work surface with plastic lined Absorbent Paper. Spills and splashes are immediately contained without messy clean up. Available in pre-cut sheets or by the roll, Absorbent Paper is efficient for any work surface.

Together with the optional paper dispenser, the 300-foot Absorbent Paper Roll can be conveniently located to any wall or bench. It works like a common paper towel dispenser, yet is extra-strong to support the oversized 11 lb roll.

#### Specifications:

033-304 Absorbent Paper Rolls

- Dimensions: 300' l x 20" w (91.5 m x 51 cm)
- Shipping Weight: 33 lb (15.8 kg)

033-013 Absorbent Paper Sheets

- Dimensions: 17" l x 13" w (43 x 33 cm)

**033-304** Absorbent Paper, Rolls, 300 ft/roll, 2/pkg  
**033-013** Absorbent Paper, Sheets, 50/pkg

**Related:**  
**046-275** Dispenser, Disposable Protective Roll  
*For 033-304 Absorbent paper. Wall mounted.*



### Powder-Free Radiation Attenuating Gloves

Powder-Free Radiation Attenuating Gloves provide increased protection from direct X-ray beam and scattered radiation, and reduce harmful radiation exposure during any procedure requiring the use of fluoroscopy.

Just .007" thick, these gloves provide superior performance and dexterity over thicker, conventional radiation gloves. The reduced thickness allows for more flexibility and greater touch sensitivity while decreasing finger fatigue – all factors critical when working with delicate instruments. Applications include fluoroscopy, radioisotope handling, radiology and nuclear medicine.

Because these gloves are powder-free, lead-free and latex-free, they offer a reduced risk of natural rubber latex allergies and are an environmentally friendly alternative to leaded gloves.

Powder-Free Radiation Attenuating Gloves meet the following attenuation values:

- 58.7% attenuation at 60KVP HVL = 2.3 mm Al
- 49.9% attenuation at 80KVP HVL = 3.3 mm Al
- 44.6% attenuation at 100KVP HVL = 4.3 mm Al
- 40.6% attenuation at 120KVP HVL = 5.6 mm Al

All gloves are shipped sterile and ready to use in single pair packages.

**208-070** Gloves, size 7, pr 2  
**208-075** Gloves, size 7-1/2, pr  
**208-080** Gloves, size 8, pr  
**208-085** Gloves, size 8-1/2, pr



### Decontamination Kit

This kit contains all protective clothing, decontaminants and accessories for handling radioactive spills or other routine contamination problems in the lab. Each kit comes in a 13 gallon plastic drum with a radioactive label and can be used for storing radioactive waste.

#### Contents of Kit

Quantity	Item
1	13 Gal EZ-Stor Poly Container with Hinged Lid, White
1	Vinyl Label "Caution Radioactive Material"
2	Disposable Zipper Coveralls with Hood
2 pair	Disposable PVC Booties, Yellow, 6 Mil
2	Half Mask Respirators, 5500 Series, with P100 Hepa Filters
2 pair	Latex Anti-C Gloves
1	Bottle Decon Hand and Instrument Cleaner with Sprayer
5	Yellow Polyethylene "Rad" Bags, 18" x 24", .004 Mil
1	Roll Yellow Tape with Magenta Lettering, "Radioactive Material", with Radiation Symbol
1 each	Sponge Mop, Pail, Dustpan and Brush
2	Yellow Warning Signs with Magenta Lettering, "Caution Contaminated Area" with Radiation Symbol
1	Roll 3 Strand "Rad" Rope, 5/16" x 50', Yellow/Yellow/Magenta
1	Pack of 50 Test Wipe Smears
1	Disposable Tong

**0601-0019** Decontamination Kit, Complete



### Minor Emergency Spill Kit

The Capintec Minor Spill Emergency Kit is based on the suggested contents described in NRC Reg Guide. The Minor Spill Kit is better suited for use in the Nuclear Medicine area.

All kits include translucent yellow tint, 4 mil plastic liners to be stored for quick retrieval in the event of a contamination incident. The kit includes Emergency Procedures and forms to document a spill and decontamination efforts.

#### Contents of Kit

Quantity	Item
6 pr	Disposable Gloves
1 pr	Housekeeping Gloves
2 ea	Disposable Lab Coats
2 ea	Disposable Head Covers
2 pr	Disposable Shoe Covers
5 ea	Plastic Backed Absorbent Paper
1 roll	Roll Absorbent Paper with Plastic Backing
6 ea	Yellow Plastic Bag Liners with Twist Ties
1 roll	"Caution Radioactive" Tape
1 ea	Black Pen
1 ea	Pencil
3 ea	"Caution Radioactive Material" Pre-Strung Tags
10 ea	Contamination Smears Samples
1 ea	Clipboard with "Emergency Procedures" Instructions and Forms

**0601-0009** Minor Spill Emergency Kit



## Lab Equipment



### Tec-Control™ Chromatography Systems

#### Tec-Control Aluminum Breakthru Kit

The Aluminum Breakthru Kit provides a rapid, easy and inexpensive way to test aqueous solutions, particularly pertechnetate generator eluate, for trace quantities of aluminum. Aluminum forms an intense red precipitate with the indicator paper, and the intensity of the color is directly proportional to the amount of aluminum in the solution. The USP allows a concentration of aluminum ion in an injection  $\leq 10$  micrograms per milliliter (10  $\mu\text{g}/\text{ml}$ ) in technetium 99m eluate prepared from Molybdenum 99 formed as a result of uranium fission.

#### Simple Procedure:

1. Place a drop of the eluate or solution to be tested on the indicator paper. The best procedure is to form a hanging drop using a 19-22G needle.
2. Place a drop of the standard aluminum solution on the indicator paper. Use the same size drop.
3. Compare the intensity of the red spot formed. If the eluate spot is less intense than the standard solution, the eluate contains less than 10  $\mu\text{g}/\text{ml}$  aluminum.

#### References:

*Miniaturized Chromatographic Quality-Control Procedures for Tc-99m Radiopharmaceuticals*; A. Michael Zimmer and Dan G. Pavel, *Journal of Nuclear Medicine*, Vol. 18/12, Dec. 1977, pg. 1230.

*Technical Parameters Associated with Miniaturized Chromatography Systems*; Raimund A. Taukulis, A. Michael Zimmer, Dan G. Pavel and Bhupendra A. Patel, *University of Illinois Medical Center, Chicago, Illinois, Journal of Nuclear Medicine Technology*, Vol. 7/1.

- 150-780** Chromatography Kit, Tec-Control Aluminum Breakthru Kit includes: Aluminum standard, 5 ml, 10  $\mu\text{g}/\text{ml}$ , 50 indicator strips and manual
- 150-785** Chromatography Kit, Tec-Control Aluminum Breakthru Kit includes: Aluminum standard, 5 ml, 5  $\mu\text{g}/\text{ml}$ , 50 indicator strips and manual



#### Chromatography Strips and Solvents

Tec-Control Chromatography tests the radiochemical purity of specific Tc-99m-labeled radiopharmaceuticals. The accompanying chart shows which strips and solvents are required to perform each individual test. Some solvents must be purchased separately (see Sigma-Aldrich chart) due to hazardous material shipping restrictions. Detailed instruction manuals are packaged with each strip container, although our Radiopharmaceutical QC Procedure Manual (150-000) explains paper chromatography in greater detail.

#### Chromatography Strips

- 150-001** Strips, RED, 50/pkg  
**150-005** Strips, BLACK, 50/pkg  
**150-025** Strips, YELLOW, 50/pkg  
**150-122** Strips, ORANGE, 50/pkg  
**150-125** Strips, LIGHT BLUE, 50/pkg  
**150-126** Strips, BROWN, 50/pkg  
**150-127** Strips, GREEN, 50/pkg  
**150-130** Strips, GOLD, 50/pkg  
**150-771** Strips, DARK GREEN, 50/pkg  
**150-951** Strips, LIME, 50/pkg  
**150-952** Strips, PEACH, 50/pkg  
**150-971** Strips, TEAL, 50/pkg  
**150-991** Strips, PINK, 50/pkg  
**150-782** Strips, ALUMINUM, 50/pkg

#### Chromatography Solvents

- 150-160** Solvent, 20% Sodium Chloride, 30 ml  
**150-773** Solvent, DTPA, 5 ml  
**150-781** Solvent, Aluminum Standard, 5 ml, 10  $\mu\text{g}/\text{ml}$   
**150-783** Solvent, Aluminum Standard, 5 ml, 5  $\mu\text{g}/\text{ml}$

#### Related Items:

- 150-960** Developing Vials, Borosilicate Glass, 10 ml, 288/case (used for most Tec-Control testing)  
**150-961** Developing Vials, Borosilicate Glass, 5 ml, 144/case (used for Sestamibi & Tetrofosmin)  
**0645-0026** Forceps, Curved, locking, 9.5" l (24.1 cm)  
**0645-0025** Forceps, Straight, locking, 9.5" l (24.1 cm)  
**066-536** Forceps, Curved, non-locking, 12.5" l (31.7 cm)



## Chromatography QC for the Following Radiopharmaceuticals:

Radiopharmaceutical	Solvent(s) Required*	Strips Required
Aluminum Breakthru	150-781	150-782
Aluminum Breakthru	150-783	150-782
Bicisate (Neurolite™)	Ethyl Acetate 99.%	150-130
Diphosphonate	Acetone (HPLC Grade), Distilled H2O	150-001 & 150-005
Disofenin (Hepatolite™)	150-160, Distilled H2O	150-122 & 150-125
DMSA	Acetone (HPLC Grade),	150-025
DTPA	Acetone (HPLC Grade), Distilled H2O	150-001 & 150-005
Exametazine (Ceretek™)	Ethyl Acetate 99.%	150-130
Fluorodeoxyglucose (FDG)	Acetone (HPLC Grade)	150-127
Glucoheptonate	Acetone (HPLC Grade), Distilled H2O	150-001 & 150-005
HDP; HMDP and Octreoscan™ HDP	Acetone (HPLC Grade), Distilled H2O	150-001 & 150-126
MAA	Acetone (HPLC Grade),	150-001
MAG3 (Mertiatide™)	Acetone, (HPLC Grade), Chloroform 99.8% Tetrahydrofuran 99+%	150-951 & 150-952
MDP	Acetone (HPLC Grade), Distilled H2O	150-001 & 150-005
Mebrofenin (Cholotec™)	150-160, Distilled H2O	150-122 & 150-125
Pyrophosphate	Acetone (HPLC Grade), Distilled H2O	150-001 & 150-005
Sestamibi (Cardiolite™ and Miraluma™)	Ethyl Acetate 99.%	150-991
Sulphur Colloid	Acetone (HPLC Grade),	150-001
Tc-99m (reduced)	Acetone (HPLC Grade),	150-001
Tc-99m Monoclonal Antibodies	0.9% Saline	150-771
Tetrofosmin (Myoview™)	Ethyl Acetate 99.%	150-971
In-111 Octreotide (Octreoscan™)	150-773 & 0.9% Saline	150-771 **
In-111 Monoclonal Antibodies	150-773 & 0.9% Saline	150-771 **
In-111/Y-90 Zevalin™	0.9% Saline	150-772
I-131 Monoclonal Antibodies and Neutrospec™	0.9% Saline	150-771

\* See Sigma-Aldrich product matrix for solvents.

\*\* Note: A Well Plate is suggested to perform QC on these radiopharmaceuticals.

Tec-Control Solvent Vendor: Sigma-Aldrich Chemical Company 800-558-9160   www.sigmaaldrich.com	
<i>Note: Customers outside the US should visit the Sigma-Aldrich web site to locate a regional office.</i>	
Solvent Description	Vendor Part #
Acetone HPLC Grade	27072-5
Ethyl Acetate 99.5% ACS Reagent	31990-2
Chloroform 99.8% ACS Reagent	31998-8
Tetrahydrofuran 99+% ACS Reagent	36058-9

## Radiopharmaceutical QC Manual

This detailed manual explains Paper Chromatography, a QC method for evaluating the radiochemical purity of currently used Tc-99m-labeled radiopharmaceuticals. Procedures are quick and easy to use, a simple quality control solution for any nuclear medicine department.

**MINIATURIZED  
CHROMATOGRAPHY  
PROCEDURES FOR  
RADIOPHARMACEUTICALS:  
2011 UPDATE**  
150-000

BY  
A. MICHAEL ZIMMER, PhD

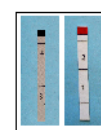
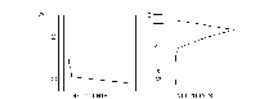

150-000 Procedure Manual, Radiopharmaceutical QC

## Lab Equipment

### HotPot™

Shielded dry heating block ideal for Tc-99m kit preparation

#### Features:

- Eliminates splashes from boiling water
- Digital temperature control
- Countdown timer with automatic shut off
- 4 mm lead shielding on all sides
- Heater range up to 160° C
- Durable powder coated steel housing
- Protective Teflon cover overheating element
- Four heating cavities to accommodate most common kit vials

#### Specifications:

- Temperature Setting Range: 5 °C - 160 °C (41 °F - 320 °F)
- Resolution: 1 °C (33.8 °F)
- Accuracy: +%5
- Operating Temperature: 5 °C - 40 °C (41 °F - 104 °F)
- Storage Temperature: 0 °C - 50 °C (0 °F - 122 °F)
- Power: 120 V/60 Hz or 220-240 V/50 Hz
- Weight: 14.3 lb (6.5 kg)

#### Physical

- 209 x 140 x 129 mm (8.2 x 5.5 x 5.1 in.)
- Shielding: 4 mm (.16 in.) lead

#### Kit and Vial Well Dimensions:

##### 220V V version

- Hole 1: 21 mm diameter x 49.5 mm deep (.83 x 1.95 in.)
- Hole 2: 24 mm diameter x 41.5 mm deep (.94 x 1.63 in.)
- Hole 3: 22.5 mm diameter x 45.5 mm deep (.89 x 1.79 in.)
- Hole 4: 26 mm diameter x 45.5 mm deep (1.02 x 1.79 in.)

##### 110V V version

- Hole 1: 25.5 mm diameter x 43 mm deep (1 x 1.7 in.)
- Hole 2: 22.6 mm diameter x 41 mm deep (.9 x 1.6 in.)
- Hole 3: 24.2 mm diameter x 27 mm deep (.95 x 1.1 in.)
- Hole 4: 24.2 mm diameter x 27 mm deep (.95 x 1.1 in.)

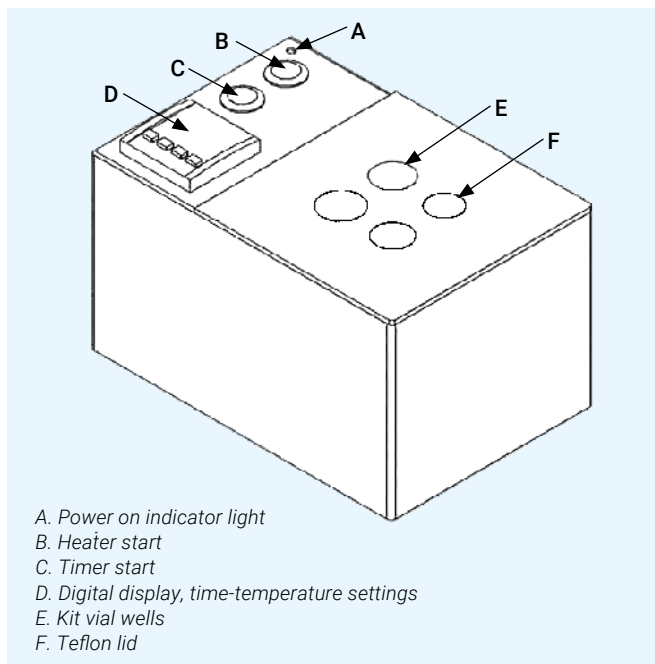

0651-0024 HotPot, 110 V  
 0651-0023 HotPot, 220 V

# Signs, Labels & Tags

Protect staff and visitors with convenient identification that conforms to government standards. Highly visible yellow labels and signage suggest caution where radioactive materials are present.

- Pressure Sensitive Shipping Labels
- Pre-Strung Tags
- Warning Tapes and Rope
- Radioactive Warning Labels
- Caution Signs



LAB SUPPLIES

# Signs, Labels & Tags



## Warning Rope

Made of high quality polypropylene, this triple strand rope assures high visibility and remarkable strength.

**Features:**

- Brightly colored - magenta and yellow
- Triple-strand strength



## Hazard Tape

Hazard Tape is a highly visible magenta and yellow warning tape that's perfect for identifying physical hazard areas and materials. Its an inexpensive compliance with OSHA's code for nuclear hazard. Constructed of 6 mil. vinyl, the tape is durable to withstand long-term placement. The tape will easily affix to any clean, smooth, dry surface.

**121-073** Rope, Warning, 100'/pkg  
.31" dia (.8 cm)  
Conveniently packaged in 100'  
(31 meters) lengths

**026-020** Tape, Hazard  
2" w x 108' l (5 cm x 33 m)

## Signs, Labels &amp; Tags



024-914

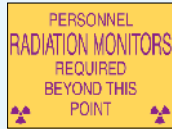

024-957



024-948



024-999



024-900



024-923



024-910

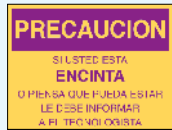

024-911

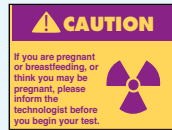

024-916



026-013

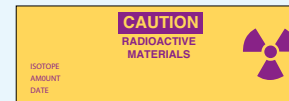

026-012



026-005

## Plastic Caution Signs

These signs convey the warning clearly. They are constructed of heavy-duty polyethylene with convenient holes for indoor or outdoor mounting.

<b>024-914</b>	Sign, Caution, Radiation Area 14" w x 10" h (35.6 x 25.4 cm)
<b>024-957</b>	Sign, Radiation Monitors Required 14" w x 10" h (35.6 x 25.4 cm)
<b>024-948</b>	Sign, Caution, Radioactive Materials 14" w x 10" h (35.6 x 25.4 cm)
<b>024-916</b>	Sign, Caution, If you are Pregnant or Breastfeeding 14" w x 10" h (35.6 x 25.4 cm)
<b>024-999</b>	Sign, Caution, Radioactive Materials 7" w x 10" h (17.8 x 25.4 cm)
<b>024-900</b>	Sign, Caution, Radiation Area 7" w x 10" h (17.8 x 25.4 cm)
<b>024-923</b>	Sign, Caution, X-Ray Caution 7" w x 10" h (17.8 x 25.4 cm)
<b>024-910</b>	Sign, Caution, If you are Pregnant 14" w x 10" h (35.6 x 25.4 cm)
<b>024-911</b>	Sign, Precaucion, Si usted esta Encinta Spanish version of 024-910 14" w x 10" h (35.6 x 25.4 cm)

## Perforated Warning Tapes

Pressure Sensitive adhesive plastic tapes stick to almost everything and are moisture resistant. All wording, symbols and colors conform to government regulations. Use ballpoint pen on tape labels for proper container identification. Continuous 180 ft. rolls.

<b>026-013</b>	Tape, Radioactive Material, 180 ft/roll 1" w x 3" l (2.5 x 8 cm)
<b>026-012</b>	Tape, Caution, Radioactive Materials, 180 ft/roll 1" w x 2" l (2.5 x 5 cm)
<b>026-005</b>	Tape, Caution, Radioactive Materials, 180 ft/roll .75" w x 1.38" l (1.90 x 3.5 cm) Suitable for test tubes, bottle necks, etc.

## Signs, Labels & Tags

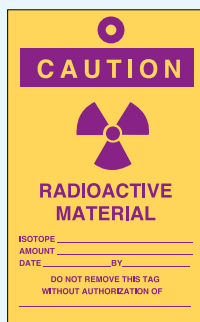

029-001

### Pre-Strung Tag

Extra strength cardboard with reinforced string hole.



028-002

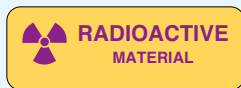

026-015



026-014

### Pressure Sensitive Warning Labels

Pre-cut labels are mounted on a paper backing. Simply peel off the pre-cut label and apply.

- 028-002** Label, Caution, Radioactive Material, 20/pkg  
5" w x 6" h (12.7 x 15.2 cm)
- 026-015** Label, Radioactive Material, 500/roll  
3" w x 1" h (7.6 x 2.5 cm)
- 026-014** Label, Caution, Radioactive Material, 500/roll  
2" w x 1" h (5 x 2.5 cm)

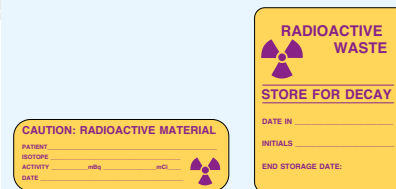

026-106

026-108



026-109 For documenting periodic checks of radioactive waste

### Radioactive Warning Labels

Protects staff and visitors.

- 026-106** Label, Caution, Radioactive Material, 320/roll  
3" w x .875" h (7.6 x 2.2 cm)
- 026-109** Label, Radioactive Waste, 240/roll  
4" w x 2.63" h (10.2 x 6.7 cm)
- 026-108** Label, Radioactive Waste, 320/roll  
2" w x 3" h (5 x 7.6 cm)

- 029-001** Tags, Container, 100/pkg  
2.63" w x 5.25" h (7 x 13 cm)





# Nuclear Medicine

Empowering Better, Safer Diagnosis & Treatment

- Dose Calibrators
- Thyroid Uptake
- Lung Ventilation
- Shielding
- Lead-Lined Cabinets



LAB SUPPLIES

# Shielded LAF



SHIELDED LAF

## Bio-Safety Cabinet

Capintec provides custom shielding for a wide range of hoods and enclosures. Whether you require an inch of lead surrounding a work area or 2 in. of PET thick shielding and an integral body shield for quality assurance or dose preparation, we can provide a shielded hood for your applications.

Fully shielded Biological Safety Cabinet and Radioisotope Fume Hoods feature a mobile body shield with lead glass, to view the working area while protecting the worker. The mobile body shield can be moved to allow replacement of filters and for certification and servicing the hood. The mobile body shield moves smoothly into place or out of the way. Detailed drawings and specifications for typical designs are available to assist your efforts. Drawings for custom configurations are available on request.

### Features:

- Standard shielding is 1' or 2" with custom shielding available
- Optional lead glass mobile body shield
- Flush mounting for dose calibrator ion chambers
- Environmental shielding for dose calibrator or other equipment
- 4' (122 cm) and 6' (183 cm) configurations available- Note that dimensions vary with shielding selection
- NSF listed
- Optional UV lighting

- 5730-30342** 4' Shielded A2 Bio-Safety Cabinet, 2" lead, with Sliding L block
- 5730-30344** 4' Shielded A2 Bio-Safety Cabinet, 2" lead, with Sliding L Block and Waste Cave
- 5730-30346** 4' Shielded B2 Bio-Safety Cabinet, 2" lead, with Sliding L Block
- 5730-30348** 4' Shielded B2 Bio-Safety Cabinet, 2" lead, with Sliding L Block and Waste Cave
- 5730-30350** 6' Shielded A2 Bio-Safety Cabinet, 2" lead, with Sliding L Block
- 5730-30352** 6' Shielded A2 Bio-Safety Cabinet, 2" lead, with Sliding L Block and Waste Cave
- 5730-30354** 6' Shielded B2 Bio-Safety Cabinet, 2" lead, with Sliding L Block
- 5730-30356** 6' Shielded B2 Bio-Safety Cabinet, 2" lead, with Sliding L Block and Waste Cave

## IMAGING QUALITY ASSURANCE

# Phantoms



Inserts for PET and Spect Phantoms

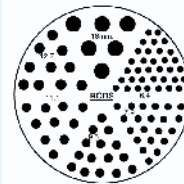

Cold Rods

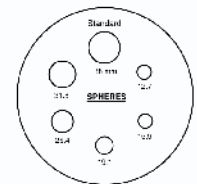

Cold Spheres

## Jaszczak SPECT Phantom

The Jaszczak SPECT Phantom provides consistent performance information for any SPECT or PET system. Multiple performance characteristics of camera-based SPECT systems are evaluated from a single scan of the phantom.

On-axis and off-axis transverse line spread function may be easily measured without removing the cover plate. Measurements of full-width-half (or tenth) maximum can be readily determined, either in air or in water.

The Phantom is used for:

- System performance valuation of: Collimator, Artifacts, Calibration, and Reconstruction Parameters
- Acceptance testing
- Routine quality assurance and control
- Evaluation of:
  - Center-of-rotation error
  - Non-uniformity artifact
  - Changes of radius-of-rotation on spatial resolution
  - Reconstruction filters on spatial resolution
  - Attenuation and scatter compensation
- Single slice volume sensitivity
- Total system volume sensitivity
- Lesion detectability

SPECT Phantoms are available in two models. The Deluxe Phantom is used for high resolution cameras. The Standard Phantom is used for lower resolution cameras.

### Specifications:

- Cylinder Interior Dimensions: 8.5" dia. x 7.32" h (21.6 x 18.6 cm)
- Cylinder Wall Thickness: 0.125" (3.2 mm)
- Volume: 6.9 L
- Volume With Inserts: 6.1 L
- Cold Rod Insert Height: 3.46" h (8.8 cm)
- Height of Spheres From Base Plate: 5" h (12.7 cm)

### 043-750 SPECT Phantom, Deluxe

- Cold Rod Dimensions: 4.8 mm, 6.4 mm, 7.9 mm, 9.5 mm, 11.1 mm, 12.7 mm
- Solid Sphere Diameters: 9.5mm, 12.7 mm, 15.9 mm, 19.1 mm, 25.4 mm, 31.8 mm
- Shipping Weight: 15 lb (6.9 kg)

### 043-762 SPECT Phantom, Standard

- Cold Rod Dimensions: 6.4 mm, 7.9 mm, 9.5 mm, 11.1 mm, 12.7 mm, 16.0 mm
- Solid Sphere Diameters: 12.7 mm, 15.9 mm, 19.1 mm, 25.4 mm, 31.8 mm, 38 mm

**043-750** Phantom, SPECT, Deluxe

### Related:

**043-763** Phantom Insert, Hollow Spheres

**043-730** Phantom Insert, Triple Line

**043-777** Phantom Insert, Cardiac

## Phantoms

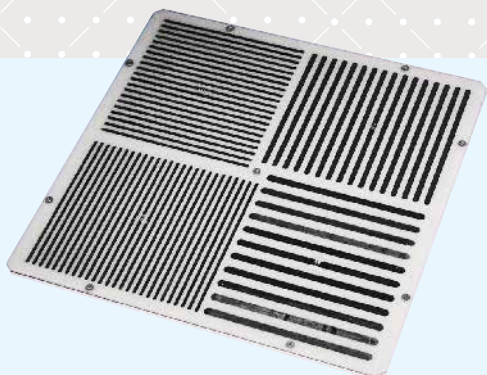

### Bar Phantoms

Four-quadrant Bar Phantoms offer precise determination of camera intrinsic resolution, collimator spatial resolution, field size and linearity. We offer a range of sizes manufactured to the highest quality standards.

#### Specifications:

##### Rectangular Bar Phantom

- Dimensions: 22.25" l x 17" w x .5" h (56.5 x 43.2 x 1.27 cm)
- Lead Bar Widths: .079", .098", .118" and .138" (2, 2.5, 3 and 3.5 mm)
- Field Across Bar Configurations: 21" l x 15.9" w (53.3 x 40.5 cm)
- Shipping Weight: 21 lb (10 kg)

##### Standard High Resolution Bar Phantom

- Dimensions: 16.875" l x 16.875" w x .5" h (43 x 43 x 1.28 cm)
- Lead Bar Widths: .25", .187", .156", and .125" (6.4, 4.8, 4 and 3.2 mm)
- Field Across Bar Configurations: 15.875" l x 15.875" w (40.3 x 40.3 cm)
- Shipping Weight: 14 lb (6 kg)

##### Cardiac Bar Phantom

- Dimensions: 15.5" l x 9.25" w x .5" h (39.4 x 23.5 x 1.27 cm)
- Lead Bar Widths: .079", .098", .118" and .138" (2, 2.5, 3 and 3.5 mm)
- Field Across Bar Configurations: 14.5" l x 8.25" w (36.8 x 21 cm)
- Shipping Weight: 15 lb (6.80 kg)

##### Symbia and E-Cam Bar Phantom

Includes two removable screw knobs for insertion/removal of phantom from camera head.

- Dimensions: 16" l x 21" w x .5" h (40.6 x 53 x 1.27 cm)
- Lead Bar Widths: .079", .098", .118" and .138" (2, 2.5, 3 and 3.5 mm)
- Field Across Bar Configurations: 20.3" l x 14.875" w (51.6 x 37.8 cm)
- Shipping Weight: 19 lb (8.7 kg)

<b>243-935</b>	Bar Phantom, Rectangular
<b>243-800</b>	Bar Phantom, Standard, High Resolution
<b>243-987</b>	Bar Phantom, Symbia and E-Cam



### NEMA 2012 PET Phantom

#### Features:

- Complies with NEMA 2012 Standard
- Simulation of whole-body imaging using PET and camera-based coincidence imaging techniques
- Evaluation of reconstructed image quality in whole-body PET and camera-based coincidence imaging
- Determination of the coincidence count rate characteristics in brain and cardiac imaging
- Evaluation of the relationship between true coincidence count rate and radioactivity
- Determination of the address errors caused by address pile up
- Evaluation of the count loss correction scheme

#### Specifications:

- Dimensions: 9.5" h x 12" w x 9.5 depth (24.1 x 30.5 x 24.1 cm)
- Interior Length of Phantom: 180 mm
- Fillable Spheres (six) Inner Diameter: 10 mm, 13 mm, 17 mm, 22 mm, 28 mm and 37 mm
- Distance From Sphere Plane to Inside Wall: 70 mm
- Volume of Empty D Shaped Cylinder: 9.7 L
- Cylindrical Insert Dimension: O.D.: 51 mm dia. x 180 mm length
- Shipping Weight: 11 lb (4.9 kg)

*Performance Measurements of Positron Emission Tomographs, NEMA Standards Publication No. NU2, National Electrical Manufacturers Association (NEMA), Washington, DC, 2012 NEMA 2012ForPETForPET*

<b>043-767</b>	Phantom, PET, NEMA 2012
----------------	-------------------------

# Phantoms

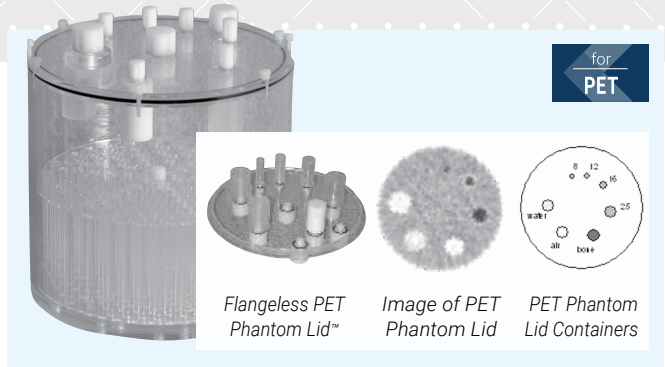
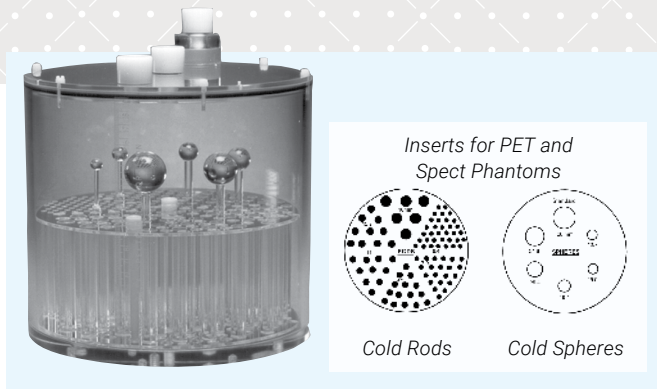

## Jaszczak Flangeless Deluxe SPECT Phantom

The flangeless PET and SPECT phantoms provide consistent performance information for any PET or high-resolution SPECT system. Multiple performance characteristics of camera-based SPECT systems are evaluated from a single scan of the phantom.

On- and off-axis transverse line spread function may be easily measured without removing the cover plate. Measurements of full-width-half (or tenth) maximum can be readily determined, either in air or in water.

The flangeless phantoms for PET and SPECT meet the requirements set by the ACR.

The Phantoms are used for:

- System performance evaluation of: Collimator, Artifacts, Calibration, and Reconstruction Parameters
- Acceptance testing
- Routine quality assurance and control
- Evaluation of:
  - Center-of-rotation error
  - Non-uniformity artifact
  - Changes of radius-of-rotation on spatial resolution
  - Reconstruction filters on spatial resolution
  - Attenuation and scatter compensation
- Single slice volume sensitivity
- Total system volume sensitivity
- Lesion detectability

## Esser Flangeless Deluxe PET Phantom

### Specifications:

SPECT and PET Phantoms:

- Cylinder Interior Dimensions: 8" dia. x 7.32" h (20.4 x 18.6 cm)
- Volume: 6.4 L
- Cold Rod Insert Height: 3.46" h (8.8 cm)
- Cold Rod Diameters: 4.8, 6.4, 7.9, 9.5, 11.1 and 12.7 mm
- Height of Spheres From Base Plate: 5" h (12.7 cm)
- Solid Sphere Diameters: 9.5, 12.7, 15.9, 19.1, 25.4 and 31.8 mm

Flangeless Esser PET Phantom Lid:

- Refillable thin-walled cylinders: 8, 12, 16, 25 (x3) mm
- Solid cylinder (Teflon): 25 mm
- Cylinder height: 1.5 in
- Lid Closure: Bayonet-Style with Lock Screw

- 043-765** Phantom, SPECT, Flangeless, Deluxe
- 043-772** Phantom, PET, Flangeless, Esser
- 043-757** Phantom, PET/SPECT, Flangeless  
*Includes PET and SPECT phantom lids*

- Related:**
- 043-763** Phantom, Hollow Spheres Set (6)
  - 043-730** Phantom Insert, Triple Line
  - 043-777** Phantom Insert, Cardiac



## Phantoms

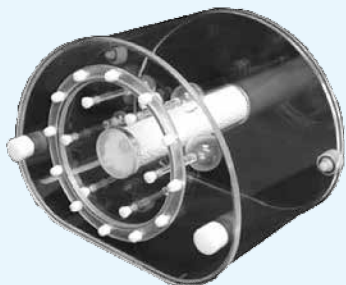

### NEMA IEC PET Body Phantom Set™

*A body phantom, a lung insert and an insert with six spheres with various sizes*

#### Features:

- The NEMA IEC Body Phantom Set consists of a body phantom, a lung insert and an insert with six spheres with various sizes
- It is designed in accordance with the recommendations by the International Electrotechnical Commission (IEC) and modified by the National Electrical manufacturers Association (NEMA)
- It is recommended for use in the evaluation of reconstructed image quality in whole body PET imaging

#### Applications

- Simulation of whole-body imaging especially using PET and camera-based coincidence imaging techniques
- Evaluation of reconstructed image quality in whole body PET and camera-based coincidence imaging
- Determination of the coincidence count rate characteristics in brain and cardiac imaging
- Evaluation of the relationship between true coincidence count rate and radioactivity
- Determination of the address errors caused by address pile up
- Evaluation of the count loss correction scheme
- Research

#### Specifications:

- Interior length of phantom: 180 mm
- Fillable spheres (6) inner diameter: 10 mm, 13 mm, 17 mm, 22 mm, 28 mm, and 37 mm.
- Distance from sphere plane to inside wall: 70 mm
- Volume of empty cylinder: 9.7 liters
- Cylindrical insert dimension:  
Outside diameter: 51 mm x length: 180 mm

**5250-0161** NEMA IEC Body Phantom Set



### Cardiac Insert

This insert provides a multi-function simulation of the left ventricle, and can be used to evaluate SPECT imaging of cold defects within the "myocardium." Two solid acrylic sectors (45 and 60 degrees) are supplied with the insert, each 1 cm thick and 2 cm long. These non-filling defects may be placed at various positions within the "ventricle wall", either anteriorly or posteriorly. The long axis of the "ventricle" is adjustable from 30 to 60 degrees from the long axis of the cylinder. Four fillable defects are also included.

Used to evaluate cardiac ECT data and attenuation/scatter. Simulates normal and abnormal myocardial uptake. Solid inserts simulate transmural and non-transmural cold abnormalities. Fillable inserts simulate transmural and non-transmural cold or hot abnormalities.

#### Specifications:

- "Ventricle" Overall Dimensions: 3.7" l x 2.4" dia. (9.3 x 6.1 cm)
- "Ventricle" Volume: ~ 60 ml
- "Myocardium" Thickness: 0.4" (1.0 cm)
- "Myocardium" Volume: ~ 110 ml
- Solid Defect Set (three pieces):
  1. 60° x 2 cm (h) x 10 mm (thick)
  2. 45° x 1.53 cm (h) x 10 mm (thick)
  3. 60° x 2 cm, with 5 mm wall thickness (non-transmural defect)
- Fillable Defect Set (four pieces):
  1. 180° x 2 cm (h) x 10 mm (thick) / Vol ~ 13 ml
  2. 90° x 2 cm (h) x 10 mm (thick) / Vol ~ 5.4 ml
  3. 45° x 2 cm (h) x 10 mm (thick) / Vol ~ 3.8 ml
  4. 45° x 2 cm (h), with 5 mm thick chamber / Vol ~ 1.4 ml

**043-777** Phantom Insert, Cardiac  
*Includes: Defect Set*

**Related:**  
**043-765** Phantom, SPECT, Flangeless  
**043-772** Phantom, PET, SPECT, ACR  
**043-750** Phantom, SPECT, Deluxe



# Phantoms



## Triple Line Insert

Used to produce three 1 mm diameter parallel lines of tracer material spaced 7.5 cm apart. The locations of the fillable tubes are based on the recommendations in the NEMA Standards Publication for Performance Measurements of Scintillation Cameras, 1986.

Radioactive tracer liquid can be inserted into the line sources through surgical grade, stainless steel valves located at the ends of each line tube. The cylinder can be filled with water to simulate the surrounding attenuating medium. Quantitative measurements of on-axis and off-axis reconstructed line source resolutions can be performed in air by placing the triple line insert directly on the scanning bed. The triple line insert provides accurate, reproducible images to quantitatively evaluate the effects of errors in center-of-rotation and radius-of-rotation on scanners. Using the insert, the influence of the type of reconstruction filter on SPECT spatial resolution measurements can be evaluated.

### Specifications:

- Useful Height of Line Sources: 2.76" (7 cm)
- Diameter of Insert: 7.3" (18.6 cm)
- Diameter of Line Sources: ~1 mm
- Spacing of Line Sources: 2.95" (7.5 cm)
- Shipping Weight: 3 lb (1.3 kg)

**043-730** Phantom Insert, Triple Line

### Related:

- 043-765** Phantom, SPECT, Flangeless
- 043-772** Phantom, PET, SPECT, ACR
- 043-750** Phantom, SPECT, Deluxe

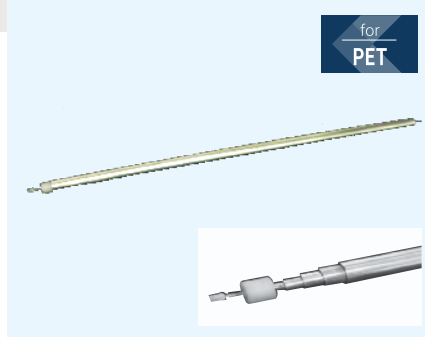

## NEMA PET Sensitivity Phantom™

Six Concentric aluminum tubes used to detect camera sensitivity in PET.

### Specifications:

Five internally stacked concentric aluminum tubes all 700 mm in length

- 1st Tube  
Inside Diameter: 3.9 mm  
Outside Diameter: 6.4 mm
- 2nd Tube  
Inside Diameter: 7.0 mm  
Outside Diameter: 9.5 mm
- 3rd Tube  
Inside Diameter: 10.2 mm  
Outside Diameter: 12.7 mm
- 4th Tube  
Inside Diameter: 13.4 mm  
Outside Diameter: 15.9 mm
- 5th Tube  
Inside Diameter: 16.6 mm  
Outside Diameter: 19.1 mm
- Innermost Tube  
(a fillable polyethylene tube)  
Inside Diameter: 1 mm  
Outside Diameter: 3 mm

*Performance Measurements of Scintillation Cameras, NEMA Standards Publication No. NU2, National Electrical Manufacturers Association (NEMA), Washington, D.C., 2001*

**5250-0165** NEMA PET Sensitivity Phantom



## Hollow Sphere Inserts

### Features:

- Designed for use in all circular and elliptical SPECT cylinders
- Simulates hot and cold spherical "lesions"
- Quantitative evaluation of spatial resolution/object size, attenuation and scatter effects
- Evaluation of quantitative ECT reconstruction methods

### Specifications:

- Set: Six hollow spheres (each individually removable and fillable)
- Diameter: I.D.: 9.9 mm, 12.4 mm, 15.6 mm, 19.7 mm, 24.8 mm, and 31.2 mm
- Volume of Spheres: 0.5 ml, 1.0 ml, 2.0 ml, 4.0 ml, 8.0 ml, and 16.0 ml

**043-763** Phantom Insert, Hollow Spheres

### Related:

- 043-765** Phantom, SPECT, Flangeless
- 043-750** Phantom, SPECT, Deluxe

## CT QA



## MRI QA

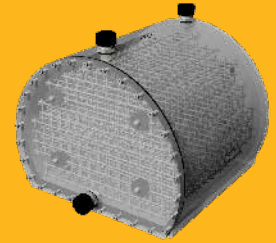

## Ultrasound QA



# Comprehensive Diagnostic Imaging Phantoms from Mirion Medical

Better Quality Management. Better Care.

- CT Phantoms
- MRI Phantoms
- Ultrasound Phantoms
- Mammography Phantoms

For additional information visit, [sunuclear.com/diagnostic](http://sunuclear.com/diagnostic)



**SUN NUCLEAR**  
A MIRION MEDICAL COMPANY

## Advanced CT QA

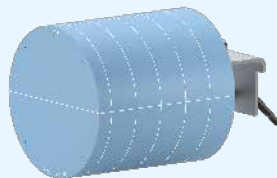

## Mammography QA

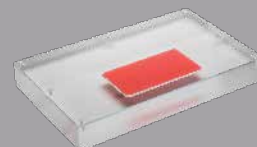
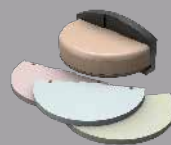

001-075	67	007-635	48	026-005	101	046-275	94		30	132-690	37	150-971	96	244-192	78	5430-0058	5,7,
001-075	53	007-652	48	026-012	101	050-200	54	0680-0013	74	132-691	37	150-991	96	244-200	76		9,19,27
001-179	54	007-661	47	026-013	101	050-205	54	0680-0017	74	132-692	38	177-075	32	244-205	76	5430-0100	5,7,
001-180	54	007-663	47	026-014	102	050-250	54	0960-0183	18	132-695	39	177-090	32	5120-0176	24		9,19
001-181	54	007-665	47	026-015	102	053-610	51	0975-0002	86	132-698	39	177-091	32	5120-2144	17	5430-30151	21
001-182	54	007-675	46	026-020	100	053-611	51	0975-0003	86	132-699	38	177-092	32	5120-2257	11	5430-30152	21
001-236	52	007-680	46	026-106	102	053-806	51	0975-0006	86	132-750	40	177-095	33	5120-2258	11	5430-30154	21
001-280	63, 64,	007-685	46	026-108	102	053-807	52	0975-0008	86	132-770	38	177-124	33	5120-2286	16	5430-3136	27
	65	007-691	47	026-109	102	0550-0003	69	0975-0025	89	132-771	38	177-324	33	5126-2001	11,15	5510-3003	67
001-281	63, 64,	007-693	47	028-002	102	060-133	43	0975-0137	28	132-772	42	177-325	33	5130-0006	5,13,	5530-1030	68,72
	65	007-695	47	029-001	102	060-137	43	0975-137R	27,89	132-773	42	185-302	41		14	5530-1031	67
001-282	63, 64,	007-716	49	033-013	94	0601-0003	93	0975-139X	87	132-774	38	2001-0055	19	5130-20252	18	5530-20179	57
	65	007-717	49	033-304	94	0601-0009	95	0975-152R	27,89	132-781	37	208-070	94	5130-20253	13	5530-2074	72
001-283	65, 63	007-718	49	039-106	57	0601-0019	95	0975-3720	86	132-784	37	208-075	94	5130-20254	13	5530-2077	68
001-284	59, 64,	007-723	46	039-110	57	063-140	89	0975-3725	86	132-793	38	208-080	94	5130-2046	5,13,	5550-0002	70
	65	007-734	46	039-326	56	063-261	86	0975-5710	86	134-772	38	208-085	94		14	5730-0032	71
001-706	52, 61	007-735	46	040-108	57	063-362	87	099-289	88	135-022	90	214-210	91	5130-2046	5	5730-2271	56,76
001-707	52, 61	007-736	46	040-315	54	063-562	86	1000-0208	70	136-755	34,35	214-220	90	5130-2086	70	5730-30342	106
001-708	60	007-738	46	042-407	73	063-586	86	1000-0211	69	139-101	42	214-610	91	5130-2090	69,71	5730-30344	106
001-711	52, 61	007-755	46	042-433	66,76	063-700	88	101-103	35,87	139-102	41	214-728	92	5130-2161	71	5730-30346	106
001-721	59, 60,	007-945	49	042-434	72,76,	063-701	88	101-356	86	139-104	42	243-800	108	5130-2216	9,84,	5730-30350	106
	61, 62	007-956	47		66,84	063-720	86	103-701	74	139-677	40	243-935	108	5130-2238	7	5730-30352	106
001-723	60	007-957	47	042-435	66,72	0645-0022	92	121-073	100	139-680	41	243-987	108	5130-30251	11,	5730-30354	106
001-724	61	007-958	47	042-448	84	0645-0025	93	127-691	47	150-000	97	244-004	82		18	5730-30356	106
001-726	59, 60,	007-961	50	042-456	83	0645-0025	96	127-693	47	150-001	96	244-005	82	5130-30261	11	7120-1199	5,7,
	61	007-962	50	042-519	73	0645-0026	93	127-695	47	150-005	96	244-006	83	5130-3234	5		9,17
001-730	59, 60,	007-968	50	042-522	73	0645-0026	96	127-734	46	150-025	96	244-007	78	5130-3235	7,76	7300-2004	5,7,
	61	007-973	50	043-274	88	0651-0023	98	127-735	46	150-122	96	244-008	78	5230-0038	21,23		9,13,16
001-739	59	007-974	49,50	043-730	107,	0651-0024	98	127-738	46	150-125	96	244-009	82	5250-0161	110	7300-2005	5,7,
001-754	63, 64	007-975	50		109,111	0652-0038	44	130-019	42	150-126	96	244-111	77	5250-0165	111		7,11,
001-756	64	007-980	50	043-750	107,	0652-0040	44	130-020	42	150-127	96	244-112	77	5250-0212	28		15
001-757	64	007-999	53		110,111	0652-0041	44	130-100	40	150-130	96	244-121	81	5250-0213	28	7310-1302	70
001-771	52, 59,	008-300	56	043-757	109	0652-0043	45	130-639	41	150-160	96	244-122	81	5250-0214	28	7310-1305	69
	61, 62, 64	008-400	63, 65	043-763	107,	0652-0047	45	130-900	34,43	150-315	34,35	244-131	80	5250-0215	28	7315-1850	21,24
001-779	64	009-205	53		109,111	066-536	53,93,	130-901	43	150-317	35	244-132	80	5250-2110	28	7410-0023	72
001-785	59, 65	011-012	92	043-765	109,		96	130-902	43	150-771	96	244-141	77	5420-0086	23		72
001-786	59	011-036	92		110,111	0660-0018	55	130-903	43	150-773	96	244-142	77	006-350	23	7300-2903	7,11,
001-787	59	024-900	101	043-767	108	0660-0019	55	130-904	43	150-780	96	244-151	79	5420-0087	30		15
001-788	64, 65	024-910	101	043-772	109,	0660-0038	55	132-319	34	150-781	96	244-152	79	5420-0121	27,29	7410-0024	72
001-789	64, 65	024-911	101		110,111	0660-0042	56,76	132-503	34	150-782	96	244-161	79	5420-2072	17	7410-0025	72
001-793	62	024-914	101	043-777	107,		84	132-504	34	150-783	96	244-162	79	5420-2137	29	7900-0352	27
001-794	62	024-916	101		109,110	0660-1811	55	132-555	34	150-785	96	244-171	80	5420-2141	16,27,	9282-0009	19,27
001-798	59	024-923	101	043-840	85	0660-1813	55	132-680	37	150-951	96	244-172	80		29		
006-352	23	024-948	101	043-845	85	0665-2014	68	132-681	37	150-952	96	244-181	81	5420-2164	21		
007-007	54	024-957	101	043-860	85	0665-2017	48,67	132-684	37	150-960	96	244-182	81	5430-00007	21,		
007-612	48	024-999	101	043-861	85	0670-0016	24,27,	132-685	39	150-961	96	244-191	78		22		



**MIRION**  
MEDICAL

Radiation Therapy | Occupational Dosimetry | Nuclear Medicine  
Medical Imaging Tables | Diagnostic Imaging QA

# Driving the Science of Better.

At Mirion Medical, we partner with a broad range of customers to better the human condition. From radiopharmaceutical development and preparation through cancer diagnosis and treatment, our solutions help ensure the safety and enhance the delivery of healthcare.

[mirion.com/medical](http://mirion.com/medical)



## OUR NEWEST MIRION MEDICAL BRAND



**ec<sup>2</sup> SOFTWARE**

## Powering Precision Medicine

Our Nuclear Medicine and Molecular Imaging software solutions simplify workflows and reduce errors to create streamlined operational processes for the radiopharmaceutical field.

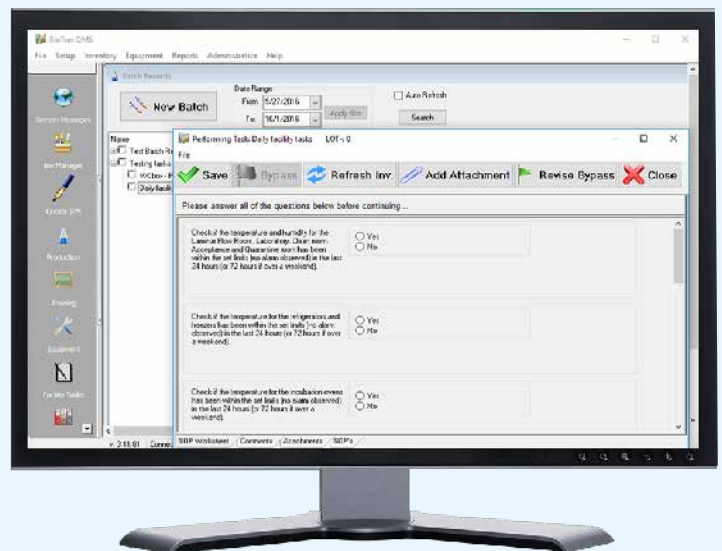

## Empowering Better, Safer Diagnosis & Treatment

From dose preparation to patient administration, our **Nuclear Medicine** solutions and supplies enhance safety and accuracy to aid potentially life-saving imaging and therapy.



## Made Better to Support Better Patient Care

The incomparable engineering and user-focused design of our **Medical Imaging** tables enhance the value of user investment, helping them deliver a quality patient experience for years to come.



## Delivering Better Tools for Safer Workspaces

Our **Occupational Dosimetry** products and services remove the worry of radiation from the daily routines of those who are exposed at work.



## Better Quality Management, Better Care

Our comprehensive Radiation **Therapy and Diagnostic Imaging** solutions enhance the checks and balances that keep cancer detection treatment safe, effective, and ever-improving.

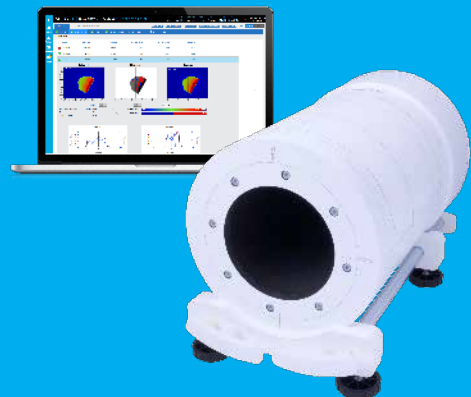

Capintec Nuclear Medicine and Molecular Imaging products  
better the human condition by protecting people from  
exposure during potentially life-saving diagnosis and therapy.

**Capintec, Inc.**

**Phone**

+1 (800) 631-3826

+1 201 825-9500

**Address**

7 Vreeland Road,  
Florham Park, New Jersey  
07932

[capintec@mirion.com](mailto:capintec@mirion.com)



**CAPINTEC**  
A MIRION MEDICAL COMPANY

Copyright © 2024 Mirion Technologies, Inc. or its affiliates. All rights reserved. Mirion, the Mirion logo, and other trade names of Mirion products listed herein are registered trademarks or trademarks of Mirion Technologies, Inc. or its affiliates in the United States and other countries. Third party trademarks mentioned are the property of their respective owners.

MKTG-2617 09/2024