

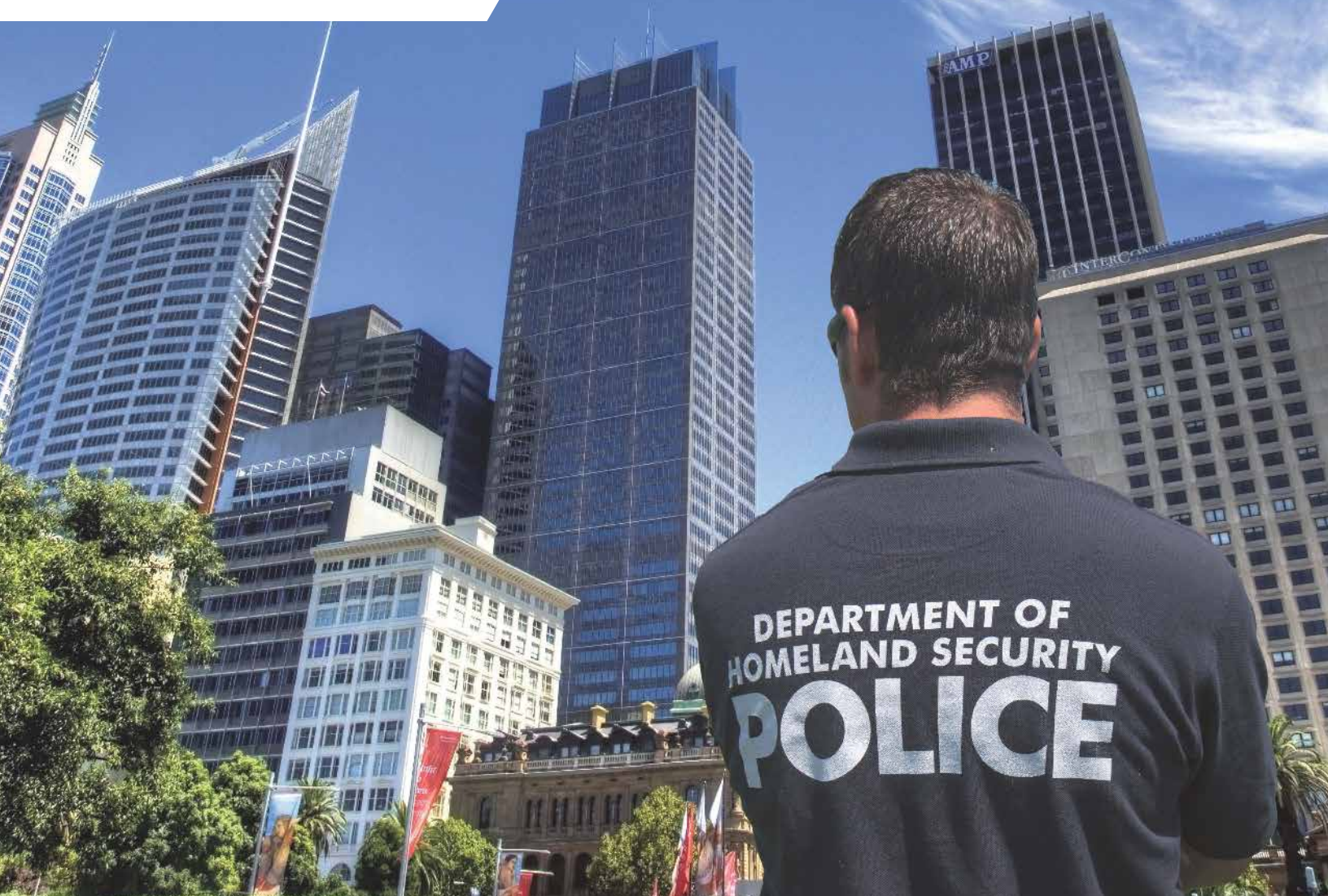

MIRION
TECHNOLOGIES



RADIOLOGICAL DETECTION AND
MEASUREMENT SOLUTIONS FOR

Homeland Security and Military





Radiation Monitoring Solutions

Mirion meets the exacting standards of military and homeland security stakeholders.

Handheld Detection3-6

Handheld radionuclide identification devices for a fast, accurate and reliable measurement.

Personal Dosimetry7-9

Dosimetry systems designed for military forces. They feature extreme durability, reliable performance and are capable of operation in harsh environments.

Portable Detection & Identification Systems10-11

Portable instrumentation and identification systems for radiation and contamination surveillance in any military and CBRNE environments.

Mobile Detection & Identification Systems.....12-14

Ground, aerial and maritime surveillance of large areas with real-time mapping and radiological measurement data.

Pedestrian and Vehicle Portal Monitoring Systems....15-17

Border checkpoints or special events with an important flow of vehicles also need to detect any radioactive material before it is crossing the checkpoint.

Remote Situational Awareness18-19

The threat of terrorism emphasizes the need for efficient and reliable monitoring of infrastructures and events to mitigate radiological risks. Emergency response teams must be ready to assess these risks through a high level of situational awareness to protect people, property and the environment.

Tactical Detection and Measurement.....20-25

Mirion meets the exact standards of military and homeland security stakeholders. Our durable and highly sensitive devices are built for harsh battlefield environments, infrastructure protection, search and security applications.

Innovative Solutions26-27

Mirion understands that each customer's situation is unique and usually requires some type of customization. Our experts are ready to work with you to meet your requirements. Mirion also offers comprehensive simulator training using real instruments

Handheld Detection

AccuRad™ PRD: Personal Radiation Detector BY and FOR Emergency Responders

FEATURES

- ✓ Gamma Detectors: CsI with SiPM and Silicon Diode
- ✓ Accurate Dose (to 1000 rem) and Dose Rate (to 1000 rem/hr)
- ✓ Innovative Varying Background Suppression algorithm detects real threats and hazards
- ✓ Solid and durable, with impact resistant bi-material construction
- ✓ Radar directionality for source localization
- ✓ Dual-display design
- ✓ IP-67 rated (dust and water) ingress protection
- ✓ More than 900 hours battery life
- ✓ Easy, intuitive use!
- ✓ Low cost of ownership

APPLICATIONS

- ✓ Interdiction and Emergency Response
- ✓ Public Safety at Large Events
- ✓ Critical Infrastructure Protection
- ✓ Border Security

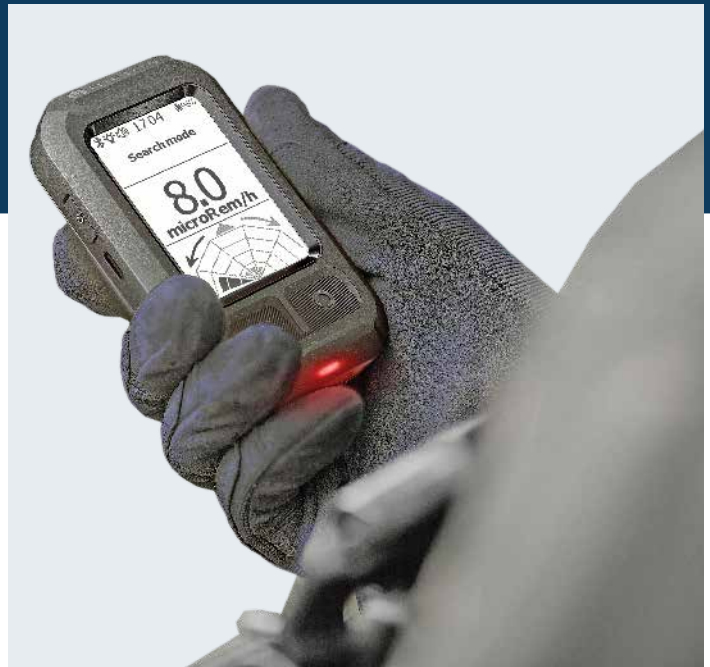

Handheld Detection

AccuRad Smartphone App

FEATURES

- ✓ Android and iOS versions



- ✓ NFC pairing with Bluetooth® communication



- ✓ Single or Batch configurations
- ✓ Reach-back event data to the cloud:
 - Email
 - SMS
 - RadResponder
 - SIGMA Network
 - SpirVIEW Mobile™ Supervisor (real-time streaming)

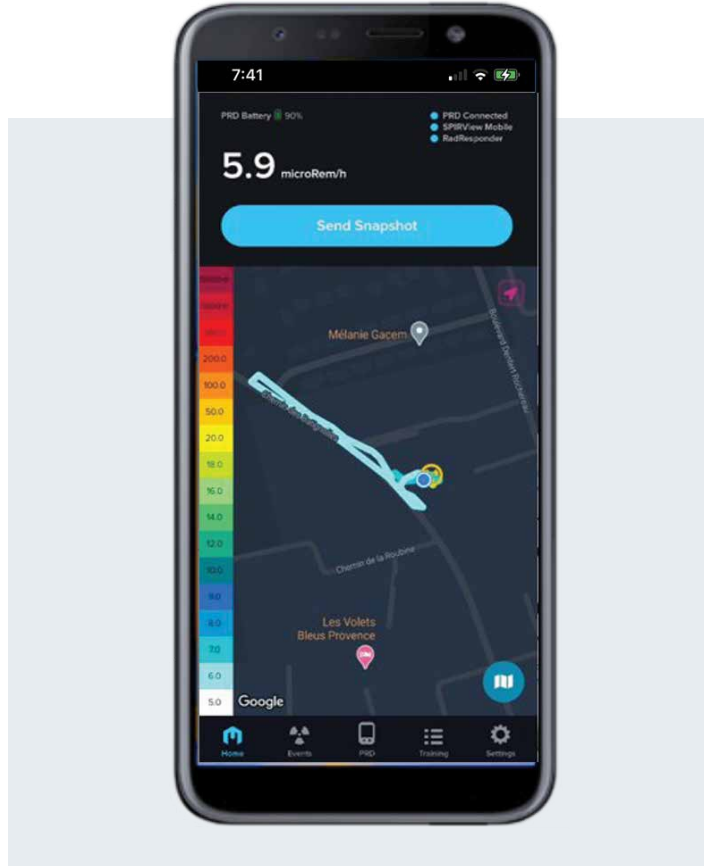



UltraRadiac™-Plus Personal Radiation Monitor

FEATURES

- ✓ Industry standard radiation monitor for first responders
- ✓ Measure/display dose rate and total dose
- ✓ “Time to Alarm” feature displays time remaining to dose alarm
- ✓ Large, easy-to-read backlit LCD display
- ✓ Audible, visual and vibrating alarms
- ✓ Designed to operate in extreme environments
- ✓ Easy to use with PPE Gloves
- ✓ Uses COTS AAA batteries
- ✓ Derived from military qualified AN/UDR-13, 14 & 15

APPLICATIONS

- ✓ Fire-Rescue
- ✓ Law Enforcement
- ✓ Vehicle monitor



Vehicle Mount



Handheld Detection

RDS-32™ Radiation Survey Meters

The RDS-32 Survey Meters are small handheld, battery operated radiation survey instruments. Due to its versatile functions and durability it is suited for a wide range of applications in civil defense, industrial use, nuclear power plants, laboratories, etc.

The meter features excellent ergonomics; lightweight and easy handling, with visual, audible, and vibration functions. Each meter includes an additional battery cover with belt clip to make it wearable, freeing the user's hands to focus on their primary job.

FEATURES

- ✓ H*(10) dose equivalent rate according to latest standards
- ✓ External alpha, beta, gamma and neutron probes for direct connection
- ✓ RDS-32WR meter for wider dose rate range
- ✓ iTx versions for wireless monitoring
- ✓ 4-way navigation keys, practical shortcuts
- ✓ Intuitive user interface
- ✓ Large graphic screen, configurable backlight
- ✓ Automatic display rotation with tilt sensor
- ✓ High impact durable case construction, IP67 immersion proof
- ✓ Internal memory allows versatile histogram functions and the ability to manually store measurements
- ✓ Configuration and firmware upgrade done through the CSW-32™ Software with a USB cable-link
- ✓ Complies with IEC 60846 standards, designed to meet ANSI 42.17A, 42.17C standards



RDS-32iTx + SN-D-2™
Neutron Dose Probe



RDS-32 + GMP-25™
Alpha/Beta/Gamma Probe

RDS-32 + SAB-100™
Alpha/Beta Probe

Personal Dosimetry

DMC 3000™ Electronic Alarming Dosimeter

The DMC 3000 Personal Electronic Dosimeter features superior gamma and X-ray energy response, programmable alarms with visual LED, audible, and vibrating alarm indicators, simple 2-button navigation, and the ability to be fitted with external modules for expanded capabilities.

FEATURES

- ✓ Modules for Telemetry, Beta and Neutron measurements
- ✓ Pocket and Belt Clips
- ✓ Military Grade EMI Immunity
- ✓ AAA Alkaline Battery – 9 months
- ✓ Meets/exceeds applicable ANSI & IEC standards

APPLICATIONS

- ✓ Protective monitoring for radiological response operations by first responders and emergency management personnel
- ✓ Remote area or vehicle radiological monitoring



DMC 3000 family of dosimeters with optional beta, neutron or gamma sensitive PRD modules

Personal Dosimetry

SOR-R/T Ambient/LLR and Tactical Electronic Dosimeter

The SOR/T™ dosimeter for tactical (gamma and neutron) and residual/ambient gamma measurements. The SOR/R™ dosimeter for residual/ambient gamma measurements and qualified in accordance with current military and civil standards. The SOR line exceeds many of the standards currently in use in order to account for harsh operational environments.

FEATURES

- ✓ Waterproof, lightweight and small
- ✓ Prompt Gamma and Neutron detection
- ✓ TREE Protection
- ✓ Over 1-year battery life
- ✓ MIL-STD 461 and 801 compliance
- ✓ Multiple Reader options

APPLICATION

- ✓ Protective monitoring for radiological response operations in tactical environments



XOM/T and XOM/R reader/recorder are portable and autonomous equipment designed for field management of personal or collective dosimetry, when measured with SOR/T or SOR/R dosimeters.



Designed to be worn comfortably on the wrist, or clipped to a garmet. It is lightweight and low profile in size. The edges are rounded to accommodate clothing and gear.



U.S. Army photo by Tech. Sgt. Caycee Watson

MBD-2™ Tactical/Occupational Personal Dosimeter

The MBD-2 dosimeter is a real-time, self-indicating device and is based upon Mirion Technologies' patented* Direct Ion Storage (DIS) technology.

FEATURES

- ✓ Measures and records dose for gamma and neutron-from occupational to prompt nuclear exposures
- ✓ NFC and/or Bluetooth Low Energy communication
- ✓ Self-reading for effective decision making
- ✓ Hands-free operation
- ✓ Programmable display
- ✓ Configurable operating parameters
- ✓ Wrist worn or clipped to lanyard or garment
- ✓ Internal histogram
- ✓ Pulsed-xray measurements to 65 nsec pulses

APPLICATIONS

- ✓ Emergency responders
- ✓ Radiography
- ✓ Civilian Support Teams

*US Patent 9,151,848.

Portable Detection & Identification Systems

SPIR-Ace™ Radio Isotope Identification Devices (RIID)

The SPIR-Ace unit is a versatile Radio Isotope Identification Devices (RIID) addressing all applications requiring efficient detection and identification of radiological threats.

FEATURES

- ✓ Detectors: Gamma (2 x 1.4 in. NaI, also LaBr₃) and Neutron (⁶LiZnS)
- ✓ Self stabilizes without internal source
- ✓ Key features:
 - Source direction search – “Radar”
 - Integrated energy calibration module
 - Genie Export for activity determination
- ✓ Big library: 80 radionuclides in over five categories:
 - HLS, Nuclear Accident (early/late), Labs, Waste, Spent Fuel
 - ID replay capability using different library
- ✓ Optional external alpha-beta contamination probe
- ✓ Easy-to-use Android OS with touch screen
- ✓ Reach-back events with Wi-Fi or Cellular (email, cloud server, etc.)

APPLICATIONS

- ✓ Handheld for search/localize/ID, confirm for reachback
- ✓ Hidden (backpack, case, etc.) with Earphone
- ✓ Stationary monitor with remote (smartphone/tablet) display



Directional Radar

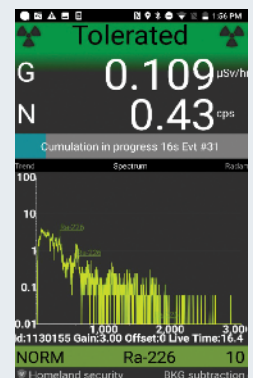

Real-time Spectrum

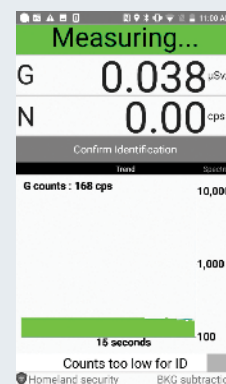

Trend Display

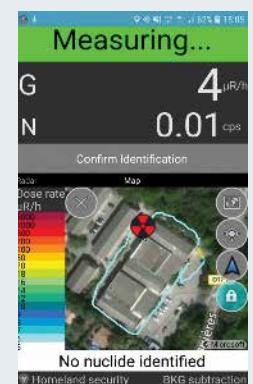

Mapping

Portable Detection & Identification Systems



SPIR-Pack™ Human Portable Radiation Detection and Identification System

Transportable System for Detection & Identification.

FEATURES

- ✓ Versatile for mobile and fixed monitoring with real-time mapping
- ✓ Big library: 80 radionuclides in over five categories – ID replay capability using different library
- ✓ ~23 lb total weight (GN) <15 lb (G)
- ✓ Easy-to-use Android OS with touch screen
- ✓ Reach-back event and map data with integrated Wi-Fi or Cellular (email, cloud server, etc.)

KEY FEATURE SOURCE LOCALIZATION

- ✓ Directional indicator helps the Operator locate the detected source
- ✓ Unique “Radar Scope” with compass and sectors for visualization of radiation intensity and location proximity



APPLICATIONS

- ✓ Worn as a traditional backpack
- ✓ Mobile vehicle monitoring and mapping
- ✓ Transportable portal for pedestrian screening



Mobile Detection & Identification Systems

SPiR-Ident™ Mobile Advanced Spectroscopy Platform

The SPiR-Ident Mobile Platform is a modular and scalable system that can be configured for easy deployment in vehicles, compact transportable modules, or in low profile (stealth) configurations.

FEATURES

- ✓ Real-time mobile search and identification of radioactive and nuclear materials, with integrated mapping
- ✓ Detectors: Gamma (2 or 4 L NaI) and Neutron (BZnS), scalable volumes (2-4-8-16 L) to meet enduse applications
- ✓ Stackable case enclosures
- ✓ Water/temperature/shock resistant, stackable enclosures
- ✓ Easily adaptive for Vehicle-Air-Marine use
- ✓ Instant configuration as a Pedestrian or Vehicle Portal Monitor
- ✓ Source-less Training Mode
- ✓ Integrated Flight or Mission Planning

APPLICATIONS

- ✓ Background and contamination mapping
- ✓ Search
- ✓ Emergency response (pedestrian, vehicle screening)



SPiR-Ident Mobile Platform utilized on a helicopter, car and boat:



Mobile Detection & Identification Systems

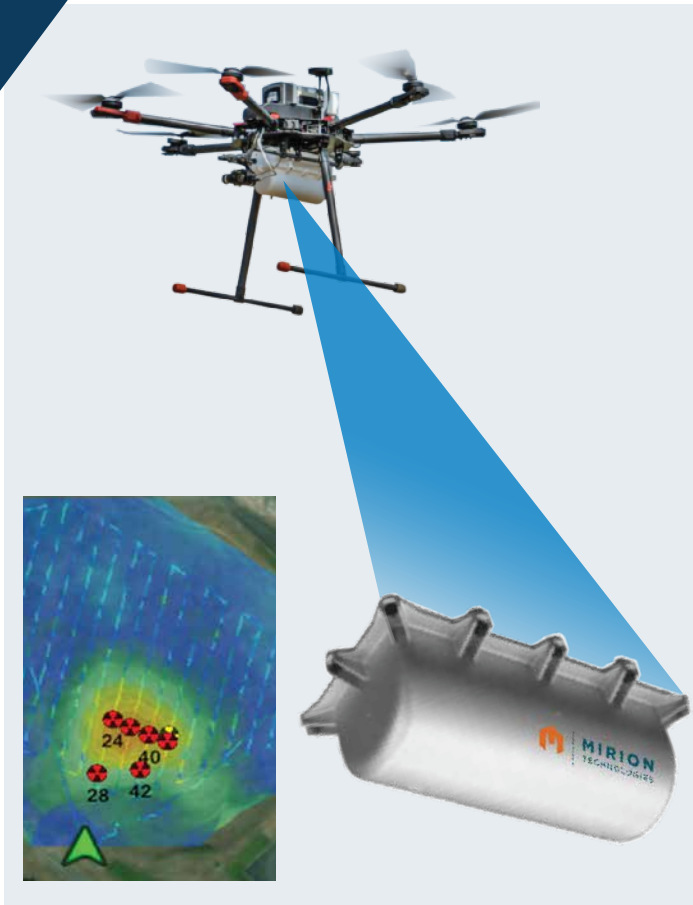

SPIR-Explorer™ Sensor

The SPIR-Explorer sensor is a lightweight radiation detector designed to be mounted on a UAV/Drone or UGV/Robot for a wide range of applications where radiation detection, measurement, and nuclide identification is needed. This includes environmental surveys, military reconnaissance, Radiological Dispersal or Exposure Device (RDD or RED) detection, hospitals/industry fire hazards, nuclear power plant emergency response.

FEATURES

- ✓ Real-time, instant Detection, Measurement and Identification
- ✓ Wide dose rate range: from natural background to high accident levels
- ✓ Light and robust
- ✓ Simple and fully automated use
- ✓ Lightweight means smaller drone or longer flight time
- ✓ 1000 times more sensitive than most of the GM-based sensors for drones
- ✓ Extrapolation of the measurements at ground level
- ✓ Count rate per radionuclide

APPLICATIONS

- ✓ Aerial and vehicle radiological surveillance
- ✓ Emergency response
- ✓ Mapping



SPIR-Explorer Sensor on Spot® agile mobile robot (Boston Dynamics)

Mobile Detection & Identification Systems

EcoGamma™-g Environmental Gamma Radiation Monitor

The Mirion EcoGamma-g monitor is an advanced, dual detector, environmental gamma radiation monitor designed to operate in the most extreme conditions with unsurpassed accuracy, range and stability.

FEATURES

- ✓ Advanced, easy-to-deploy, environmental gamma radiation monitor designed for unattended monitoring in demanding operating conditions
- ✓ Features “Time-To-Count” technique for elimination of dead time and saturation effects
- ✓ Integrated web-server for network connectivity, PoE power
- ✓ Dual detectors for wide measurement range:
 - Dose rate to 1000 rem/hr (tested to 10,000 rem/hr)

APPLICATIONS

- ✓ Remote area surveillance
- ✓ Environmental monitoring
- ✓ Mobile detection



Pedestrian and Vehicle Portal Monitoring Systems

SPIR-Ident™ Pedestrian Spectroscopic Portal Monitor

A combined gamma and neutron spectrometric portal for site and critical infrastructure protection against radiological threats, such as intrusion of special nuclear material (SNM) or a radiological dispersion device (RDD).

FEATURES

- ✓ Highly sensitive Gamma (2 or 4 L NaI) and Neutron (BZnS) detection
- ✓ Pass-by occupancy sensor
- ✓ Audible and Visual Alert Indicators
- ✓ Network connectivity
- ✓ SpirVIEW Mobile™ Supervisory Software site security system

APPLICATIONS PEDESTRIAN, VEHICLE & CARGO MONITORING

- ✓ Large venues, events
- ✓ Transportation hubs (rail, air, ocean)



Pedestrian and Vehicle Portal Monitoring Systems

MiniSentry™ 2 Transportable Gamma Portal Monitor

The MiniSentry 2 portal monitor provides screening of pedestrians or vehicles for gamma radiation. It is designed to be quickly set up and operated with very little training or expertise in radiation detection technology. This portable system is well-suited for emergency scenarios and security applications.

FEATURES

- ✓ Rapid deployable gamma portal for emergency response
- ✓ Designed IAW FEMAREP-21 requirements
- ✓ Detectors: Two Gamma Plastic Scintillators 72 x 3 x 1.5 in.
- ✓ Detection: < 1 μ Ci Cs-137 at walking speed
- ✓ Quick and easy set-up: <20 minutes
- ✓ Assemble dimensions: 84 x 48 x 10.5 in.
- ✓ Optional:
 - Battery Extension Module
 - Extended Passage Width
 - Vehicle Monitoring Kit

APPLICATIONS

- ✓ Event monitoring
- ✓ Emergency response
- ✓ Facility security



Pedestrian and Vehicle Portal Monitoring Systems



FastTrack-Vehicle™ Vehicle Monitor

The FastTrack-Vehicle unit is a unique monitor for the screening of trucks and vehicles. It combines the FastTrack algorithm with large area, highly sensitive GammaFibre™ detectors. Through the use of specially developed filtering programs, the possibility of false alarms is reduced to almost zero making it the ideal choice for any location trying to screen trucks and vehicles.

FEATURES

- ✓ Gamma Fiber and optional Neutron (LZnS) detection
- ✓ Advanced FastTrack algorithm to prevent false alarms
- ✓ High sensitivity with constant performance up to 12 mph
- ✓ NORM recognition
- ✓ Web server interface for remote services
- ✓ Source localization within vehicle

APPLICATIONS

- ✓ Vehicle/truck/cargo screening
- ✓ Metal/Scrap yards



FastTrack-Vehicle (FTV) monitors

Remote Situational Awareness

A “Common Operational Platform” for networking data from fixed and mobile radiation detection systems Integrating Wi-Fi, Cellular and Ether-networked based communications.



SIGMA



SpirVIEW Supervisor



**RadResponder
Network**

Remote Situational Awareness



SpirVIEW Mobile™ Supervisory Software

A supervisory software platform which networks and displays data from fixed and mobile radiation detection systems.

FEATURES

- ✓ Real-time On-Board Identification Monitoring and Mapping
- ✓ Cellular or Wi-Fi enables real-time reachback

APPLICATIONS

- ✓ Background and contamination mapping
- ✓ Source Search
- ✓ Emergency response (pedestrian, vehicle screening)

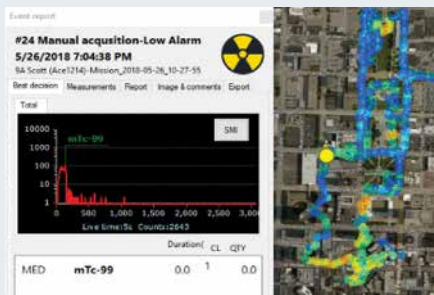

SpirVIEW Supervisor Software for Remote Command Center Monitoring and Analysis



Tactical Detection and Measurement

RDS-100P™ Radiation Detection System

RDS-100P Radiation Detection System offers comprehensive radiation management and unsurpassed reliability in a self-contained, portable system.

FEATURES

- ✓ Gamma dose rate: 0.01 mR/hr – 999 R/hr
- ✓ Beta dose rate: 0.01 mR/hr – 5 R/hr
- ✓ Alpha, beta, and X-ray count rate: 0 – 999 Kcpm
- ✓ ExtenAlpha, Beta-gamma, Beta pancake and X-ray probe
- ✓ Successor and Backward compatible with AN/PDR-77™ probe
- ✓ Can be mounted for vehicle applications
- ✓ Has dedicated NSN (National Stock Number) transferred from the PDR-77 unit



RDS-110P/110V Radiation Detection System

The RDS-1x0 meter utilizes next generation electronics system that meets and exceeds performance as the RDS-100P system.

The RDS-110 set uses the same form factor as RDS-100P and PDR-77 unit and can be mounted for vehicle applications.

FEATURES

- ✓ Familiar user interface
- ✓ True "SMART" probes can be indefinitely interchanged
- ✓ Calibration data stored in probe not meter
- ✓ Not compatible with legacy PDR-77 probes
- ✓ Powered via AA batteries with >600 hrs of battery life
- ✓ MIL-SPEC compliant



RDS-110V™ Military Radiac Set



Optional Vehicle Mount Horizontal (7083637)



Optional Vehicle Mount Vertical (D3085431)

Tactical Detection and Measurement

RGU-100™ High Sensitivity Military Pocket Radiac

This simple to operate, Military Pocket Radiac detects and quantifies prompt gamma and neutron dose as well as residual gamma dose and dose rate in support of both tactical and non-tactical use.

FEATURES

- ✓ Unique Time-to-count circuitry for accurate measurement
- ✓ Derived from the military qualified AN/UDR-13,14,15 Radiac Sets
 - Residual Gamma Radiation – 0.001 $\mu\text{Gy/hr}$ to 350 cGy/ hr dose rate and 0.001 to 999 cGy total dose
 - Prompt Neutron and Gamma Radiation – 1 to 999 cGy total dose





CDS-2000G™ Criticality Monitoring System

The CDS-2000G Criticality Monitor system provides rapid alarm for nuclear or gamma radiation leaks. It detects and immediately responds to the criticality event of minimum concern as defined by ANSI, and enables remote reset capabilities. In addition, the CDS-2000G unit will also detect and display steady state gamma radiation by utilizing a separate GM tube detector.

FEATURES

- ✓ Major components: Gamma Detector, Control Units, 2 Remote Indicators and Alarm Reset.
- ✓ Range to 2000 R/hr
- ✓ 2-second reading updates
- ✓ RS-485 Communication
- ✓ Visual LED Beacon and Audible Sounder
- ✓ 10 hour Battery Backup
- ✓ MIL-STD 461 and 810G Compliance

Tactical Detection and Measurement

Shore Based Air Particulate Detector (APD)

The Shore Based APD is rugged transportable for measuring particulate radioactivity concentrations in air. The APD utilizes the industry proven and trusted iCAM™ hardware.

FEATURES

- ✓ iCAM moving filter
- ✓ MIL-SPEC tested and qualified
- ✓ All-in-one system for easy deployment

APPLICATIONS

- ✓ Labs
- ✓ Defense
- ✓ Industrial



NASRAMS™ Naval Shipboard Radiation Monitoring System

The NASRAMS system is a shipboard radiation monitoring system that provides continuous real-time radiological information on board military vessels/vehicles. It provides detection and measurement of prompt gamma and prompt neutron dose, along with residual gamma dose rates.

FEATURES

- ✓ Gamma dose rate (Residual) 0.01 $\mu\text{Gy/hr}$ to 10 Gy/hr
- ✓ Gamma dose (Residual) 0.001 μGy to 10 Gy
- ✓ Mixed gamma/neutron dose (prompt) 5 cGy to 10 Gy
- ✓ Detector will not saturate in gamma fields to 10 Gy/hr
- ✓ Realistic training exercises available with programmable radiation simulation functionality

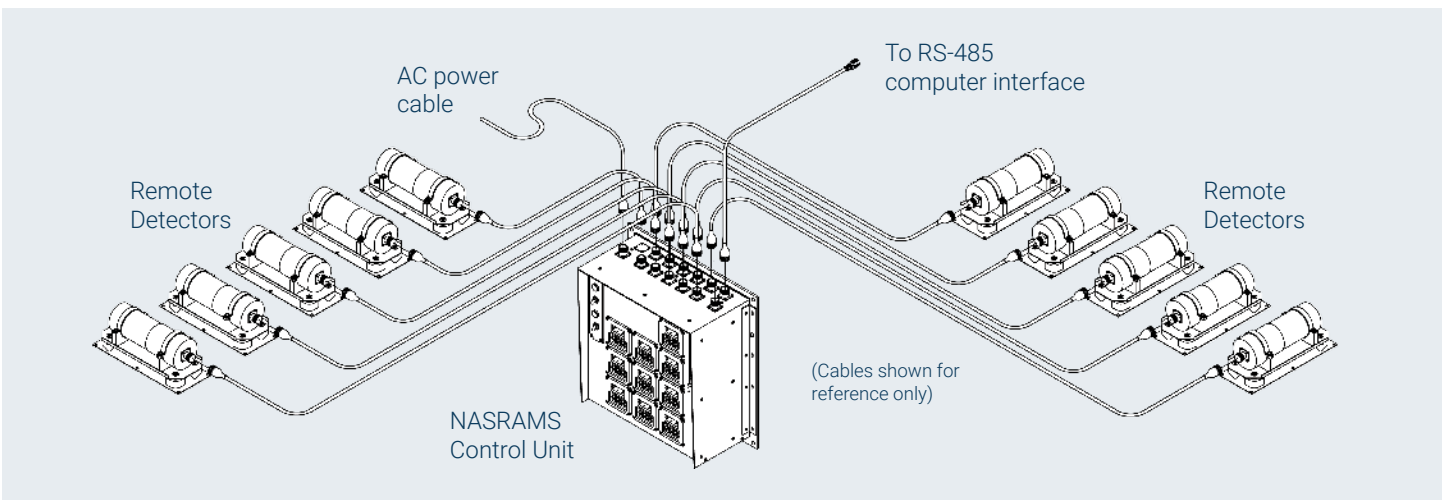

Innovative Solutions

AccuRad™ PRD-SIM Kit

Train for realistic radiation or nuclear detection and response, without the burden and hazards of real radioactive sources. The AccuRad-SIM perfectly mimics the AccuRad ergonomics and behavior, with slightly increased thickness. Trainees can experience covert hands-free detection and monitoring.

FEATURES

- ✓ Source-less training:
 - Search
 - Directional Radar
 - Low-High-Danger Dose Rates
 - Audible, Visual, and Vibration alarming
- ✓ Simulates full radiation level range – from background to nuclear event
- ✓ Train on radiation spread patterns: dynamic plume, deposition or hotspot models, with optional PlumeSIM extension
- ✓ Enable seamless communication over the AccuRad app in preparation for real-world events:
 - Alignment using Reachback capabilities (email, SMS, others including pictures and comments)
 - SpirVIEW Mobile™ situational awareness software with real-time follow-up, alarm analysis, and mapping
 - Experience using RadResponder and CBRNResponder



APPLICATIONS

- ✓ Orientation Training
- ✓ Skills requalification
- ✓ Drills/Exercises, Education
- ✓ Interdiction and Emergency Response
- ✓ Public Safety at Large Events
- ✓ Critical Infrastructure Protection
- ✓ Border Security



SIM-Teq™ System

The Sim-Teq Simulator is a training application proving realism of radiation measurement devices without radioactive sources. Sim-Teq system uses real instruments with live displays, thresholds and alarms for maximum training benefit.

FEATURES

- ✓ Simulation Control Center platform manages simulation wirelessly
- ✓ Omnidirectional antenna simulates gamma sources
- ✓ Paired instrument automatic detection
- ✓ Configurable source strength at one foot: 1.0 mR/hr to 99,000 R/hr
- ✓ ~100 ft range of detection by paired instruments (Line of Sight)
- ✓ Small and easily concealed
- ✓ LED battery charge and power indication

APPLICATIONS

- ✓ Orientation Training
- ✓ Skills requalification
- ✓ Drills/Exercises; Education

Response Kit Solutions

Fully customized to meet end-use requirements.

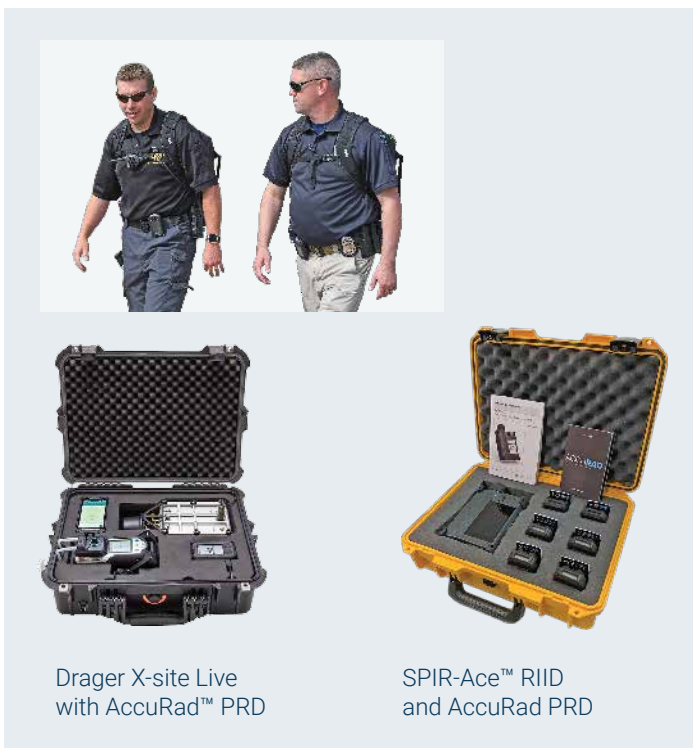

Drager X-site Live with AccuRad™ PRD

SPIR-Ace™ RIID and AccuRad PRD



Radiation Safety Homeland Security Training

Mirion's Homeland Security training programs are designed for emergency responders and others who are not radiation safety professionals. Responders should come away with an understanding of radiation, its health effects, the instruments used to detect radiation, and how to remain safe while working in a radiological environment. Most courses can be adapted to meet your needs. Please feel free to reach out for a consultation to discuss whether your organization requires a unique approach.

Radiation Safety Training Modules

These modules provide basic to advanced information about radiation and radiation safety. They include some operational topics that are common to both emergency and routine circumstances.

- ✓ Radiation Basics (1-2 hours)
- ✓ Radiation Awareness (4 hours)
- ✓ Radiation Safety Officer (40 hours)
- ✓ Radiological Health and Safety Officer (16 hours)
- ✓ Advanced Instrumentation – Theory and Operations (4 hours + exercises)

Radiation Operations Training Modules

Radiation Operations training is designed for personnel who are likely to be tasked with responding to radiological or nuclear emergencies. Students should gain understanding of some of the complexities involved in radiological interdiction and the various aspects of radiological emergency response – at the scene, at the hospital, and on a city-wide basis.

- ✓ Radiological Interdiction (8-16 hours)
- ✓ Radiological Emergency Response – Managing the City (8-16 hours)
- ✓ Radiological Emergency Response – Managing the Scene (8-16 hours)
- ✓ Radiation Safety During Medical Care giving (4-8 hours)

Radiation Instrument Training Modules

Instrument training modules are designed to help students understand how to use a specific Mirion instrument, including hands-on operations with the instrument(s). The training includes a discussion of the strengths and weaknesses of each instrument, the circumstances and situations under which it is appropriate to use each instrument, common mistakes, and more. These modules will include the Radiation Basics or the Radiation Awareness training module and can also be extended to include additional class exercises.

- ✓ UltraRadiac™-Plus Monitor (1-2 hours)
- ✓ SPIR-Ace™ RIID (1-2 hours)
- ✓ SPIR-Pack™ System (1-2 hours)
- ✓ SPIR-Ident™ Mobile Platform (2-6 hours)
- ✓ DMC 3000™ Dosimeter (1-2 hours)
- ✓ SpirVIEW Mobile™ Software (4-8 hours)
- ✓ Instrument calibration (4-8 hours)
- ✓ Radiation Dosimetry (8-16 hours)

Exercise and Practical Training Modules

The exercises and practical training modules will give students hands-on experience with their instruments. The exercises range from very simple (instrument familiarization) through complex (entering a potential “dirty bomb” lab, establishing a radiological interdiction network, and responding to a radiological incident). These exercises will help students understand how to use their instruments in both classroom and field settings.

EXERCISES

- ✓ Radiological interdiction (2-4 hours)
- ✓ Radiological crime scene management (1-2 hours)
- ✓ Radiological response (2-4 hours)

PRACTICAL TRAINING

- ✓ Instrument familiarization (30-60 minutes)
- ✓ Properties of radiation (30-60 minutes)
- ✓ Nuclide identification (30-60 minutes)
- ✓ Surveying personnel and equipment (45-90 minutes)
- ✓ Source location and identification (30-90 minutes)

Learn more about
our HLS training!





FIRE RESCUE 1

POLICE 1

Need Grant Funding for our Products?

We partner with Lexipol's Grant Assistance Program to provide assistance at no cost to help you secure grant funds for Police and Fire Rescue.

Experienced grant experts can help your agency with:

- ✓ Customized grant research
- ✓ Review of grant applications
- ✓ Weekly grant alerts
- ✓ Access to GrantFinder portal

Discounted grant writing services are also available.

Want to learn more?

Use the QR codes and fill out the GrantsHelp request forms.

A representative will be in touch soon!



Police



Fire Rescue

FOR POLICE AND FIRE RESCUE



AccuRad™ PRD
Personal Radiation Detector



SPIR-Ace™ Radio Isotope
Identification Device (RIID)



RDS-32™ Radiation
Survey Meter



AccuRad™
PRD-SIM Kit



SPIR-Pack™ Human Portable
Radiation Detection and
Identification System

FOR POLICE



DMC 3000™ Personal
Electronic Dosimeter

FOR FIRE RESCUE



UltraRadiac™-Plus
Personal Radiation Monitor

Vital Protection. Transformative Potential.™

**MIRION IS A GLOBAL LEADER IN RADIATION SAFETY,
SCIENCE AND MEDICINE.**

We offer a diverse portfolio of products and services that protects people and the planet from the harmful effects of ionizing radiation and accelerates innovation across a diversity of end markets.

The Mirion Technologies group provides proven radiation safety technologies that operate with the highest levels of precision – from R&D labs, to critical nuclear facilities, and on the front lines. In collaboration with our customers, Mirion empowers innovations that deliver vital protection and harness the transformative potential of ionizing radiation to shape our future world.





Protect What's Next™



MIRION
TECHNOLOGIES

Copyright © 2024 Mirion Technologies, Inc. or its affiliates. All rights reserved. Mirion, the Mirion logo, and other trade names of Mirion products listed herein are registered trademarks or trademarks of Mirion Technologies, Inc. or its affiliates in the United States and other countries. Third party trademarks mentioned are the property of their respective owners.

MKTG-916 - 04/2024

[MIRION.COM](https://www.mirion.com)